



EN

Cordless Impact Driver

INSTRUCTION MANUAL

DTD156



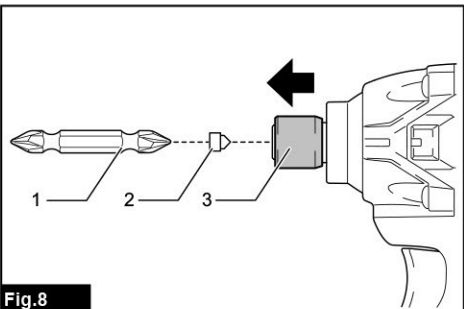
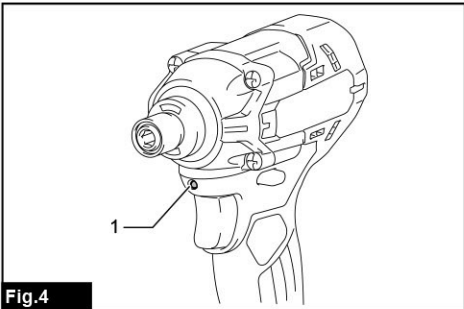
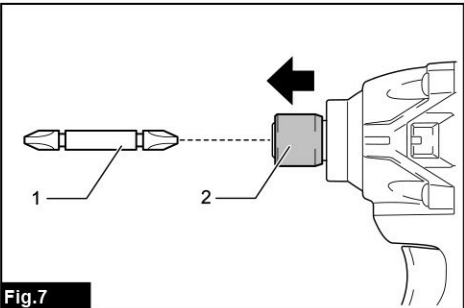
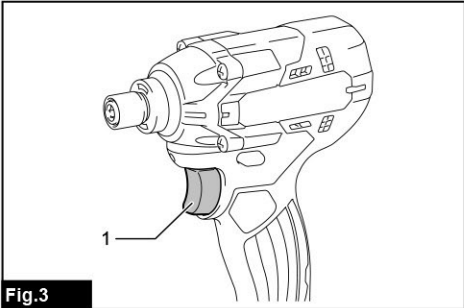
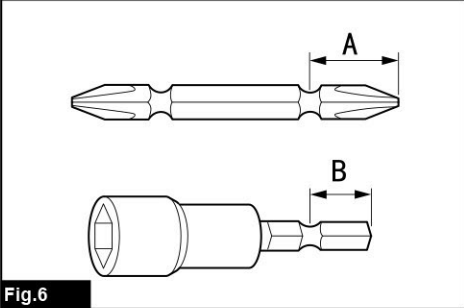
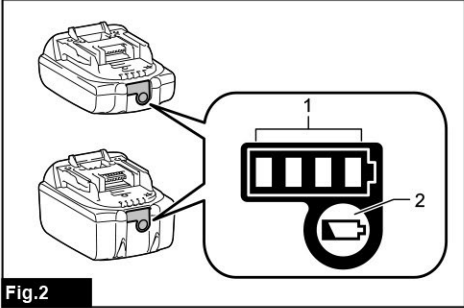
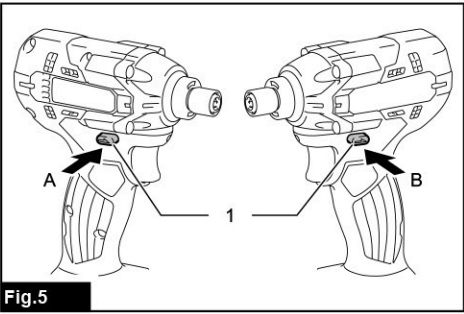
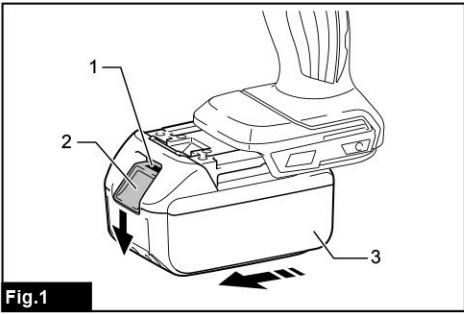

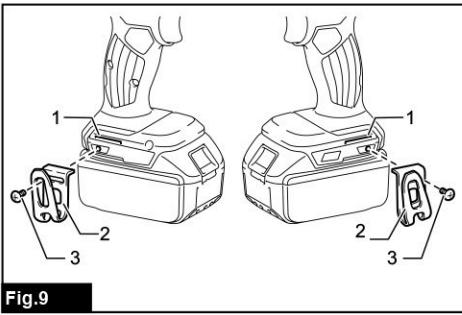

Fig.9

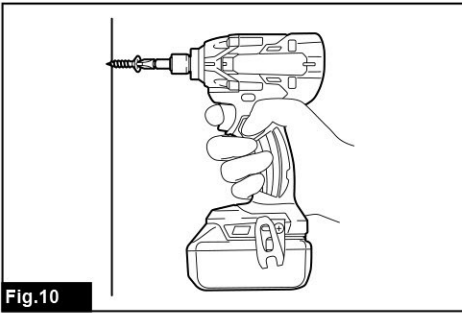

Fig.10

SPECIFICATIONS

Model:		DTD156
Fastening capacities	Machine screw	M4 - M8
	Standard bolt	M5 - M14
	High tensile bolt	M5 - M12
No load speed		0 - 2,500 min ⁻¹
Impacts per minute		0 - 3,000 min ⁻¹
Overall length		143 mm
Rated voltage		D.C. 18 V
Net weight		1.3-1.6 kg

- Due to our continuing program of research and development, the specifications herein are subject to change without notice.
- Specifications may differ from country to country.
- The weight may differ depending on the attachment(s), including the battery cartridge. The lightest and heaviest combination, according to EPTA-Procedure 01/2014, are shown in the table.

Applicable battery cartridge and charger

Battery cartridge	BL1815N / BL1820 / BL1820B / BL1830 / BL1830B / BL1840 / BL1840B / BL1850 / BL1850B / BL1860B
Charger	DC18RC / DC18RD / DC18RE / DC18SD / DC18SE / DC18SF / DC18SH

- Some of the battery cartridges and chargers listed above may not be available depending on your region of residence.

⚠WARNING: Only use the battery cartridges and chargers listed above. Use of any other battery cartridges and chargers may cause injury and/or fire.

Intended use

The tool is intended for screw driving in wood, metal and plastic.

Noise

The typical A-weighted noise level determined according to EN62841-2-2:

Sound pressure level (L_{pA}) : 92 dB(A)

Sound power level (L_{WA}) : 103 dB (A)

Uncertainty (K) : 3 dB(A)

NOTE: The declared noise emission value(s) has been measured in accordance with a standard test method and may be used for comparing one tool with another.

NOTE: The declared noise emission value(s) may also be used in a preliminary assessment of exposure.

⚠WARNING: Wear ear protection.

⚠WARNING: The noise emission during actual use of the power tool can differ from the declared value(s) depending on the ways in which the tool is used especially what kind of workpiece is processed.

⚠WARNING: Be sure to identify safety measures to protect the operator that are based on an estimation of exposure in the actual conditions of use (taking account of all parts of the operating cycle such as the times when the tool is switched off and when it is running idle in addition to the trigger time).

Vibration

The vibration total value (tri-axial vector sum) determined according to EN62841-2-2:

Work mode: impact tightening of fasteners of the maximum capacity of the tool

Vibration emission (a_h) : 10,0 m/s²

Uncertainty (K) : 1.5 m/s²

NOTE: The declared vibration total value(s) has been measured in accordance with a standard test method and may be used for comparing one tool with another.

NOTE: The declared vibration total value(s) may also be used in a preliminary assessment of exposure.

⚠WARNING: The vibration emission during actual use of the power tool can differ from the declared value(s) depending on the ways in which the tool is used especially what kind of workpiece is processed.

⚠WARNING: Be sure to identify safety measures to protect the operator that are based on an estimation of exposure in the actual conditions of use (taking account of all parts of the operating cycle such as the times when the tool is switched off and when it is running idle in addition to the trigger time).

EC Declaration of Conformity

For European countries only

The EC declaration of conformity is included as Annex A to this instruction manual.

SAFETY WARNINGS

General power tool safety warnings

⚠ WARNING: Read all safety warnings, instructions, illustrations and specifications provided with this power tool. Failure to follow all instructions listed below may result in electric shock, fire and/or serious injury.

Save all warnings and instructions for future reference.

The term "power tool" in the warnings refers to your mains-operated (corded) power tool or battery-operated (cordless) power tool.

Cordless impact driver safety warnings

1. Hold the power tool by insulated gripping surfaces, when performing an operation where the fastener may contact hidden wiring. Fasteners contacting a "live" wire may make exposed metal parts of the power tool "live" and could give the operator an electric shock.
2. Always be sure you have a firm footing. Be sure no one is below when using the tool in high locations.
3. Hold the tool firmly.
4. Wear ear protectors.
5. Do not touch the bit or the workpiece immediately after operation. They may be extremely hot and could burn your skin.
6. Keep hands away from rotating parts.
7. Use auxiliary handle(s), if supplied with the tool. Loss of control can cause personal injury.
8. Hold the power tool by insulated gripping surfaces, when performing an operation where the cutting accessory may contact hidden wiring. Cutting accessory contacting a "live" wire may make exposed metal parts of the power tool "live" and could give the operator an electric shock.

SAVE THESE INSTRUCTIONS.

⚠ WARNING: DO NOT let comfort or familiarity with product (gained from repeated use) replace strict adherence to safety rules for the subject product.

MISUSE or failure to follow the safety rules stated in this instruction manual may cause serious personal injury.

Important safety instructions for battery cartridge

1. Before using battery cartridge, read all instructions and cautionary markings on (1) battery charger, (2) battery, and (3) product using battery.
2. Do not disassemble battery cartridge.
3. If operating time has become excessively shorter, stop operating immediately. It may result in a risk of overheating, possible burns and even an explosion.
4. If electrolyte gets into your eyes, rinse them out with clear water and seek medical attention right away. It may result in loss of your eyesight.
5. Do not short the battery cartridge:
 - (1) Do not touch the terminals with any conductive material.
 - (2) Avoid storing battery cartridge in a container with other metal objects such as nails, coins, etc.
 - (3) Do not expose battery cartridge to water or rain.

A battery short can cause a large current flow, overheating, possible burns and even a breakdown.

6. Do not store the tool and battery cartridge in locations where the temperature may reach or exceed 50 °C (122 °F).
7. Do not incinerate the battery cartridge even if it is severely damaged or is completely worn out. The battery cartridge can explode in a fire.
8. Be careful not to drop or strike battery.
9. Do not use a damaged battery.
10. The contained lithium-ion batteries are subject to the Dangerous Goods Legislation requirements. For commercial transports e.g. by third parties, forwarding agents, special requirement on packaging and labeling must be observed. For preparation of the item being shipped, consulting an expert for hazardous material is required. Please also observe possibly more detailed national regulations. Tape or mask off open contacts and pack up the battery in such a manner that it cannot move around in the packaging.
11. When disposing of the battery cartridge, remove it from the tool and dispose of it in a safe place. Follow your local regulations relating to disposal of battery.
12. Use the batteries only with the products specified by Makita. Installing the batteries to non-compliant products may result in a fire, excessive heat, explosion, or leak of electrolyte.
13. If the tool is not used for a long period of time, the battery must be removed from the tool.

SAVE THESE INSTRUCTIONS.

⚠ CAUTION: Only use genuine Makita batteries. Use of non-genuine Makita batteries, or batteries that have been altered, may result in the battery bursting causing fires, personal injury and damage. It will also void the Makita warranty for the Makita tool and charger.

Tips for maintaining maximum battery life

1. Charge the battery cartridge before completely discharged. Always stop tool operation and charge the battery cartridge when you notice less tool power.
2. Never recharge a fully charged battery cartridge. Overcharging shortens the battery service life.
3. Charge the battery cartridge with room temperature at 10 °C - 40 °C (50 °F - 104 °F). Let a hot battery cartridge cool down before charging it.
4. Charge the battery cartridge if you do not use it for a long period (more than six months).

FUNCTIONAL DESCRIPTION

CAUTION: Always be sure that the tool is switched off and the battery cartridge is removed before adjusting or checking function on the tool.

Installing or removing battery cartridge

CAUTION: Always switch off the tool before installing or removing of the battery cartridge.

CAUTION: Hold the tool and the battery cartridge firmly when installing or removing battery cartridge. Failure to hold the tool and the battery cartridge firmly may cause them to slip off your hands and result in damage to the tool and battery cartridge and a personal injury.

► Fig.1: 1. Red indicator 2. Button 3. Battery cartridge

To remove the battery cartridge, slide it from the tool while sliding the button on the front of the cartridge.

To install the battery cartridge, align the tongue on the battery cartridge with the groove in the housing and slip it into place. Insert it all the way until it locks in place with a little click. If you can see the red indicator on the upper side of the button, it is not locked completely.

CAUTION: Always install the battery cartridge fully until the red indicator cannot be seen. If not, it may accidentally fall out of the tool, causing injury to you or someone around you.

CAUTION: Do not install the battery cartridge forcibly. If the cartridge does not slide in easily, it is not being inserted correctly.

Battery protection system

The tool is equipped with a battery protection system. This system automatically cuts off power to the motor to extend battery life.

The tool will automatically stop during operation if the tool and/or battery are placed under one of the following conditions:

Overloaded:

The tool is operated in a manner that causes it to draw an abnormally high current.

In this situation, turn the tool off and stop the application that caused the tool to become overloaded. Then turn the tool on to restart.

If the tool does not start, the battery is overheated. In this situation, let the battery cool before turning the tool on again.

Low battery voltage:















The remaining battery capacity is too low and the tool will not operate. In this situation, remove and recharge the battery.

Indicating the remaining battery capacity

Only for battery cartridges with the indicator

► Fig.2: 1. Indicator lamps 2. Check button

Press the check button on the battery cartridge to indicate the remaining battery capacity. The indicator lamps light up for a few seconds.

Indicator lamps			Remaining capacity
 Lighted	 Off	 Blinking	
			75% to 100%
			50% to 75%
			25% to 50%
			0% to 25%
			Charge the battery.
			The battery may have malfunctioned.

NOTE: Depending on the conditions of use and the ambient temperature, the indication may differ slightly from the actual capacity.

Switch action

► Fig.3: 1. Switch trigger

⚠ CAUTION: Before installing the battery cartridge into the tool, always check to see that the switch trigger actuates properly and returns to the "OFF" position when released.

To start the tool, simply pull the switch trigger. Tool speed is increased by increasing pressure on the switch trigger. Release the switch trigger to stop.

Lighting up the front lamp

► Fig.4: 1. Lamp

⚠ CAUTION: Do not look in the light or see the source of light directly.

Pull the switch trigger to light up the lamp. The lamp keeps on lighting while the switch trigger is being pulled. The lamp goes out approximately 10 seconds after releasing the switch trigger.

NOTE: Use a dry cloth to wipe the dirt off the lens of the lamp. Be careful not to scratch the lens of lamp, or it may lower the illumination.

Reversing switch action

► Fig.5: 1. Reversing switch lever

⚠ CAUTION: Always check the direction of rotation before operation.

⚠ CAUTION: Use the reversing switch only after the tool comes to a complete stop. Changing the direction of rotation before the tool stops may damage the tool.

⚠ CAUTION: When not operating the tool, always set the reversing switch lever to the neutral position.

This tool has a reversing switch to change the direction of rotation. Depress the reversing switch lever from the A side for clockwise rotation or from the B side for counterclockwise rotation.

When the reversing switch lever is in the neutral position, the switch trigger cannot be pulled.

ASSEMBLY

⚠ CAUTION: Always be sure that the tool is switched off and the battery cartridge is removed before carrying out any work on the tool.

Installing or removing driver bit/socket bit

► Fig.6

Use only driver bit/socket bit that has inserting portion shown in the figure. Do not use any other driver bit/socket bit.

For tool with shallow driver bit hole

A=12mm B=9mm	Use only these type of driver bit. Follow the procedure 1. (Note) Bit-piece is not necessary.
-----------------	---

For tool with deep driver bit hole

A=17mm B=14mm	To install these types of driver bits, follow the procedure 1.
A=12mm B=9mm	To install these types of driver bits, follow the procedure 2. (Note) Bit-piece is necessary for installing the bit.

Procedure 1

For tool without one-touch type sleeve

► Fig.7: 1. Driver bit 2. Sleeve

To install the driver bit, pull the sleeve in the direction of the arrow and insert the driver bit into the sleeve as far as it will go.

Then release the sleeve to secure the driver bit.

For tool with one-touch type sleeve

To install the driver bit, insert the driver bit into the sleeve as far as it will go.

Procedure 2

Optional accessory

In addition to **Procedure 1**, insert the bit-piece into the sleeve with its pointed end facing in.

► Fig.8: 1. Driver bit 2. Bit-piece 3. Sleeve

To remove the driver bit, pull the sleeve in the direction of the arrow and pull the driver bit out.

NOTE: If the driver bit is not inserted deep enough into the sleeve, the sleeve will not return to its original position and the driver bit will not be secured. In this case, try re-inserting the bit according to the instructions above.

NOTE: When it is difficult to insert the driver bit, pull the sleeve and insert it into the sleeve as far as it will go.

NOTE: After inserting the driver bit, make sure that it is firmly secured. If it comes out, do not use it.

Installing hook

⚠ CAUTION: When installing the hook, always secure it with the screw firmly. If not, the hook may come off from the tool and result in the personal injury.

► Fig.9: 1. Groove 2. Hook 3. Screw

The hook is convenient for temporarily hanging the tool. This can be installed on either side of the tool. To install the hook, insert it into a groove in the tool housing on either side and then secure it with a screw. To remove, loosen the screw and then take it out.

OPERATION

► Fig.10

The proper fastening torque may differ depending upon the kind or size of the screw/bolt, the material of the workpiece to be fastened, etc. The relation between fastening torque and fastening time is shown in the figures.

Proper fastening torque for standard bolt

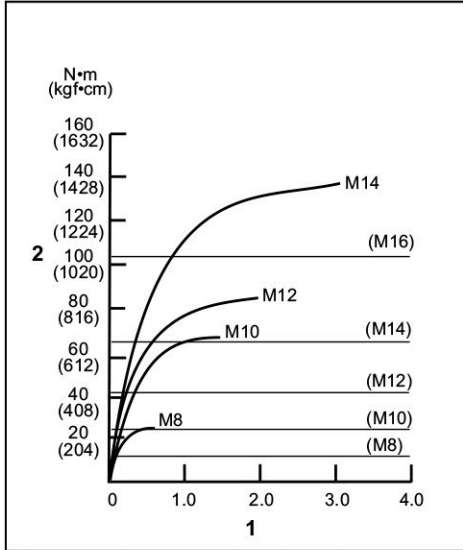

1. Fastening time (second) 2. Fastening torque

Proper fastening torque for high tensile bolt

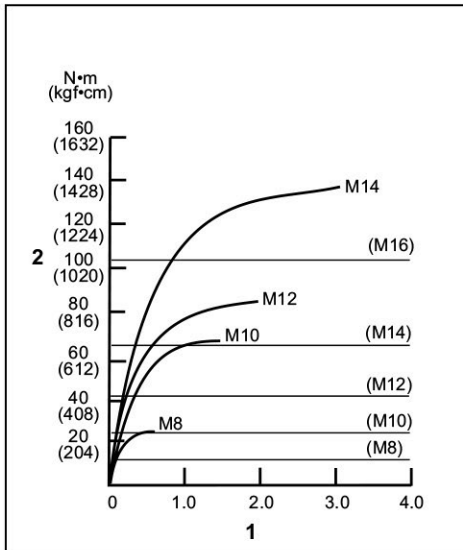

1. Fastening time (second) 2. Fastening torque

Hold the tool firmly and place the point of the driver bit in the screw head. Apply forward pressure to the tool to the extent that the bit will not slip off the screw and turn the tool on to start operation.

NOTICE: If you use a spare battery to continue the operation, rest the tool at least 15 min.

NOTE: Use the proper bit for the head of the screw/bolt that you wish to use.

NOTE: When fastening M8 or smaller screw, carefully adjust pressure on the switch trigger so that the screw is not damaged.

NOTE: Hold the tool pointed straight at the screw.

NOTE: If the impact force is too strong or you tighten the screw for a time longer than shown in the figures, the screw or the point of the driver bit may be overstressed, stripped, damaged, etc. Before starting your job, always perform a test operation to determine the proper fastening time for your screw.

The fastening torque is affected by a wide variety of factors including the following. After fastening, always check the torque with a torque wrench.

1. When the battery cartridge is discharged almost completely, voltage will drop and the fastening torque will be reduced.
2. Driver bit or socket bit
Failure to use the correct size driver bit or socket bit will cause a reduction in the fastening torque.
3. Bolt
 - Even though the torque coefficient and the class of bolt are the same, the proper fastening torque will differ according to the diameter of bolt.
 - Even though the diameters of bolts are the same, the proper fastening torque will differ according to the torque coefficient, the class of bolt and the bolt length.
4. The manner of holding the tool or the material of driving position to be fastened will affect the torque.
5. Operating the tool at low speed will cause a reduction in the fastening torque.

MAINTENANCE

CAUTION: Always be sure that the tool is switched off and the battery cartridge is removed before attempting to perform inspection or maintenance.

NOTICE: Never use gasoline, benzine, thinner, alcohol or the like. Discoloration, deformation or cracks may result.

To maintain product SAFETY and RELIABILITY, repairs, carbon brush inspection and replacement, any other maintenance or adjustment should be performed by Makita Authorized or Factory Service Centers, always using Makita replacement parts.

OPTIONAL ACCESSORIES

⚠ CAUTION: These accessories or attachments are recommended for use with your Makita tool specified in this manual. The use of any other accessories or attachments might present a risk of injury to persons. Only use accessory or attachment for its stated purpose.

If you need any assistance for more details regarding these accessories, ask your local Makita Service Center.

- Driver bits
- Bit piece
- Hook
- Plastic carrying case
- Makita genuine battery and charger
- Battery protector

NOTE: Some items in the list may be included in the tool package as standard accessories. They may differ from country to country.

Makita Europe N.V. Jan-Baptist Vinkstraat 2,
3070 Kortenberg, Belgium

Makita Corporation 3-11-8, Sumiyoshi-cho,
Anjo, Aichi 446-8502 Japan

www.makita.com

885747-992 EN, FR, DE, IT, NL, ES, PT, DA, EL, TR 20190801
