

®

Makita

2023

ACCESSORY CATALOGUE



Safety Precautions

When using electric tools, basic safety precautions should always be followed to reduce the risk of fire, electric shock, and personal injury, including the following.

/// KEEP WORK AREA CLEAN.

Cluttered areas and benches invite injuries.

/// CONSIDER WORK AREA ENVIRONMENT.

Don't use power tools in damp or wet locations. Keep work area well lit. Don't expose power tools to rain. Don't use power tool in presence of flammable liquids or gases.

/// KEEP CHILDREN AWAY.

All visitors should be kept away from work area. Don't let visitors touch the tool or extension cord.

/// STORE IDLE TOOLS.

When not in use, tools should be stored in a dry, high of locked up place, out of reach of children.

/// DON'T FORCE THE TOOL.

It will do the job better and safer at the rate for which it was intended.

/// USE THE RIGHT TOOL.

Don't force small tools or attachments to do the job of a heavy-duty tool. Don't use tools for purposes not intended.

/// DRESS PROPERLY.

Don't wear loose clothing or jewelry. They can be caught in moving parts. Rubber gloves and non-skid footwear are recommended when working outdoors. Wear protective hair covering to contain long hair.

/// USE SAFETY GLASSES.

Also use face or dust mask if the cutting operation is dusty.

/// DON'T ABUSE THE CORD.

Never carry the tool by the cord or yank it to disconnect it from the socket. Keep the cord away from heat, oil, and sharp edges.

/// SECURE WORK.

Use clamps or a vise to hold the work. It's safer than using your hand and it frees both hands to operate the tool.

/// DON'T OVERREACH.

Keep proper footing and balance at all times.

/// MAINTAIN TOOLS WITH CARE.

Keep cutting tools sharp and clean for better and safer performance. Follow instructions for lubrication and changing accessories. Inspect tool cord periodically and if damaged, have it repaired by an authorized service facility. Inspect extension cords periodically and replace, if damaged. Keep handles dry, clean and free from oil and grease.

/// DISCONNECT TOOLS.

When not in use, before servicing and when changing accessories such as blades, bits and cutters.

/// REMOVE ADJUSTING KEYS AND WRENCHES.

Form the habit of checking to see that keys and adjusting wrenches are removed from the tool before turning it on.

/// AVOID UNINTENTIONAL STARTING.

Don't carry a plugged-in tool with a finger on the switch. Ensure switch is OFF when plugging in.

/// USE OUTDOOR EXTENSION CORDS.

When tool is used outdoors, use only extension cords intended for outdoor use.

/// STAY ALERT.

Watch what you are doing. Use common sense. Don't operate tool when you are tired.

/// CHECK DAMAGED PARTS.

Before further use of the tool, a guard or other part that is damaged should be carefully checked to determine that it will operate properly and perform its intended function. Check for alignment of moving parts, free running of moving parts, breakage of parts, mounting and any other conditions that may affect its operation. A guard or other part that is damaged should be properly repaired or replaced by an authorized service center unless otherwise indicated in this instruction manual. Have defective switches replaced by an authorized service facility. Don't use the tool if the switch does not turn it on and off.

/// GUARD AGAINST ELECTRIC SHOCK.

Avoid body contact with earthed or grounded surfaces (e.g. pipes, radiators, ranges, refrigerators).

/// REPLACEMENT PARTS.

When servicing a tool, use only identical replacement parts.

/// VOLTAGE WARNING:

Before connecting the tool to a power source (receptacle, outlet, etc.) Be sure the voltage supplied is the same as that specified on the nameplate of the tool. A power source with voltage greater than that specified for the tool can result in SERIOUS INJURY to the user V as well as damage to the tool. If in doubt, DO NOT PLUG IN THE TOOL. Using a power source with voltage less than the nameplate rating is harmful to the motor.

Note

- Makita reserves the right to change specifications of parts and accessories without notice.
- Items of standard equipment and specifications may vary by country or area.
- Net weight and dimensions may differ by the type of battery.
- Standard export color for motor housing is Makita industrial green (blue).
- Please state required voltage when ordering. These offers are subject to availability in each country. Actual product color may differ slightly from color reproduced here.
- The weight may differ depending on the attachment(s), including the battery cartridge. The lightest and heaviest combination, according to EPTA-Procedure 01/2014

Guarantee

Every Makita tool is thoroughly inspected and tested before leaving the factory. It is guaranteed against defective workmanship and materials. Should any trouble develop, return the COMPLETE tool prepaid to Makita or point of purchase. If inspection shows trouble is caused by defective workmanship of material, all repairs will be made without charge. The guarantee does not apply where repairs have been made or attempted by others; repairs are due to normal wear; the tool has been abused or in an accident; misuse is evident – caused by overloading the tool beyond its capacity, use of the tool after partial failure or use with improper accessories.

Safety



Wear eye protection



Wear ear protection



Wear a mask



Wear protective gloves



Wear protective shoes



Read the instruction manuals



Remove plug from socket

Materials

Masonry



Reinforced concrete



Concrete



Aerated concrete



Brick



Soft brick



Stone



Limestone



Marble



Granite

Wood



Wood



Wood with nails



Laminate board



Plywood



Chipboard



MDF

Metal



Metal



Sheet metal



Non-ferrous metals



Aluminum



Stainless steel



Cast iron

Other Materials



Glass fibre reinforced plastic, epoxy



Glass



Plastic



Ceramic tiles



Soft Tile



Fiber cement board



Plaster board



Epoxy



Cardboard



Cork



Asphalt



Rubber



Leather



Ice

Drilling (Wood/Metal) 10



Drilling (Masonry) 39



Fastening 64



Drill and Screw Bit Sets 77



Cutting 80



Jigsaw / Reciprosawing 96



Brushing 109



Bonded Abrasive 116



Coated Abrasive 128



Multi Tool 141



Diamond 152



Planing / Routing 172



OPE 181



Miscellaneous 199



Screwing/Drilling

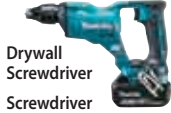

Fastening P.64

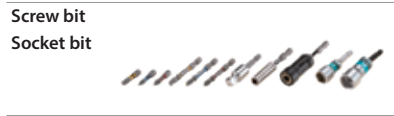

Drilling (Wood/Metal) P.10

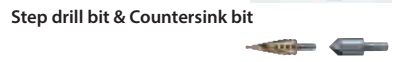
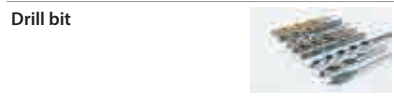

Brushing P.109



Drilling (Masonry) P.39



Diamond P.152



Fastening P.64



Drilling (Wood/Metal) P.10



Drilling (Masonry) P.39

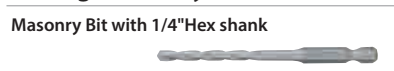

Fastening P.64



Fastening P.64



Miscellaneous P.199



Stirring



Miscellaneous P.199



Hammer drilling/Chiselling



Drilling (Wood/Metal) P.10



Diamond P.152

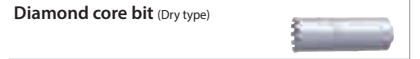

Drilling (Masonry) P.39

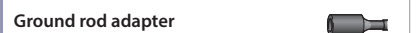
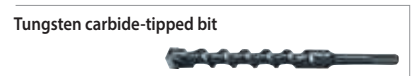

Cutting



Diamond P.152



Bonded Abrasive P.116



Cutting P.80



Jigsaw / Reciprosawing P.96



Grinding/Sanding/Polishing

Angle Grinder



Bonded Abrasive P.116

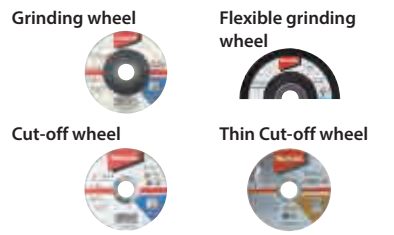

Coated Abrasive P.128

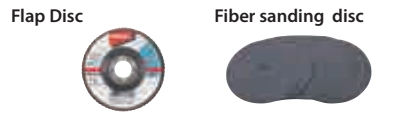

Brushing P.109



Diamond P.152



Die Grinder



Bonded Abrasive P.116

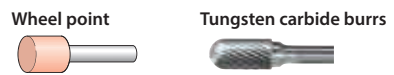

Coated Abrasive P.128



Disc Sander



Belt Sander



Finishing Sander



Random Orbit Sander



Polisher



Brushing P.109



Stone Polisher



Wheel Sander



Brushing P.109



Bench Grinder
Straight Grinder



Bonded Abrasive P.116



Multifunction

Multi Tool



Multi Tool P.141



Sawing

Slide Compound Miter Saw
Circular Saw
Table Saw



Cutting P.80



Jig saw



Jigsaw / Reciprosawing P.96



Reciprosaw



Band saw



Milling/Planing

Planer



Planing / Routering P.172



Trimmer
Router



Concrete Planer



Diamond P.152



Outdoor Power Equipment



P.181

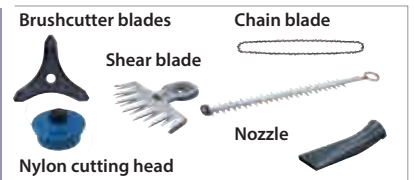

Miscellaneous



Hand Tool , Pouches & Holders P.199



Pneumatic Tool P.199



Ideal for Cordless Tool Accessories



What is Ideal for DC tool Accessories ?

Provides the greatest performance on DC tools!

Higher speed, more work amount on a single full battery charge and a nice sense of use.* Here are the parties which give you the greatest performance on your MAKITA DC tools. You can find recommended accessories for DC tools with DC tool icons with an emphasized battery symbol. Try and see MAKITA's leading-edge technology.

*Features may vary by item.





TCT saw blade EFFICUT series

EFFICUT



Efficient Sharp Tip's Top Angle



Efficient Curved Tip's Body



Efficient Slimmed Bottom



The amount of cutting per 1 charge

Current (165mm x 48T)	100	140% UP
Ideal for DC (165mm x 56T)	240	

EFFICUT Composite decking

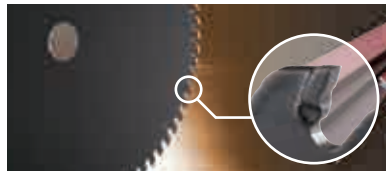

Efficient Curved Tip's Body



Efficient Slimmed Bottom



The amount of cutting per 1 charge

Current (180mm x 40T)	100	30% UP
Ideal for DC (185mm x 40T)	130	

EFFICUT Metal

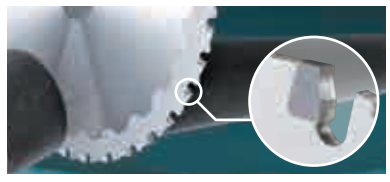

Strong and least chipping



Release swarf smoothly



Superior in straight cutting



The amount of cutting per 1 charge

Current (150mm x 32T)	100	60% UP
Ideal for DC (150mm x 33T)	160	

EFFICUT Aluminum



Strong and least chipping



Reduce cutting resistance



Superior in straight cutting

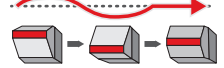

Release swarf smoothly



The amount of cutting per 1 charge

Current (260mm x 80T)	100	40% UP
Ideal for DC (260mm x 81T)	140	



Diamond wheel for concrete

Specialized for 9inch DC Power Cutter

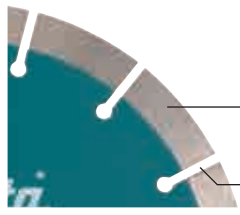

To reduce the cutting load, diamond grain size is designed small.

The narrower slits reduce dragging work pieces.



The amount of cutting per 1 charge

Current	100	65% UP
Ideal for DC	165	



Cut-off wheel for Power cutter / Metal / Ideal for Cordless Power cutter

Specialized for 14inch DC Power Cutter



Ideal blend of abrasive grain and bond for Cordless power cutter.

The amount of cutting per 1 charge

Current	100	10% UP
Ideal for DC	110	



Thin cut-off wheel

0.8mm thickness for fast cutting

Thinner thickness

0.8mm thinner thickness brings ... fast cutting / reduction of cutting resistance / less burr of materials / less dust of materials

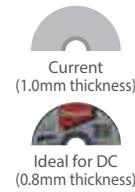

The amount of cutting per 1 charge

100

20% UP

120

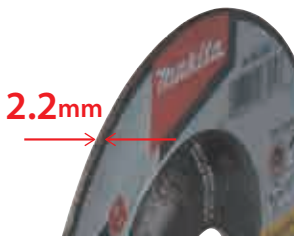

2in1 grinding wheel

Cutting and deburring are possible in one disc

Specialized cutting work

Thanks to "SA" grid and 2.2mm thinner thickness, it enables you to cut fast and deburring safety.

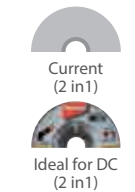

The amount of cutting per 1 charge

100

15% UP

115



Flexible grinding wheel

Low vibration and no need back-up pad

Shock absorbed structure

Added shock absorbing material. You can feel overwhelmingly low vibration. Grinding speed is also faster because of its flexibility. It can touch materials more efficiency.

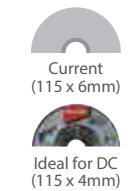

The amount of cutting per 1 charge

100

70% UP

170

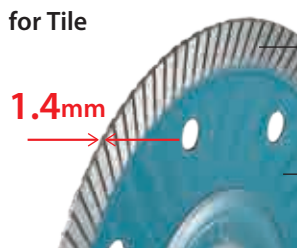

Thin diamond wheel

Smooth & light cutting

Thinner thickness & enough strength

1.4mm thickness able to get smooth and light cutting.

Corrugated Rim increases wheel tension and reduces vibration during the cut.

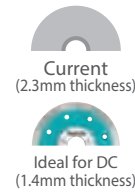

The amount of cutting per 1 charge

100

60% UP

160

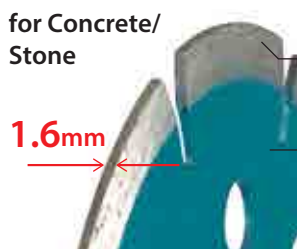

Specialized cutting work

This blade is designed as 1.6mm. So smooth and light cutting is available.

It was lightened by punching the body. It is also reduce the load on the battery and increased the cutting distance per 1 battery charge.



The amount of cutting per 1 charge

100

50% UP

150



Abrasive Cut-off wheel for metal stud

Specialized for 14inch DC Portable Cut-off

Thinner blade & the optimum bonding

2.5mm thickness blade for smooth and fast cutting. The optimum bonding for fast cutting and longer life.

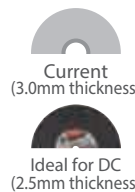

The amount of cutting per 1 charge

100

30% UP

130



Impact PREMIER



High Precision Screw Fitting.

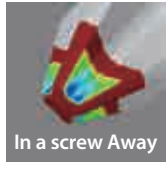

Double Torsion for High Durability.



New Steel is Used. Supports High Torque.

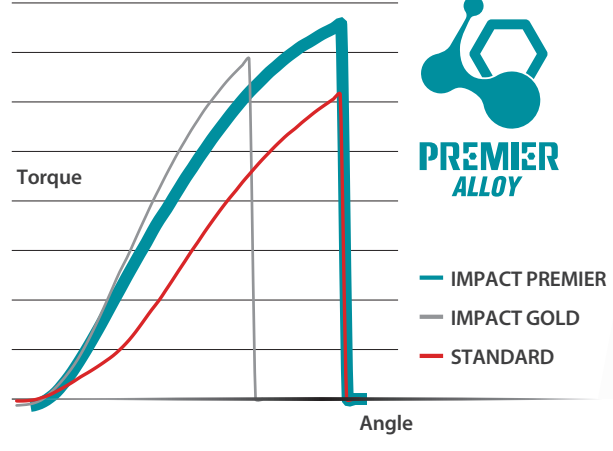

Four-leaf Nylon cord **Four-Leaf Line**

Low noise and energy saving

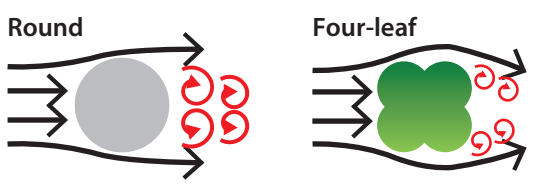

Four-leaf shape makes small vortex and realizes low noise and energy saving feature thanks to less air resistance.

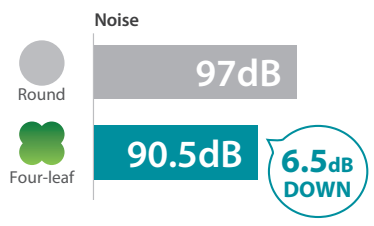
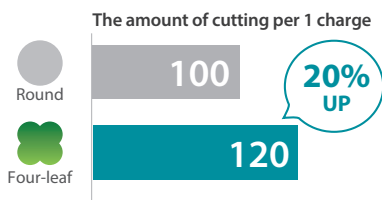

80 series saw chain **NEW**

1. Optimum cutter shape for smooth cutting

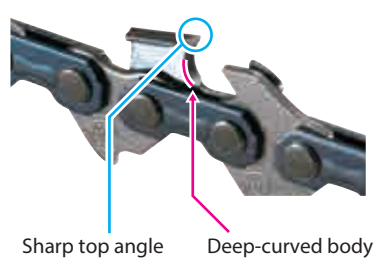

2. Short pitch for less vibration

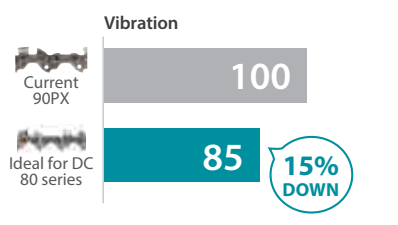
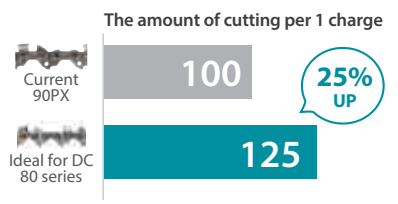
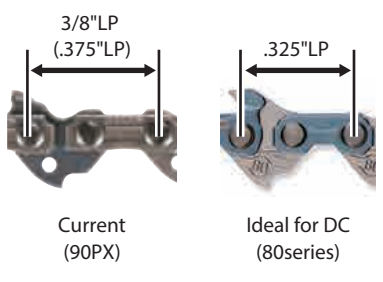

ACCESSORIES

Drilling (Wood/Metal)



Metal, mild steel



Stainless steel



Aluminum



Non-ferrous metal



Wood



Wood with nails



MDF



Plywood



Tile



Soft Tile



Brick



Soft brick



Marble



Concrete



Granite



Limestone



Plaster board



Plastic



Fiberglass



Sheet metal



Tungsten carbide tip for glass bit



Glass



Long life



Fast cut



n max. 10000



Chisel edge



M shape



Split point

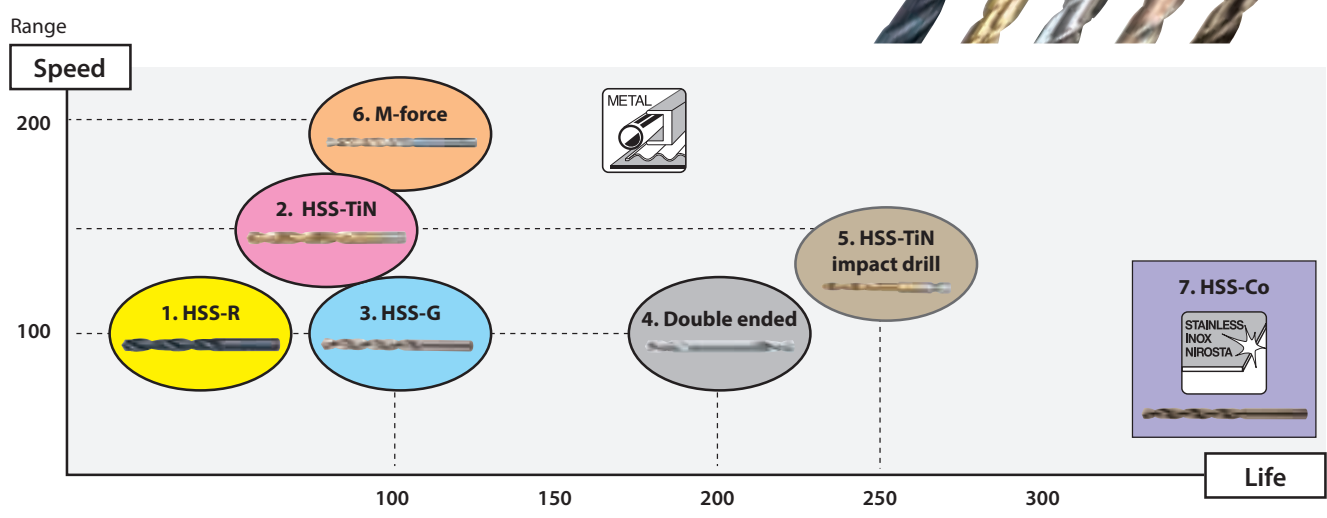
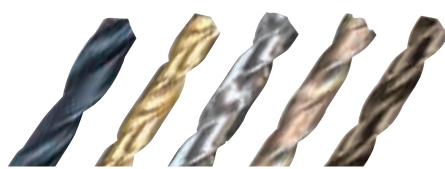

No.	1	2	3	4	5	6	7
Range	★	★★	★★★	★★★★	★★★★★	★★★★★	Specialized
Series							
Description	HSS-R	HSS-TiN	HSS-G	Double ended	HSS-TiN impact drill	M-force	HSS-Co5%
Made of							
Process of manufacturing *	Roll forged 	Ground 					
Tip geometry **	Chisel edge 118° 	Split point 135° 	Chisel edge 118° 	Split point 135° 	M-shape 	Split point 135° 	
Surface	Black oxide finish Anti-rust	TiN coating Long life	Bright finish 		TiN coating Long life	Amber finish Anti-rust	
Shank	Straight (Cylindrical) 				1/4"Hex (E-form) 	Straight (Three flat) Better grip than Cylindrical shank	Straight (Cylindrical)































		AA : Recommended					A : Acceptable	
No.		1	2	3	4	5	6	7
Material	Wood	A	A	A	A	A	A	
	Plastic	AA	AA	AA	AA	AA	AA	
	Non-ferrous metal***		AA	AA	AA	AA	AA	A
	Sheet steel	A	AA	AA	AA	AA	AA	A
	Cast iron	AA	AA	AA	AA	AA	AA	AA
	Alloy steel		AA	AA	AA	AA	AA	AA
	Stainless steel		A	A	A	A	A	AA

* Roll forged: Made by die-casted rolling machine. It is economical price.
Ground: Drill bits ground from the block with excellent surface quality.

** 135°split point: Ensure no walking and start fast, on contact.
M-shape: Designed to focus on drilling smoothly and speedily.

*** Non-ferrous metal (Such as Copper, Nickel and Zinc)

HSS metal drill bit line up

Series	Shank	Single pkg.	Set	Assortment					
		1pc. / 2pcs.	5pcs. / 10pcs.						
HSS-R	Straight (Cylindrical)	 1pc. / 2pcs.	 5pcs. / 10pcs. set	 13pcs. set	 19pcs. set	 25pcs. set			
HSS-TiN	Straight (Cylindrical)	 1pc. / 2pcs.	 5pcs. / 10pcs. set	 6pcs. set	 10pcs. set	 13pcs. set	 19pcs. set	 25pcs. set	 19pcs. set
HSS-G	Straight (Cylindrical)	 1pc.	 5pcs. / 10pcs. set	 6pcs. set	 19pcs. set	 25pcs. set	 13pcs. set	 19pcs. set	 25pcs. set
HSS-TiN	1/4" Hex (E-form)	 1pc.				 5pcs. set			
M-force	Straight (Three flat)	 1pc.			 19pcs. set	 25pcs. set			
HSS-Co	Straight (Cylindrical)	 1pc.	 5pcs. set	 6pcs. set	 19pcs. set	 25pcs. set			



Metal drill bit HSS-R



Range	Diameter mm	Length mm	Working Length mm	Sales Pkg Qty	Part No.
	1	34	12	2	D-38283
				10	D-38532
	1.5	40	18	2	D-38299
				10	D-38548
	2	49	24	2	D-38308
				10	D-38554
	2.5	57	30	2	D-38314
				10	D-38560
	2.6	57	30	2	D-38320
				2	D-46931
	2.9	61	33	10	D-46872
				2	D-38336
	3	61	33	10	D-38576
				2	D-38342
	3.2	65	36	10	D-38582
				2	D-46713
	3.3	65	36	10	D-46698
				2	D-38358
	3.5	70	39	10	D-38598
				2	D-38364
	4	75	43	10	D-38607
				1	D-38370
	4.2	75	43	10	D-38613
				1	D-38386
	4.5	80	47	10	D-38629
				1	D-38392
	4.8	86	52	10	D-38635
				1	D-38401
	5	86	52	10	D-38641
				1	D-46729
	5.2	86	52	10	D-46707
				1	D-46947
	5.3	86	52	10	D-46888
				1	D-38417
★☆☆☆☆	5.5	93	57	10	D-38657
				1	D-38423
	6	93	57	10	D-38663
				1	D-38439
	6.5	101	63	10	D-38679
				1	D-46953
	6.8	109	69	10	D-46894
				1	D-38445
	7	109	69	10	D-38685
				1	D-38451
	7.5	109	69	10	D-38691
				1	D-38467
	8	117	75	10	D-38700
				1	D-38473
	8.5	117	75	10	D-38716
				1	D-46969
	8.8	125	81	10	D-46903
				1	D-38489
	9	125	81	10	D-38722
				10	D-38738
	9.5	125	81	1	D-38495
				10	D-38744
	10	133	87	1	D-46975
				5	D-46919
	10.5	133	87	5	D-38750
				1	D-46981
	10.8	142	94	5	D-46925
				1	D-38504
	11	142	94	5	D-38766
				5	D-38772
	11.5	142	94	1	D-38510
				5	D-38788
	12	151	101	5	D-38794
				1	D-38526
	12.5	151	101	5	D-38803
				5	

Metal drill bit HSS-R assortment in metal case



Range	Diameter mm	Sales Pkg Qty	Part No.
★☆☆☆☆	1.5 to 6.5	13	D-54075
	1 to 10	19	D-54081
	1 to 13	25	D-54097

Metal drill bit HSS-TiN



Range	Diameter mm	Length mm	Working Length mm	Shank dia. mm	Sales Pkg Qty	Part No.
	1	34	12	1	2	D-64004
					10	D-64250
	1.5	40	18	1.5	2	D-64010
					10	D-64266
	2	49	24	2	2	D-64026
					10	D-64272
	2.5	57	30	2.5	2	D-64032
					10	D-64288
	3	61	33	3	2	D-64048
					10	D-64294
	3.5	70	39	3.5	2	D-64054
					10	D-64303
	4	75	43	4	2	D-64060
					10	D-64319
	4.5	80	47	4.5	1	D-64076
					10	D-64325
	5	86	52	5	1	D-64082
					10	D-64331
	5.5	93	57	5.5	1	D-64098
					10	D-64347
	6	93	57	6	1	D-64107
					10	D-64353
	6.5	101	63	6.5	1	D-64113
					10	D-64369
★☆☆☆☆	7	109	69	7	1	D-64129
					10	D-64375
	7.5	109	69	7.5	1	D-64135
					10	D-64381
	8	117	75	8	1	D-64141
					10	D-64397
	8.5	117	75	8.5	1	D-64157
					5	D-64406
	9	125	81	9	1	D-64163
					5	D-64412
	9.5	125	81	9.5	1	D-64179
					5	D-64428
	10	133	87	10	1	D-64185
					5	D-64434
	10.5	133	87	10.5	1	D-64191
					5	D-64440
	11	142	94	11	1	D-64200
					5	D-64456
	11.5	142	94	11.5	1	D-64216
					5	D-64462
	12	151	101	12	1	D-64222
					5	D-64478
	12.5	151	101	12.5	1	D-64238
					5	D-64484

Range	Diameter mm	Length mm	Working Length mm	Shank dia. mm	Sales Pkg Qty	Part No.
★★★★☆	13	151	101	13	1	D-64244
					5	D-64490
★★★★☆	14	160	108	13	1	D-65741
	15	169	114	13	1	D-65757
	16	178	120	13	1	D-65763
	17	184	125	13	1	D-65779
	18	191	130	13	1	D-65785
	19	198	135	13	1	D-65791
	20	205	140	13	1	D-65800

Metal drill bit HSS-TiN assortment in plastic case



Range	Diameter mm	Sales Pkg Qty	Part No.
★★★★☆	1 to 10	19	B-67795
★★★★☆	2 to 8	6	D-72833
	1 to 10	10	D-72849
	1.5 to 6.5	13	D-72855
	1 to 10	19	D-67527
	1 to 10	19x10sets	D-72229-10
	1 to 13	25x6sets	D-72235-6

Metal drill bit HSS-TiN coated flute assortment in plastic case



Range	Diameter mm	Sales Pkg Qty	Part No.
★★★★☆	2, 3, 4, 5, 6, 8,	6	D-77241

Metal drill bit HSS-TiN coated flute assortment in metal case



Range	Diameter mm	Sales Pkg Qty	Part No.
★★★★☆	1 to 10	170	D-30564

Metal drill bit HSS-TiN with 1/4inch Hex shank



Range	Diameter mm	Length mm	Working Length mm	Shank Type	Sales Pkg Qty	Part No.
★★★★☆	2.5	78	30	1/4inch Hex MZ	1	D-46517
	3	81	33		1	D-14928
	3.2	85	36		1	D-14934
	3.3	85	36		1	D-16081
	4	95	43		1	D-14940
	4.1	95	43		1	D-16483
	4.2	95	43		1	D-14956
	5	106	52		1	D-14962
	5.2	102	52		1	D-46523
	6	113	57		1	D-14978
	6.5	121	63		1	D-17778
	8	117	75		1	D-15827
	10	133	87		1	D-15833
	12	151	101		1	D-15849
	13	151	101		1	D-15855
	2.5	78	30		1	D-46539
	3	91	33		1	D-31114
	3.2	95	36		1	D-31120
	3.3	95	36		1	D-31136
4	105	43	1	D-31142		
4.1	105	43	1	D-31158		
4.2	105	43	1	D-31164		
5	116	52	1	D-31170		
5.2	102	52	1	D-46545		
6	123	57	1	D-31186		
6.5	131	63	1	D-31192		
8	117	75	1	D-31201		
10	133	87	1	D-31217		
12	151	101	1	D-31223		
13	151	101	1	D-31239		

Metal impact drill bit HSS-TiN with 1/4inch Hex shank



Range	Diameter mm	Length mm	Working Length mm	Shank Type	Sales Pkg Qty	Part No.
★★★★☆	3	64	26	1/4inch Hex MZ	1	B-50887
	3.2	67	29		1	B-50893
	3.3	70	29		1	B-50902
	3.5	70	29		1	B-50918
	4	71	30		1	B-50924
	4.2	71	31		1	B-50930
	4.5	75	31		1	B-50946
	5	78	33		1	B-50952
	5.5	78	35		1	B-50968
	6	80	37		1	B-50974
	6.5	81	38		1	B-50980
	7	89	45		1	B-50996
	7.5	95	50		1	B-51007
	8	102	50		1	B-51013
	8.5	102	50		1	B-51029
	9	102	50		1	B-51035
	10	102	50		1	B-51041
	11	102	50		1	B-51057
	12	102	50		1	B-51063
	13	102	50		1	B-51079

Range	Diameter mm	Length mm	Working Length mm	Shank Type	Sales Pkg Qty	Part No.
★★★★☆	3	64	26	1/4inch Hex NZ	1	B-51085
	3.2	67	29		1	B-51091
	3.3	70	29		1	B-51100
	3.5	70	29		1	B-51116
	4	71	30		1	B-51122
	4.2	71	31		1	B-51138
	4.5	75	31		1	B-51144
	5	78	33		1	B-51150
	5.5	78	35		1	B-51166
	6	80	37		1	B-51172
	6.5	81	38		1	B-51188
	7	89	45		1	B-51194
	7.5	95	50		1	B-51203
	8	102	50		1	B-51219
	8.5	102	50		1	B-51225
9	102	50	1	B-51231		
10	102	50	1	B-51247		
11	102	50	1	B-51253		
12	102	50	1	B-51269		
13	102	50	1	B-51275		

Metal impact drill bit HSS-TiN with 1/4inch Hex shank assortment



Range	Diameter mm	Shank Type	Sales Pkg Qty	Part No.
★★★★☆	3, 4, 5, 6, 8	1/4inch Hex MZ	5	B-57308

Metal drill bit HSS-TiN for SDS-PLUS Hammers



Range	Diameter mm	Length mm	Working Length mm	Shank Type	Sales Pkg Qty	Part No.
★★★★☆	3	90	33	SDS-PLUS	1	B-57401
	3.5	100	39		1	B-57417
	4	105	43		1	B-57423
	4.5	110	47		1	B-57439
	5	116	52		1	B-57445
	5.5	123	57		1	B-57451
	6	123	57		1	B-57467
	6.5	131	63		1	B-57473

Metal drill bit HSS-TiN for SDS-PLUS Hammers assortment in plastic case

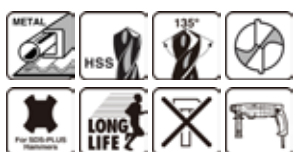

Range	Diameter mm	Shank Type	Sales Pkg Qty	Part No.
★★★★☆	3, 3.5, 4, 5, 6	SDS-PLUS	12	E-15132-12

Metal drill bit HSS-G



Range	Diameter mm	Length mm	Working Length mm	Sales Pkg Qty	Part No.
★★★★☆	1.5	40	18	1	D-09656
				10	D-06236
	1.75	46	22	10	D-06242
				1	D-09662
	2	49	24	10	D-06258
				10	D-06264
	2.25	53	27	10	D-06264
				1	D-09678
	2.5	57	30	10	D-06270
				10	D-06286
	2.75	61	33	10	D-06286
				1	D-46816
	2.9	61	33	10	D-46648
				1	D-09684
	3	61	33	10	D-06292
				1	D-46589
	3.2	65	36	10	D-34942
				10	D-06301
	3.25	65	36	10	D-46595
				1	D-46567
	3.3	65	36	10	D-46567
				1	D-09690
	3.5	70	39	10	D-06317
				10	D-06323
	3.75	70	39	10	D-06323
				1	D-09709
	4	75	43	10	D-06339
				1	D-46604
	4.2	75	43	10	D-17762
				10	D-06345
	4.25	75	43	10	D-06345
				1	D-09715
	4.5	80	47	10	D-06351
				10	D-06367
	4.75	80	47	10	D-06367
				1	D-09721
	5	86	52	10	D-06373
				1	D-46610
	5.2	86	52	10	D-34986
				10	D-06389
	5.25	86	52	10	D-06389
				1	D-46822
	5.3	86	52	10	D-46654
				1	D-09737
	5.5	93	57	10	D-06395
10				D-06404	
5.75	93	57	10	D-06404	
			1	D-09743	
6	93	57	10	D-06410	
			10	D-06426	
6.25	101	63	10	D-06426	
			1	D-09759	
6.5	101	63	10	D-06432	
			10	D-06448	
6.75	109	69	10	D-06448	
			1	D-46838	
6.8	109	69	10	D-46779	
			1	D-09765	
7	109	69	10	D-06454	
			10	D-06460	
7.25	109	69	10	D-06460	
			1	D-09771	
7.5	109	69	10	D-06476	
			10	D-06482	
7.75	117	75	10	D-06482	
			1	D-09787	
8	117	75	10	D-06498	
			10	D-06507	
8.25	117	75	5	D-06507	
			1	D-09793	
8.5	117	75	5	D-06513	
			5	D-06529	
8.75	125	81	5	D-06529	
			1	D-46844	
8.8	125	81	5	D-46785	
			1	D-09802	
9	125	81	5	D-06535	
			5	D-06541	
9.25	125	81	5	D-06541	
			1	D-09818	
9.5	125	81	5	D-06557	
			5	D-06563	
9.75	133	87	5	D-06563	
			1	D-09824	
10	133	87	5	D-06579	
			5	D-06579	

Range	Diameter mm	Length mm	Working Length mm	Sales Pkg Qty	Part No.
★★★★☆	10.25	133	87	5	D-06585
	10.3	133	87	1	D-46850
	10.3	133	87	5	D-46791
	10.5	133	87	1	D-09830
	10.5	133	87	5	D-06591
	10.8	142	94	1	D-46866
	10.8	142	94	5	D-46800
	11	142	94	1	D-09846
	11	142	94	5	D-06600
	11.5	142	94	1	D-09852
	11.5	142	94	5	D-06616
	12	151	101	1	D-09868
	12	151	101	5	D-06622
	12.5	151	101	1	D-09874
	12.5	151	101	5	D-06638
	13	151	101	1	D-09880
	13	151	101	5	D-06644
	14	160	108	1	D-74893
	15	169	114	1	D-74902
16	178	120	1	D-74918	

Metal drill bit HSS-G assortment in plastic case



Range	Diameter mm	Sales Pkg Qty	Part No.
★★★★☆	2 to 8	6	D-75742
	1 to 10	19	D-67549
	1 to 13	25	D-67555

Metal drill bit HSS-G assortment in metal case



Range	Diameter mm	Sales Pkg Qty	Part No.
★★★★☆	1.5 to 6.5	13	D-54019
	1 to 10	19	D-54025
	1 to 13	25	D-54031

Metal drill bit HSS M-Force



Range	Diameter mm	Length mm	Working Length mm	Sales Pkg Qty	Part No.
★★★★☆	2	49	24	1	D-29614
	2.5	57	30	1	D-29620
	3	61	33	1	D-29636
	3.2	65	36	1	D-37633
	3.3	65	36	1	D-46626
	3.5	70	39	1	D-29642
	4	75	43	1	D-29658
	4.2	75	43	1	D-37649
	4.5	80	47	1	D-29664
	5	86	52	1	D-29670
	5.2	86	52	1	D-37655
	5.5	93	57	1	D-29686
	6	93	57	1	D-29692
	6.5	101	63	1	D-29701
	7	109	69	1	D-29717
	7.5	109	69	1	D-29723
	8	117	75	1	D-29739
	8.5	117	75	1	D-29745
	9	125	81	1	D-29751
	9.5	125	81	1	D-29767
	10	133	87	1	D-29773
	10.5	133	87	1	D-29789
	11	142	94	1	D-29795
11.5	142	94	1	D-29804	
12	151	101	1	D-29810	
12.5	151	101	1	D-29826	
13	151	101	1	D-29832	

Metal drill bit HSS M-Force assortment in plastic case



Range	Diameter mm	Sales Pkg Qty	Part No.
★★★★☆	1 to 10	19	D-67583
★★★★☆	1 to 13	25	D-67599
★★★★☆	4, 5, 6, 8, 10	5	D-30508

Metal drill bit HSS-Co cobalt 5%



Range	Diameter mm	Length mm	Working Length mm	Sales Pkg Qty	Part No.
Specialized	1.5	40	18	1	D-17289
	1.75	46	22	5	D-16617
				5	D-17625
	2	49	24	1	D-17295
				5	D-16623
	2.5	57	30	1	D-17304
				5	D-16639
	3	61	33	1	D-17310
				5	D-16645
	3.2	65	36	1	D-17326
				5	D-16651
	3.3	65	36	1	D-46660
				5	D-46632
	3.5	70	39	1	D-17332
				5	D-16667
	4	75	43	1	D-17348
				5	D-16673
	4.2	75	43	1	D-46676
				5	D-34958
	4.5	80	47	1	D-17354
				5	D-16689
	5	86	52	1	D-17360
				5	D-16695
	5.2	86	52	1	D-46682
				5	D-34992
	5.5	93	57	1	D-17376
				5	D-16704
	6	93	57	1	D-17382
				5	D-16710
	6.5	101	63	1	D-17398
5				D-16726	
7	109	69	1	D-17407	
			5	D-16732	
7.5	109	69	1	D-17413	
			5	D-16748	
8	117	75	1	D-17429	
			5	D-16754	
8.5	117	75	1	D-17435	
			5	D-16760	
9	125	81	1	D-17441	
			5	D-16776	
9.5	125	81	1	D-17457	
			5	D-16782	
10	133	87	1	D-17463	
			5	D-16798	
10.5	133	87	1	D-17479	
			5	D-16807	
11	142	94	1	D-17485	
			5	D-16813	
11.5	142	94	1	D-17491	
			5	D-16829	
12	151	101	1	D-17500	
			5	D-16835	
12.5	151	101	1	D-17516	
			5	D-16841	
13	151	101	1	D-17522	
			5	D-16857	

Metal drill bit HSS-Co cobalt 5% assortment in plastic case



Range	Diameter mm	Sales Pkg Qty	Part No.
Specialized	2 to 8	6	D-75758
	1 to 10	19	D-67561
	1 to 13	25	D-67577

Metal rivet drill bit with 1/4inch Hex shank



Range	Diameter mm	Length mm	Working Length mm	Shank Type	Sales Pkg Qty	Part No.
★★★★☆	3.3	50	20	1/4inch Hex MZ	10	B-56437

Metal double ended drill bit



Range	Diameter mm	Length mm	Working Length mm	Sales Pkg Qty	Part No.
★★★★☆	2	38	7.5	10	B-26652
	2.5	43	10	10	B-33772
	3	46	10.6	10	B-26668
	3.1	49	11	10	B-26674
	3.2	49	11	10	B-26680
	3.3	49	11	10	B-26696
	3.5	52	13	10	B-26705
	3.8	55	14	10	B-26711
	4	55	14	10	B-26727
	4.1	55	14	10	B-26733
	4.2	55	14	10	B-26749
	4.3	55	14	10	B-26755
	4.5	58	16	10	B-26761
	4.8	62	17	10	B-26777
	4.9	62	17	10	B-26783
	5	62	17	10	B-26799
	5.1	62	17	10	B-26808
	5.2	62	17	10	B-26814
	5.5	66	19	10	B-26820
	6	66	19	10	B-26836
	6.5	70	21	10	B-33788
	8	79	25	10	B-26842
	10	89	25	10	B-26858

Step drill bit

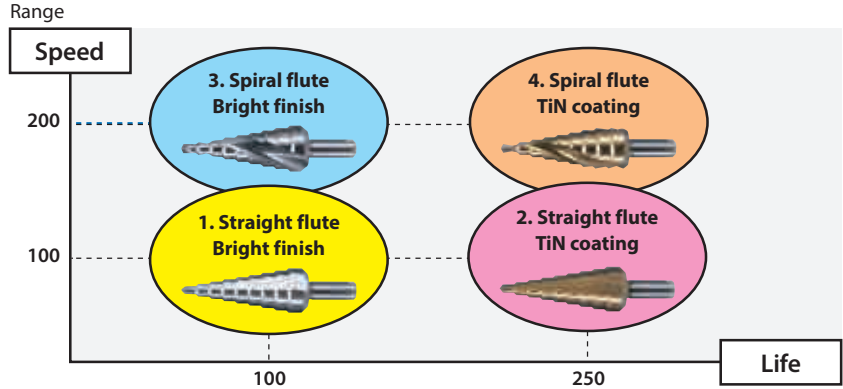
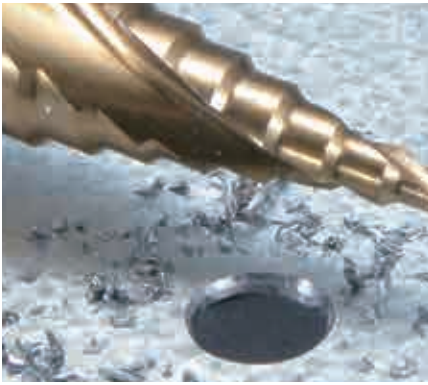

Material chart

AA : Recommended A : Acceptable

Description	Flute	Surface	Shank	Material				
				Plastic	Non-ferrous metal*	Sheet steel	Alloy steel	Cast iron
1	Straight	Bright finish	Straight (Three flat) 1/4"Hex (E form)	AA	AA	AA	A	A
2	Straight	Titanium coating		AA	AA	AA	A	A
3	Spiral	Bright finish		AA	AA	AA	A	A
4	Spiral	Titanium coating		AA	AA	AA	A	A

*Non-ferrous metal (Such as Copper, Nickel and Zinc)

Countersink bit



Material chart

AA : Recommended A : Acceptable

Description	Made of	Type	Shank	Material					
				Wood	Plastic	Non-ferrous metal*	Cast iron	Alloy steel	Stainless steel
7cutting edge	Alloy steel	Shallow sinking Suitable for flat countersinking.	1/4"Hex (E form)	AA	AA	AA	AA		
5cutting edge	High speed steel		Straight shank (Three flat)	AA	AA	AA	AA	AA	
3cutting edge		Deep sinking Suitable for deep countersinking.	1/4"Hex (C-form)	AA	AA	AA	AA	AA	
3cutting edge	Straight shank (Three flat)		AA	AA	AA	AA	AA		
Slanting hole It's for higher heat and abrasion resistance. Suitable for drilling tough metal.	High speed steel (HSS-Co) (Cobalt content 5%)	Shallow sinking Suitable for flat countersinking. Especially in thin metal sheets.	Straight shank (Three flat)		AA	AA	AA	AA	A

*Non-ferrous metal (Such as Copper, Nickel and Zinc)

Metal cone drill bit

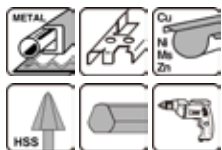

Range	Diameter mm	Length mm	Shank Type	Sales Pkg Qty	Part No.
★★★☆☆	3 ~ 14	58	Straight	1	D-40048
	4 ~ 20	71	Straight	1	D-40054
	16 ~ 30.5	76	Straight	1	D-40060
	24 ~ 40	89	Straight	1	D-40076

Metal step drill bit straight flute



Range	Diameter mm	Length mm	Shank Type	Sales Pkg Qty	Part No.
★★★☆☆	4 ~ 32	102	Straight	1	D-40107

Metal step drill bit straight flute titanium coating



Range	Diameter mm	Length mm	Shank Type	Sales Pkg Qty	Part No.
★★★☆☆	4 ~ 32	102	Straight	1	D-40135

Metal step drill bit with 1/4inch Hex shank straight flute

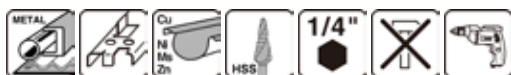

Range	Diameter mm	Length mm	Shank Type	Sales Pkg Qty	Part No.
★★★☆☆	4 ~ 12	65	1/4inch	1	D-40082
	4 ~ 20	75	Hex MZ	1	D-40098
	4 ~ 12	65	1/4inch	1	D-46414
	4 ~ 20	75	Hex NZ	1	D-46420

Metal step drill bit with 1/4inch Hex shank straight flute titanium coating



Range	Diameter mm	Length mm	Shank Type	Sales Pkg Qty	Part No.
★★★☆☆	4 ~ 12	65	1/4inch	1	D-40113
	4 ~ 20	75	Hex MZ	1	D-40129
	4 ~ 12	65	1/4inch	1	D-46436
	4 ~ 20	75	Hex NZ	1	D-46442

Metal step drill bit straight flute titanium coating assortment in plastic case

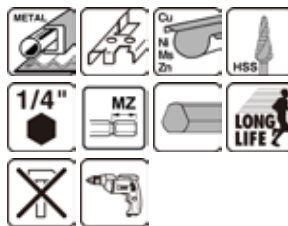

Range	Diameter mm	Length mm	Shank Type	Sales Pkg Qty	Part No.
★★★★☆	4 to 12, 4 to 20, 4 to 32	65-102	1/4inch Hex MZ, Straight	3	D-46573

Metal step drill bit spiral flute



Range	Diameter mm	Length mm	Shank Type	Sales Pkg Qty	Part No.
★★★★☆	4 ~ 32	102	Straight	1	D-40163

Metal step drill bit spiral flute titanium coating



Range	Diameter mm	Length mm	Shank Type	Sales Pkg Qty	Part No.
★★★★☆	4 ~ 32	102	Straight	1	D-40191

Metal step drill bit with 1/4inch Hex shank spiral flute



Range	Diameter mm	Length mm	Shank Type	Sales Pkg Qty	Part No.
★★★★☆	4 ~ 12	65	1/4inch	1	D-40141
	4 ~ 20	75	Hex MZ	1	D-40157
	4 ~ 12	65	1/4inch	1	D-46458
	4 ~ 20	75	Hex NZ	1	D-46464

Metal step drill bit with 1/4inch Hex shank spiral flute titanium coating



Range	Diameter mm	Length mm	Shank Type	Sales Pkg Qty	Part No.
★★★★☆	4 ~ 12	65	1/4inch	1	D-40179
	4 ~ 20	75	Hex MZ	1	D-40185
	4 ~ 12	65	1/4inch	1	D-46470
	4 ~ 20	75	Hex NZ	1	D-46486

Metal step drill bit spiral flute titanium coating assortment in plastic case

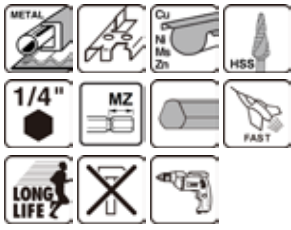

Range	Diameter mm	Length mm	Shank Type	Sales Pkg Qty	Part No.
★★★★☆	4 to 12, 4 to 20, 4 to 32	65-102	1/4inch Hex MZ, Straight	3	D-41872

Countersink bit with 1/4inch Hex shank three cutting edges 90deg



Range	Diameter mm	Length mm	Shank Type	Sales Pkg Qty	Part No.
★★★★☆	6.3	31	1/4inch Hex C-form	1	D-37312
	8.3	31		1	D-37328
	10.4	34		1	D-37334
	12.4	35		1	D-37340
	16.5	40		1	D-37356
	20.5	41		1	D-37362

Metal countersink bit slanting hole



Range	Diameter mm	Length mm	Shank Type	Sales Pkg Qty	Part No.
★★★★☆	2 ~ 5	45	Straight	1	D-37502
	5 ~ 10	48		1	D-37518
	10 ~ 15	65		1	D-37524
	15 ~ 20	85		1	D-37530

Countersink bit five cutting edges 90deg



Range	Diameter mm	Length mm	Shank Type	Sales Pkg Qty	Part No.
★★★★☆	6	48	Straight	1	D-37378
	8	48		1	D-37384
	10	40		1	D-37390
	12	40		1	D-37409
	16	43		1	D-37415
	20	45		1	D-37421

Countersink bit three cutting edges 90deg



Range	Diameter mm	Length mm	Shank Type	Sales Pkg Qty	Part No.
★★★★☆	6.3	45	Straight	1	D-37437
	8.3	50		1	D-37443
	10.4	50		1	D-37459
	12.4	56		1	D-37465
	16.5	60		1	D-37471
	20.5	63		1	D-37487
	25	67		1	D-37493

Countersink bit seven cutting edges 90deg



Range	Diameter mm	Length mm	Shank Type	Sales Pkg Qty	Part No.
★★★★☆	13	50	Straight	1	D-37306

Wood countersink drill bit with 1/4inch Hex shank assortment



Range	Diameter (inch)	Length (inch)	Shank Type	Sales Pkg Qty	Part No.
★★★★☆	(3/32-6, 7/64-8, 1/8-10, 9/64-12)	(2-1/4, 2-13/32, 2-9/16, 2-3/4)	1/4inch Hex MZ	4	D-73455

Countersink bit three cutting edges 90deg assortment in metal case



Range	Diameter mm	Length mm	Shank Type	Sales Pkg Qty	Part No.
★★★★☆	6.3, 8.3, 10.4, 12.4, 16.5, 20.5	45, 50, 50, 56, 60, 63	Straight	6	D-42204

Wood drill bit series





AA : Recommended A : Acceptable

Category		Flat bit		Brad point drill bit			Single spur auger bit			Ship auger bit	
											
Description		Suitable for drilling holes with medium to large diameters in soft wood or soft plastic.It's simple made and reasonable price.It's popular especially in America.	Fast drilling bit with making-off blades and rake blades	This is the most popular drill in wood drill and suitable for drilling holes with small to medium diameter.Able to drill soft plastics other than general wood.Highly effective for drilling cleaner and more precise holes than flat bit.			Suitable for drilling of deep holes with medium to large diameters holes in soft and hard wood.Threaded screw point pull the bit into the work piece providing a fast, easy to use self feeding action. Highly effective for drilling cleaner and more precise holes than flat bit or wood drill bit.			Features of this item are fast drilling speed and good work amount per 1 charge.	Suitable for knotty nail embedded wood which unable to drill with single spur auger bit. Suitable for plumbing and electrical installation, etc.
Information	Shank										
	Diameter	6 - 36mm		3 - 20mm	2 - 15mm	4 - 10mm	6 - 30mm	6-21mm	6 - 30mm	10-38mm	
	Point	Brad point 		Brad point 			Auger thread 			Auger thread 	Auger thread 
Material	Wood 	AA		AA			AA			A	
	Wood with nail 									AA	
	Plywood 			A			A			A	
Processing	Thickness 										
	Blind hole 			A							
Action photo											

Wood drill bit series

AA : Recommended A : Acceptable



Category		Formwork drill bit	Self feeding bit	Forstner drill bit	T.C.T. Hinge cutting bit	Adjustable circle cutter
		Description		Rarely being clogged even drilling on plywood including adhesive because of chisel edge. Can be used on formboard or 2x4 timbers at once because of their long overall length (400 & 600mm)	Suitable for drilling large diameter holes for pipe and conduit in wood. Threaded screw point pull the bit into the work piece providing a fast, easy to use self feeding action. Suitable for plumbing and electrical installation, etc	Suitable for drilling of blind holes or penetrating holes of medium to large diameter with highly. Can drill cleaner and more precise holes than T.C.T. Hinge drill bit. Suitable for precise working like a making furniture.
Information	Shank	Straight (Cylindrical) 	7/16"Hex 	Straight (Cylindrical) 	Straight (Cylindrical) 	Straight (Three flat) 
	Diameter	8-30mm	25-117mm	10-50mm	15-35mm	30-200mm
	Point	Chisel edge 	Auger thread 	Brad point (Short) 	Brad point (Short) 	Chisel edge 
Material	Wood 	A	AA	AA	AA	A
	Wood with nail 	A				
	Plywood 	AA			A	A
Processing	Thickness 					
	Blind hole 			AA	AA	
Action photo						

Wood brad point drill bit



Range	Diameter mm	Length mm	Working Length mm	Sales Pkg Qty	Part No.
★★★★☆	3	61	33	1	D-07026
				10	D-71722
	4	75	43	1	D-07032
				10	D-71738
	5	86	52	1	D-07048
				10	D-71744
	6	93	57	1	D-07054
				10	D-71750
	6	315	150	1	D-07157
	7	109	69	1	D-07060
	8	117	75	1	D-07076
				10	D-71766
	8	315	150	1	D-07163
	9	125	80	1	D-07082
	10	133	87	1	D-07098
				5	D-71772
	10	315	150	1	D-07179
	12	151	96	1	D-07107
	12	315	150	1	D-07185
	13	151	96	1	D-53453
14	160	100	1	D-07113	
14	315	150	1	D-07191	
15	160	100	1	D-53469	
16	160	100	1	D-07129	
16	315	150	1	D-07200	
18	180	120	1	D-07135	
18	335	150	1	D-07216	
20	200	130	1	D-07141	
20	335	150	1	D-07222	

Wood brad point drill bit assortment in plastic case



Range	Diameter mm	Sales Pkg Qty	Part No.
★★★★☆	4 to 10	5	D-72861

Wood brad point drill bit with 1/4inch Hex shank



Range	Diameter mm	Length mm	Working Length mm	Shank Type	Sales Pkg Qty	Part No.
★★★★☆	2	69	24	1/4inch Hex MZ	1	D-62387
	3	78	33		1	D-15861
	4	92	50		1	D-15877
	5	103	57		1	D-15883
	6	110	65		1	D-15899
	8	117	75		1	D-15908
	10	133	87		1	D-15914
	12	151	96		1	D-15920
	15	162	100		1	D-15936

Range	Diameter mm	Length mm	Working Length mm	Shank Type	Sales Pkg Qty	Part No.
★★★★☆	3	80	33	1/4inch Hex NZ	1	D-31245
	4	95	43		1	D-31251
	5	105	52		1	D-31267
	6	115	57		1	D-31273
	8	117	75		1	D-31289
	10	133	87		1	D-31295
	12	151	96		1	D-31304
	15	162	100		1	D-31310

Wood brad point drill bit with 1/4inch Hex shank assortment



Range	Diameter mm	Shank Type	Sales Pkg Qty	Part No.
★★★★☆	2, 3, 3, 4, 5, 6, 8	1/4inch Hex MZ	7	D-62371

Wood brad point drill bit for SDS-PLUS Hammers



Range	Diameter mm	Length mm	Working Length mm	Shank Type	Sales Pkg Qty	Part No.
★★★★☆	4	105	43	SDS-PLUS	1	B-57489
	5	116	52		1	B-57495
	6	123	57		1	B-57504
	8	147	75		1	B-57510
	10	163	87		1	B-57526

Wood brad point drill bit for SDS-PLUS Hammers assortment in plastic case



Range	Diameter mm	Shank Type	Sales Pkg Qty	Part No.
★★★★☆	4, 5, 6, 8, 10	SDS-PLUS	12	E-15148-12

Wood flat bit



Range	Diameter mm	Length mm	Sales Pkg Qty	Part No.
★★★★☆	6	150	1	D-07674
	8	150	1	D-07680
	10	150	1	D-07696
	12	150	1	D-07705
	13	150	1	D-67614

Range	Diameter mm	Length mm	Sales Pkg Qty	Part No.
★★★★☆	14	150	1	D-07711
	15	150	1	D-07727
	16	150	1	D-07733
	18	150	1	D-07749
	20	150	1	D-07755
	22	150	1	D-07761
	24	150	1	D-07777
	25	150	1	D-07783
	26	160	1	D-07799
	28	160	1	D-07808
	30	160	1	D-07814
	32	160	1	D-07820
	34	160	1	D-07836
	35	160	1	D-07842
36	160	1	D-07858	

Wood flat bit with 1/4inch Hex shank



Range	Diameter mm	Length mm	Shank Type	Sales Pkg Qty	Part No.
★★★★☆	6	150	1/4inch Hex MZ	1	E-17164
	6	400		1	E-17376
	8	150		1	E-17170
	8	400		1	E-17382
	10	150		1	E-17186
	10	400		1	E-17398
	12	150		1	E-17192
	12	400		1	E-17407
	13	150		1	E-17201
	13	400		1	E-17413
	14	150		1	E-17217
	14	400		1	E-17429
	16	150		1	E-17223
	16	400		1	E-17435
	18	150		1	E-17239
	18	400		1	E-17441
	19	150		1	E-17245
	19	400		1	E-17457
	20	150		1	E-17251
	20	400		1	E-17463
	22	150		1	E-17267
	22	400		1	E-17479
	24	150		1	E-17273
	24	400		1	E-17485
	25	150		1	E-17289
	25	400		1	E-17491
	26	150		1	E-17295
	26	400		1	E-17500
	28	150		1	E-17304
	28	400		1	E-17516
	30	150		1	E-17310
	30	400		1	E-17522
	32	150		1	E-17326
	32	400		1	E-17538
	35	150		1	E-17332
	35	400		1	E-17544
	36	150		1	E-17348
	38	150		1	E-17354
	40	150		1	E-17360

Wood flat bit with 1/4inch Hex shank assortment in clear case series

Clear case



Range	Diameter mm	Shank Type	Sales Pkg Qty	Part No.
★★★★☆	12 to 32	1/4inch	8	E-08698
	12 to 32	Hex MZ	8x10sets	E-08698-10
	12 to 32	1/4inch	8	E-08707
	12 to 32	Hex NZ	8x10sets	E-08707-10

Wood flat bit with 1/4inch Hex shank extension bar



Range	Length mm(inch)	Shank Type	Sales Pkg Qty	Part No.
★★★★☆	300(12)	Straight	1	D-77213

Wood single spur auger bit with Hex shank



Range	Diameter mm	Length mm	Working Length mm	Sales Pkg Qty	Part No.
★★★★☆	6	200	130	1	D-07238
	6	250	180	1	D-07331
	8	200	130	1	D-07244
	8	250	180	1	D-07347
	8	400	330	1	D-07434
	8	450	380	1	D-07559
	10	200	130	1	D-07250
	10	250	180	1	D-07353
	10	400	330	1	D-07440
	10	450	380	1	D-07565
	12	200	130	1	D-07266
	12	250	180	1	D-07369
	12	400	330	1	D-07456
	12	450	380	1	D-07571
	13	250	180	1	D-53475
	13	450	380	1	D-53497
	14	200	130	1	D-07272
	14	250	180	1	D-07375
	14	400	330	1	D-07462
	14	450	380	1	D-07587
	15	250	180	1	D-53481
	15	450	380	1	D-53506
	16	200	130	1	D-07288
	16	250	180	1	D-07381
	16	400	330	1	D-07478
	16	450	380	1	D-07593
	18	200	130	1	D-07294
	18	250	180	1	D-07397
	18	400	330	1	D-07484
	18	450	380	1	D-07602
	20	200	130	1	D-07303

Range	Diameter mm	Length mm	Working Length mm	Sales Pkg Qty	Part No.
★★★★☆	20	250	180	1	D-07406
	20	400	330	1	D-07490
	20	450	380	1	D-07618
	22	200	130	1	D-07319
	22	250	180	1	D-07412
	22	400	330	1	D-07509
	22	450	380	1	D-07624
	24	200	130	1	D-07325
	24	250	180	1	D-07428
	24	400	330	1	D-07515
	24	450	380	1	D-07630
	26	400	330	1	D-07521
	26	450	380	1	D-07646
	28	400	330	1	D-07537
	28	450	380	1	D-07652
	30	400	330	1	D-07543
	30	450	380	1	D-07668

Wood single spur auger bit with Hex shank 3D long



Range	Diameter mm	Length mm	Working Length mm	Sales Pkg Qty	Part No.
★★★★☆	6	400	325	1	E-07755
	8	400	325	1	E-07761
	9	400	325	1	E-07777
	10	400	325	1	E-07783
	10.5	400	325	1	E-07799
	10.5	500	425	1	E-07923
	11	400	325	1	E-07808
	12	400	325	1	E-07814
	12	500	425	1	E-07939
	13	400	325	1	E-07820
	13.5	400	325	1	E-07836
	13.5	500	425	1	E-07945
	15	400	325	1	E-07842
	15	500	425	1	E-07951
	16	400	325	1	E-07858
	18	400	325	1	E-07864
	18	500	425	1	E-07967
	21	400	325	1	E-07870
	21	500	425	1	E-07973
	22	400	325	1	E-07886
	24	400	325	1	E-07892
	24	500	425	1	E-07989
	27	400	325	1	E-07901
	27	500	425	1	E-07995
	30	400	325	1	E-07917
	30	500	425	1	E-08006

Wood single spur auger bit with 1/4inch Hex shank



Range	Diameter mm	Length mm	Working Length mm	Shank Type	Sales Pkg Qty	Part No.
★★★★☆	6	200	130	1/4inch Hex MZ	1	D-15992
	8	200	130		1	D-16003
	10	200	130		1	D-16019
	12	200	130		1	D-16025
	13	200	130		1	D-76059
	14	200	130		1	D-16031
	16	200	130		1	D-16047
	18	200	130		1	D-16053
	19	200	130		1	D-76065

Range	Diameter mm	Length mm	Working Length mm	Shank Type	Sales Pkg Qty	Part No.
★★★★☆	20	200	130	1/4inch Hex NZ	1	D-16069
	21	200	130		1	D-16075
	6	200	130		1	D-31326
	8	200	130		1	D-31332
	10	200	130		1	D-31348
	12	200	130		1	D-31354
	14	200	130		1	D-31360
	16	200	130		1	D-31376
	18	200	130		1	D-31382
	20	200	130		1	D-31398
	21	200	130		1	D-31407

Wood single spur auger bit with 1/4inch Hex shank assortment



Range	Diameter mm	Length mm	Working Length mm	Shank Type	Sales Pkg Qty	Part No.
★★★★☆	6, 8, 13, 16, 19	200	130	1/4inch Hex MZ	5	D-75677

Wood ship auger bit with 7/16inch Hex shank



Range	Diameter mm	Length mm	Working Length mm	Shank Type	Sales Pkg Qty	Part No.
★★★★☆	10	165	100	5/16inch Hex	1	D-36055
	12	165	100		1	D-36061
	10	470	395		1	D-36192
	12	470	395		1	D-36201
	14	165	100		1	D-36077
	14	470	395		1	D-36217
	16	60	100		1	D-36083
	16	470	395		1	D-36223
	18	165	100		1	D-36099
	18	470	395		1	D-36239
	20	165	100		1	D-36108
	20	470	395		1	D-36245
	22	165	100	1	D-36114	
	22	470	395	1	D-36251	
	24	165	100	1	7/16inch Hex	D-36120
	24	470	395	1		D-36267
	26	165	100	1		D-36136
	26	470	395	1		D-36273
	28	165	100	1		D-36142
	28	470	395	1		D-36289
	30	165	100	1		D-36158
	30	470	395	1		D-36295
	32	165	100	1		D-36164
	32	470	395	1		D-36304
	35	165	100	1		D-36170
	35	470	395	1		D-36310
	38	165	100	1	D-36186	
	38	470	395	1	D-36326	

Wood formwork drill bit



Range	Diameter mm	Length mm	Working Length mm	Sales Pkg Qty	Part No.
★★★★☆	8	400	75	1	D-70219
	8	600	75	1	D-70334
	10	400	87	1	D-70225
	10	600	87	1	D-70340
	12	400	101	1	D-70231
	12	600	101	1	D-70356
	14	400	108	1	D-70247
	14	600	108	1	D-70362
	16	400	100	1	D-70253
	16	600	100	1	D-70378
	18	400	100	1	D-70269
	18	600	100	1	D-70384
	20	400	100	1	D-70275
	20	600	100	1	D-70390
	22	400	100	1	D-70281
	22	600	100	1	D-70409
	24	400	100	1	D-70297
	24	600	100	1	D-70415
	26	400	100	1	D-70306
	26	600	100	1	D-70421
	28	400	100	1	D-70312
	28	600	100	1	D-70437
	30	400	100	1	D-70328
	30	600	100	1	D-70443

Wood self feeding bit with 7/16inch Hex shank



Range	Diameter mm	Length mm	Shank Type	Sales Pkg Qty	Part No.
★★★★☆	25	127	7/16inch Hex	1	D-74304
	28	127		1	D-74310
	32	127		1	D-74326
	35	127		1	D-74332
	38	127		1	D-74348
	45	127		1	D-74354
	51	127		1	D-74360
	54	127		1	D-74376
	57	127		1	D-74382
	65	127		1	D-74398
	76	127		1	D-74407
	92	127		1	D-74413
	117	127		1	D-74429

Wood self feeding bit with 7/16inch Hex shank assortment in plastic case



Range	Diameter (inch)	Shank Type	Sales Pkg Qty	Part No.
★★★★☆	(1 to 3)	7/16inch Hex	7	D-36005

Wood self feeding bit with 7/16inch Hex shank extension bar



Range	Length mm	Shank Type	Sales Pkg Qty	Part No.
★★★★☆	140	7/16inch Hex	1	D-74457
	305		1	D-74463
	457		1	D-74479

Wood self feeding bit with 7/16inch Hex shank spare part



Range	Diameter mm	Sales Pkg Qty	Part No.
★★★★☆	For 25 ~ 65	1	D-74435
	For 76 ~ 117	1	D-74441

Wood forstner bit



Range	Diameter mm	Length mm	Sales Pkg Qty	Part No.
★★★★☆	10	90	1	D-41844
	15	90	1	D-41925
	20	90	1	D-42232
	25	90	1	D-42248
	26	90	1	D-42254
	30	90	1	D-42260
	32	90	1	D-42276
	35	90	1	D-42282
	40	90	1	D-42298
	50	90	1	D-42307

Wood forstner bit assortment in MDF case



Range	Diameter mm	Sales Pkg Qty	Part No.
★★★★☆	15, 20, 25, 30, 35	5	D-47363

Wood TCT hinge cutting bit



Range	Diameter mm	Length mm	Sales Pkg Qty	Part No.
★★★★☆	15	77	1	D-71093
	16	77	1	D-74681
	18	77	1	D-74697
	19	77	1	D-71102
	20	77	1	D-71118
	22	77	1	D-74706
	23	77	1	D-74712
	25	77	1	D-71124
	26	77	1	D-71130
	30	77	1	D-71146
32	77	1	D-71152	
35	77	1	D-71168	

Wood shiitake drill bit



Range	Diameter mm	Length mm	Working Length mm	Sales Pkg Qty	Part No.
Specialized	12	76	45	1	B-49753

Masonry TCT drill bit with 1/4inch Hex shank



Range	Diameter mm	Length mm	Working Length mm	Shank Type	Sales Pkg Qty	Part No.
★★★★☆	3	80	35	1/4inch Hex MZ	1	D-23771
	4	80	35		1	D-23787
	5	90	45		1	D-23793
	6	100	55		1	D-23802
	8	100	55	1	D-23818	
	3	80	35	1/4inch Hex NZ	1	D-31463
	3.2	80	35		1	D-63694
	4	80	35		1	D-31479
	5	90	45		1	D-31485
	6	100	55		1	D-31491
6.5	100	55	1		D-55061	
8	100	55	1	D-31500		

Drill bit assortment in plastic case



Range	Diameter mm(inch)	Sales Pkg Qty	Part No.
★★★★☆	Metal 5, 6, 8, Wood 6, 8	5	D-30106
	-(Metal 3/16, 1/4, 5/16, Wood 1/4, 5/16)	5	D-30112
	Masonry 5.5, 7, 8, Metal 5.5, 7, 8, Wood 5.5, 7, 8	9	D-71978
	Masonry 5, 6, 8, Metal 5, 6, 8, Wood 5, 6, 8	9	D-71962
	Masonry 4 to 10, Metal 4 to 10, Wood 4 to 10	18	B-49432
	Masonry 3 to 8, Metal 3 to 8, Wood 3 to 8	21	B-44884

Drill bit assortment in metal case



Range	Diameter mm	Sales Pkg Qty	Part No.
★★★★☆	Masonry 3 to 10, Metal 3 to 10, Wood 3 to 10	18	D-46202

Drill bit with 1/4inch Hex shank assortment in plastic case



Range	Diameter mm	Shank Type	Sales Pkg Qty	Part No.
★★★★☆	Metal 5, 6, 8, Wood 5, 6	1/4inch Hex MZ	5	D-20769
	Masonry 6, Metal 5, 6, Wood 5, 6		5	D-23759
	Metal 5, 6, 8, Wood 5, 6	1/4inch Hex NZ	5	D-31516
	Masonry 6, Metal 5, 6, Wood 5, 6		5	D-31522

Drill bit for SDS-PLUS Hammers assortment in plastic case



Range	Diameter mm	Shank Type	Sales Pkg Qty	Part No.
★★★★☆	Metal 3, 4, Wood 4, 5, 6	SDS-PLUS	5	B-57532

Adjustable circle cutter

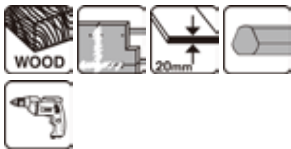

Range	Diameter mm	Sales Pkg Qty	Part No.
★★★★☆	30 ~ 120	1	D-57093
	30 ~ 200	1	D-57102

Adjustable circle cutter spare part



Range	Sales Pkg Qty	Part No.
★★★★☆	2	D-57118

Glass bit



Glass bit with 1/4inch Hex shank



Range	Diameter mm	Length mm	Shank Type	Sales Pkg Qty	Part No.
★★★★☆	4	65	1/4inch Hex MZ	1	D-15942
	5	65		1	D-15958
	6	65		1	D-15964
	8	70		1	D-15970
	10	80		1	D-15986
	4	65	1/4inch Hex NZ	1	D-31413
	5	65		1	D-31429
	6	65		1	D-31435
	8	70		1	D-31441
	10	80		1	D-31457

Range	Diameter mm	Length mm	Sales Pkg Qty	Part No.
★★★★☆	3	65	1	D-25111
	4	65	1	D-25127
	5	65	1	D-25133
	6	65	1	D-25149
	8	70	1	D-25155
	10	80	1	D-25161
	12	80	1	D-25177

Holesaw

Ezychange holesaw



Ezychange
Bi-Metal HSS 8%Co
Ezychange
TCT

One click
easy to change the holesaw



Easy to remove the dust
with pilot drill bit.



Added extension bar
(150/300mm)
for 13mm drill

Ezychange **Bi-Metal HSS 8%Co**



Variable pitch for faster cutting.

Thanks to 44mm capacity, users can drill into 38mm 2x4 material certainly.

It can make holes in 3mm thick stainless steel by HSS BiM with 8% Co.

Ezychange **TCT**



TCT for high durability.

Designed 60mm work length to be able to make a hole in composite material with plywood and 2x4 or 2x6 by 1 shot.

It can make holes in 3mm thick stainless steel and more material than BiM by TCT.

BiM holesaw

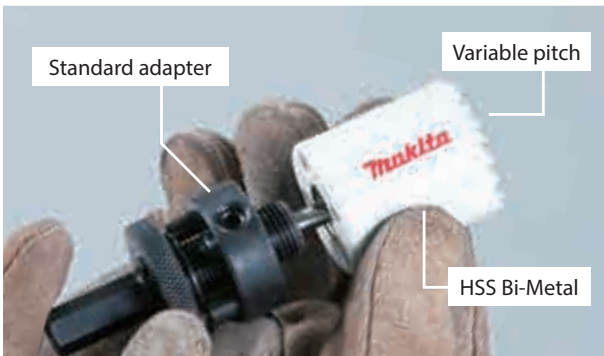

BiM holesaw for sheet metal

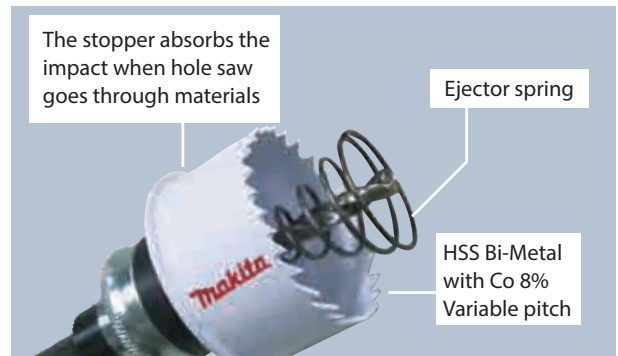

Multi purpose TCT holesaw

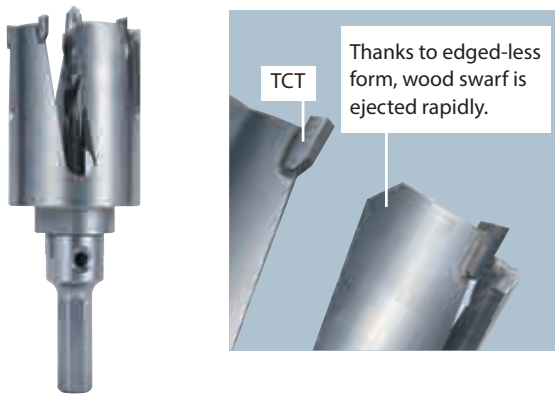

TCT holesaw

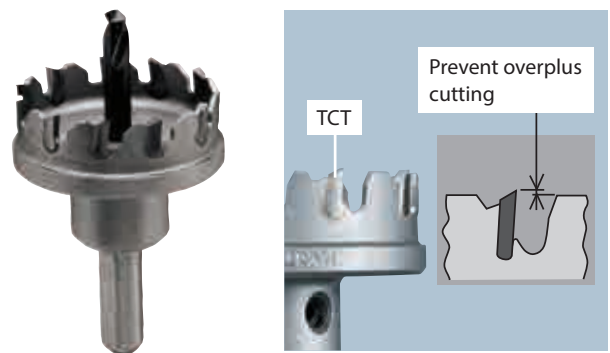

TC grit holesaw



Vacuum brazed diamond holesaw

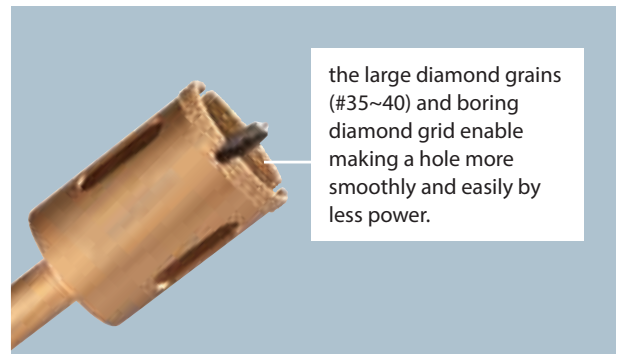

Diamond wet holesaw





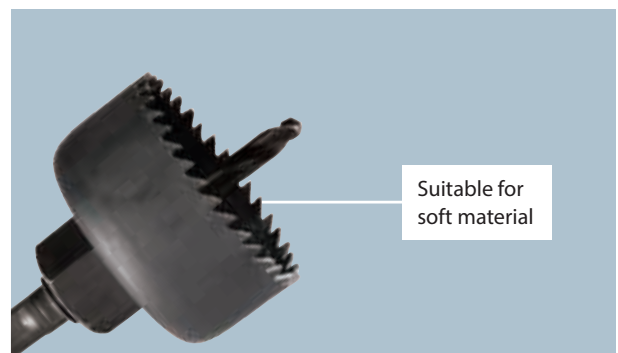



















Carbon steel holesaw

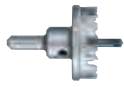

Material chart

AA : Recommended A : Acceptable

Application		Steel	Inox Stainless	Aluminum	Non ferrous Metal	Wood	MDF	Plaster board	PVC	FRP	Soft tile	Brick	Lime stone	Marble
														
BiM	<i>Ezychange</i> Bi-Metal HSS 8%Co 	AA	A	AA	AA	AA			AA					
	BiM 	AA		A	A	AA			AA					
	BiM for sheet metal 	AA	AA	A	A									
Tungsten carbide	<i>Ezychange</i> TCT 	AA	AA	AA	AA	AA			AA		A	A	A	
	Multi purpose TCT 					AA	AA	AA	AA	AA	A		A	
	TCT 	AA	AA	A	A				AA	AA				
	TC grit 										AA	AA		
Diamond	Vacuum brazed diamond 										AA	AA	AA	AA
	Diamond wet holesaw 										AA			AA
Carbon Steel	Carbon steel 					A		A	A					

Ezychange BiM holesaw



Range	Size mm	Note	Sales pkg q'ty	Part No.
★★★★☆	16	Cutting depth 44mm	1	E-03632
	17		1	E-03648
	19		1	E-03654
	20		1	E-03660
	22		1	E-03676
	24		1	E-03682
	25		1	E-03698
	27		1	E-03707
	29		1	E-03713
	30		1	E-03729
	32		1	E-03735
	35		1	E-03741
	37		1	E-03757
	38		1	E-03763
	40		1	E-03779
	41		1	E-03785
	44		1	E-03791
	46		1	E-03800
	48		1	E-03816
	51		1	E-03822
	52		1	E-03838
	54		1	E-03844
	56		1	E-03850
	57		1	E-03866
	60		1	E-03872
	64		1	E-03888
	65		1	E-03894
	67		1	E-14152
	68		1	E-03903
	70		1	E-03919
	73		1	E-03925
	76		1	E-03931
79	1	E-03947		
83	1	E-03953		
86	1	E-03969		
89	1	E-14168		
92	1	E-03975		
95	1	E-03981		
102	1	E-03997		
105	1	E-04008		
111	1	E-04014		
114	1	E-04020		
121	1	E-04036		
127	1	E-04042		
133	1	E-14174		
140	1	E-04058		
152	1	E-04064		

Ezychange BiM holesaw adapter



Range	Shank dia. mm	Note	Sales pkg q'ty	Part No.
★★★★☆	8.7	With HSS-G pilot drill bit	1	E-04070

Ezychange BIM holesaw pilot drill



Range	Size mm	Note	Sales pkg q'ty	Part No.
★★★★☆	85	For metal, etc (HSS-G)	1	E-04086
	85	For stainless (HSS-Co)	1	E-04092

Ezychange BiM holesaw assortment



Range	Shank dia. mm	Sales pkg q'ty	Part No.
★★★★☆	8.7	7	E-12304
		7	E-12310
		7	E-12326
		7	E-15805
		8	E-15780
		8	E-15796
		9	E-12295

Ezychange TCT holesaw



Range	Size mm	Note	Sales pkg q'ty	Part No.
★★★★☆	20	Cutting depth 60mm	1	E-06644
	22		1	E-06650
	25		1	E-06666
	32		1	E-06672
	35		1	E-06688
	38		1	E-06694
	40		1	E-06703
	44		1	E-06719
	51		1	E-06725
	54		1	E-06731
	60		1	E-06747
	64		1	E-06753
	67		1	E-06769
	68		1	E-06775
	70		1	E-06781
	73		1	E-06797
	76		1	E-06806
	83		1	E-06812
	102		1	E-06828
	127		1	E-06834

Ezychange TCT holesaw adapter

Ezychange
for TCT



Range	Shank dia. mm	Note	Sales pkg q'ty	Part No.
★★★★☆	8.7	With TCT pilot drill bit	1	E-06959

Ezychange TCT holesaw pilot drill

Ezychange
for TCT



Range	Size mm	Note	Sales pkg q'ty	Part No.
★★★★☆	105	For masonry (TCT)	1	E-06862
		For metal, etc (HSS-G)	1	E-06840
		For stainless (HSS-Co)	1	E-06856

Ezychange TCT holesaw assortment

Ezychange
for TCT



Range	Shank dia. mm	Sales pkg q'ty	Part No.
★★★★☆	8.7	8	E-14261

Ezychange holesaw extension bar

Ezychange
Bi-Metal HSS 8%Co

Ezychange
for TCT



Range	Size mm	Shank dia. mm	Note	Sales pkg q'ty	Part No.
★★★★☆	150	11	For Ezychange BiM/TCT Holesaw	1	E-06878
	300			1	E-06884

BiM holesaw

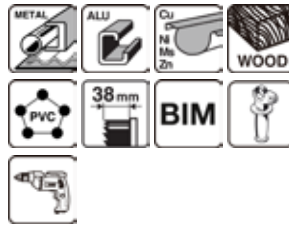

Range	Size mm	Note	Sales pkg q'ty	Part No.
	14		1	D-35368
	16		1	D-16994
	17		1	D-35374
	19		1	D-17005
	20		1	D-17251
	21		1	D-35380
	22		1	D-17011
	24		1	D-17027
	25		1	D-17033
	27		1	D-35396
	29		1	D-17267
	30		1	D-35405
	32		1	D-17049
	33		1	D-35411
	35		1	D-17055
	37		1	D-35427
	38		1	D-17061
	40		1	D-17273
	41		1	D-35433
	43		1	D-35449
	44		1	D-17077
	46		1	D-35455
	48		1	D-35461
	51		1	D-17083
	52		1	D-35477
	54		1	D-24876
★★★★☆	56	Cutting depth 38mm	1	D-35483
	57		1	D-17099
	59		1	D-35499
	60		1	D-25688
	64		1	D-30140
	65		1	D-24882
	67		1	D-35508
	68		1	D-17108
	70		1	D-25694
	73		1	D-35514
	76		1	D-17114
	79		1	D-35520
	80		1	D-33869
	83		1	D-17120
	86		1	D-35536
	89		1	D-35542
	92		1	D-17136
	95		1	D-35558
	98		1	D-35564
	102		1	D-35570
	105		1	D-17142
	108		1	D-35586
	111		1	D-35592
	114		1	D-35601
	121		1	D-35617
	127		1	D-17158
	140		1	D-35623
	152		1	D-17164

BiM holesaw adapter



Range	Type	Shank dia. mm	Note	Sales pkg q'ty	Part No.
★★★★☆	Adapter	9.5	For 14-30mm, With pilot drill bit	1	D-17170
			For 32-165mm, With pilot drill bit	1	D-62278
	SDS-PLUS adapter	-	For 32-152mm, With pilot drill bit	1	D-17186
			For 14-30mm, With pilot drill bit	1	D-17603
			For 32-76mm, With pilot drill bit	1	D-17619

BiM holesaw pilot drill



Range	Size mm	Sales pkg q'ty	Part No.
★★★★☆	71	1	D-17192

BiM holesaw assortment



Range	Shank dia. mm	Sales pkg q'ty	Part No.
★★★★☆	9.5	5	D-34855
		5x14sets	D-33641-14
		6x10sets	D-33657-10
		6x14sets	D-33819-14
		7x10sets	D-33825-10
	9.5, 11	6	D-34861
		9	D-47117
		9	D-47123
		9	D-47139
		9	D-63965
		12	D-47282
		12	D-60953
		12	D-63987
		13	D-75764
		14	D-47298
		14	D-50572
		14	D-60969
		14	D-63971
		16	D-47307
		16	D-60975
16	D-63993		

BiM holesaw for sheet metal



Range	Size mm	Note	Sales pkg q'ty	Part No.
★★★★☆	16	Cutting depth 20mm	1	B-29670
	17		1	B-29686
	19		1	B-29692
	20		1	B-29701
	21		1	B-29717
	22		1	B-29723
	25		1	B-29739
	27		1	B-29745
	29		1	B-29751
	30		1	B-29767
	32		1	B-29773
	33		1	B-29789
	35		1	B-29795
	38		1	B-29804
	40		1	B-29810
	41		1	B-29826
	44		1	B-29832
	48		1	B-29848
	51		1	B-29854
	54		1	B-29860
	57		1	B-29876
	60		1	B-29882
	64		1	B-29898
	65		1	B-35994
	67		1	B-36005
	68		1	B-36011
	70		1	B-36027
	73		1	B-36033
	76		1	B-36049
	79		1	B-36055
83	1	B-36061		
86	1	B-36077		
89	1	B-36083		
102	1	B-36099		
127	1	B-36108		
152	1	B-36114		

BiM holesaw for sheet metal adapter



Range	Shank dia. mm	Note	Sales pkg q'ty	Part No.
★★★★☆	9.5	For 16-35mm, With HSS pilot drill bit	1	B-36120
	11	For 38-152mm, With HSS pilot drill bit	1	B-36136

BiM holesaw for sheet metal pilot drill



Range	Size mm	Sales pkg q'ty	Part No.
★★★★☆	60	1	B-36142

BiM holesaw for sheet metal assortment



Range	Shank dia. mm	Sales pkg q'ty	Part No.
★★★★☆	9.5, 11	15	B-38663
	9.5, 11	15	B-38679

TCT holesaw



Range	Size mm	Shank dia. mm	Note	Sales pkg q'ty	Part No.
★★★★★	16	6	With pilot drill bit	1	B-00898
	18	6		1	B-00907
	20	6		1	B-00913
	21	6		1	B-00929
	22	6		1	B-00935
	25	10		1	B-00941
	27	10		1	B-00957
	28	10		1	B-00963
	30	10		1	B-00979
	32	10		1	B-00985
	35	10		1	B-00991
	38	10		1	B-01002
	40	10		1	B-01018
	45	10		1	B-01024
	48	10		1	B-01030
	50	10		1	B-01046
	55	10		1	B-01052

TCT holesaw pilot drill



Range	Size mm	Note	Sales pkg q'ty	Part No.
★★★★★	48	For 16-55mm, For metal, etc.	1	B-01177

Multi purpose TCT holesaw

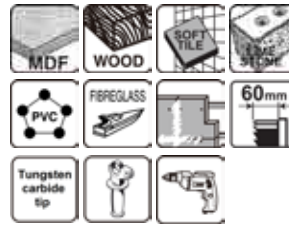

Range	Size mm	Note	Sales pkg q'ty	Part No.
★★★★☆	19	Cutting depth 50mm	1	D-42678
	22		1	D-42684
	25		1	D-42690
	29		1	D-42709
	30		1	D-42715
	32		1	D-42721
	35		1	D-42737
	38		1	D-42743
	40		1	D-42759
	45		1	D-42765
	48	1	D-42771	
	50	1	D-42787	
	51	1	D-42793	
	54	1	D-42802	
	55	1	D-42818	
	57	1	D-42824	
	59	Cutting depth 60mm	1	D-61488
	60		1	D-42830
	64		1	D-42846
	65		1	D-42852
67	1		D-42868	
68	1		D-42874	
70	1		D-42880	
73	1		D-45026	
76	1		D-45032	
79	1		D-45048	
80	1	D-45331		
83	1	D-45347		
85	1	D-45353		
89	1	D-45369		
95	1	D-50304		
102	1	D-50310		
105	1	D-50326		

Multi purpose TCT holesaw adapter



Range	Type	Shank dia. mm	Note	Sales pkg q'ty	Part No.
★★★★☆	Adapter	11	For 19mm, With HSS pilot drill bit	1	D-50398
		11	For 19mm, With TCT pilot drill bit	1	D-50354
		11	For 22-105mm, With HSS pilot drill bit	1	D-50376
		11	For 22-105mm, With TCT pilot drill bit	1	D-50332
	SDS-PLUS adapter	-	For 19mm, With HSS pilot drill bit	1	D-50407
		-	For 19mm, With TCT pilot drill bit	1	D-50360
		-	For 22-32mm, With HSS pilot drill bit	1	D-50382
		-	For 22-32mm, With TCT pilot drill bit	1	D-50348

Multi purpose TCT holesaw pilot drill



Range	Size mm	Note	Sales pkg q'ty	Part No.
★★★★☆	90	For 19mm, For masonry(TCT)	1	D-50441
		For 19mm, For metal, etc(HSS)	1	D-50435
	100	For 22-105mm, For masonry(TCT)	1	D-50429
		For 22-105mm, For metal, etc(HSS)	1	D-50413

Multi purpose TCT holesaw assortment



Range	Shank dia. mm	Sales pkg q'ty	Part No.
★★★★☆	11	9	D-51297
	11	10	D-51281

Tungsten carbide grit holesaw



Range	Size mm	Note	Sales pkg q'ty	Part No.
★★★★☆	33	Cutting depth 64mm	1	D-51188
	43		1	D-51194
	53		1	D-51203
	63		1	D-51219
	67		1	D-51225
	73		1	D-51231
	83		1	D-51247

Tungsten carbide grit holesaw adapter



Range	Shank dia. mm	Note	Sales pkg q'ty	Part No.
★★★★☆	11	With TCT pilot drill bit	1	D-51253

Tungsten carbide grit holesaw pilot drill



Range	Size mm	Note	Sales pkg q'ty	Part No.
★★★★☆	90	TCT	1	D-51269

Vacuum brazed diamond holesaw



Range	Size mm	Shank dia. mm	Note	Sales pkg q'ty	Part No.			
	16	12.7	Cutting depth 40mm, With shank and pilot drill bit	1	B-45870			
	19			1	B-45886			
	25			1	B-45892			
	30			1	B-45901			
	32			1	B-45917			
	35			1	B-45923			
	38			1	B-45939			
	45			1	B-45945			
	50			1	B-45951			
	53			1	B-45967			
	57			1	B-45973			
	64			1	B-45989			
	★★★★☆			16	-	Cutting depth 40mm	1	B-45995
	19			1			B-46006	
	25			1			B-46012	
	30			1			B-46028	
32	1	B-46034						
35	1	B-46040						
38	1	B-46056						
45	1	B-46062						
50	1	B-46078						
53	1	B-46084						
57	1	B-46090						
64	1	B-46109						
	68			1	B-53914			

Vacuum brazed diamond holesaw adapter



Range	Type	Shank dia. mm	Note	Sales pkg q'ty	Part No.
★★★★☆	Adapter	12.7	-	1	B-46137
			With TCT pilot drill bit	1	B-46115
	SDS-PLUS adapter	-	-	1	B-52700
			With pilot drill bit	1	B-52691

ACCESSORIES

▣ Drilling (Masonry)



Metal, mild steel



Aluminum



Wood



Tile



Concrete



Reinforced concrete



Brick



Stone



Asphalt



Plastic



Mine



2cutter



4cutter



Centering tip



Self sharpening



Dustless

TCT drill bit with Straight shank

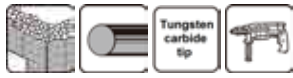

Range	Bit dia mm	Length mm	Working Length mm	Sales Pkg Qty	Part No.
★★★★☆	3	60	30	1	E-06351
	4	70	35	1	E-06367
	5	85	45	1	E-06373
	5	150	90	1	E-06389
	5.5	100	60	1	E-06395
	5.5	150	90	1	E-06404
	6	100	60	1	E-06410
	6	150	90	1	E-06426
	6	250	175	1	E-06432
	6.5	100	60	1	E-06448
	6.5	150	90	1	E-06454
	7	100	55	1	E-06460
	7	150	90	1	E-06476
	8	110	60	1	E-06482
	8	150	90	1	E-06498
	8	250	175	1	E-06507
	9	150	90	1	E-06513
	10	150	90	1	E-06529
	10	250	175	1	E-06535
	★★★☆☆	12	150	90	1
12		250	175	1	E-06557
14		150	85	1	E-06563
14		250	175	1	E-06579
16		150	85	1	E-06585
18		200	135	1	E-06591
20		200	135	1	E-06600
3		60	30	1	D-05228
4		70	35	1	D-05234
5		85	45	1	D-05240
5.5		100	60	1	D-36728
5.5		150	90	1	D-36734
6		100	60	1	D-05256
6		150	90	1	D-05262
6.5		100	55	1	D-36740
6.5		150	90	1	D-36756
7		100	55	1	D-05278
7		150	90	1	D-05284
8		110	60	1	D-05290
8		150	90	1	D-05309
9	150	90	1	D-05315	
10	150	90	1	D-05321	
10	400	315	1	D-18960	
11	150	90	1	D-05337	
12	150	90	1	D-05343	
12	400	315	1	D-17697	
12	600	505	1	D-17728	
13	150	85	1	D-05359	
14	150	85	1	D-05365	
14	400	315	1	D-18976	
15	150	85	1	D-05371	
16	150	85	1	D-05387	
16	400	315	1	D-17706	
16	600	505	1	D-17734	
18	400	315	1	D-18982	
20	400	315	1	D-17712	
20	600	505	1	D-17740	

TCT drill bit with Straight shank multiple

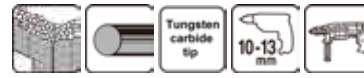

Range	Bit dia mm	Length mm	Working Length mm	Sales Pkg Qty	Part No.
★★★★☆	3	60	30	5	D-71788
	4	70	35	5	D-71794
	5	85	45	5	D-71803
	6	100	60	5	D-71819
	6	150	90	5	D-71825
	6.5	100	55	5	D-71831
	7	100	60	5	D-16508
	8	110	60	5	D-16514
	8	110	60	5	D-71847
	8	150	90	5	D-71853
	10	150	90	5	D-71869

TCT drill bit with Straight shank assortment in plastic case

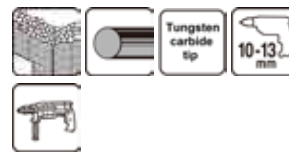

Range	Size mm	Sales Pkg Qty	Part No.
★★★★☆	4x70, 5x85, 6x100, 8x110, 10x150	5	E-11536
	3x60, 4x70, 5x85, 6x100, 6x150, 8x110, 8x150, 10x150	8	E-15861
★★★☆☆	5x85, 5.5x100, 6.5x100, 8x150, 10x150	5	D-36762
	5x110, 6x110, 7x110, 8x110, 10x110	5	D-20719
	4x70, 5x85, 6x100, 8x110, 10x110	5	D-05175
	4x70, 5x85, 5.5x85, 5.5x85, 6x100, 6x100, 6.5x100, 6.5x100, 7x100, 7x100, 8x110, 8x110	12	D-73483
	4x70, 5x85, 5x85, 6x100, 6x100, 6x100, 8x110, 8x110, 10x150, 10x150, 12x150	12	D-77126

TCT drill bit with Straight shank Brick



Range	Bit dia mm	Length mm	Working Length mm	Sales Pkg Qty	Part No.
★★★★☆	3	60	30	1	D-40727
	3.5	75	40	1	D-40733
	4	75	40	1	D-40749
	4.5	85	55	1	D-40755
	5	85	55	1	D-40761
	5	150	100	1	D-40777
	5.5	85	55	1	D-40783
	5.5	150	100	1	D-40799
	6	100	60	1	D-40808

Range	Bit dia mm	Length mm	Working Length mm	Sales Pkg Qty	Part No.
★★☆☆☆	6	150	100	1	D-40814
	6	200	130	1	D-40820
	6	400	350	1	D-40836
	6.5	100	60	1	D-40842
	6.5	150	100	1	D-40858
	6.5	400	350	1	D-40864
	7	100	60	1	D-40870
	7	150	100	1	D-40886
	7	400	350	1	D-40892
	8	120	80	1	D-40901
	8	150	100	1	D-40917
	8	200	130	1	D-40923
	8	400	350	1	D-40939
	9	120	80	1	D-40945
	10	120	80	1	D-40951
	10	150	100	1	D-40967
	10	200	130	1	D-40973
	10	400	350	1	D-40989
	11	150	100	1	D-40995
	12	150	100	1	D-41006
12	200	130	1	D-41012	
12	400	350	1	D-41028	

TCT drill bit with Straight shank Multi material

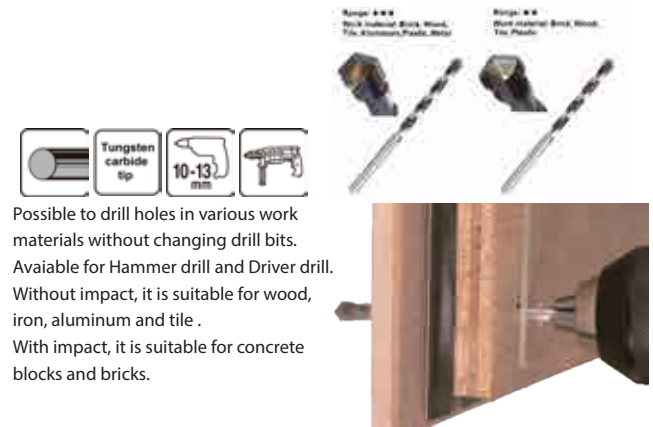

Possible to drill holes in various work materials without changing drill bits. Available for Hammer drill and Driver drill. Without impact, it is suitable for wood, iron, aluminum and tile. With impact, it is suitable for concrete blocks and bricks.

4-side grinding and sharp cutting edge

It makes possible to drill holes in various work materials and also improves drilling speed.

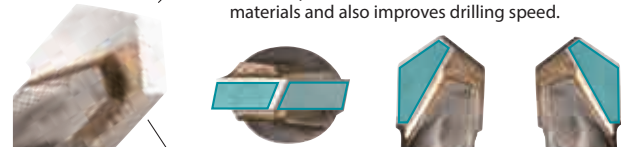

Outstanding durability

High quality tungsten carbide tip is used.

*Range (★★) can't use metal drilling.

TCT drill bit with Straight shank Brick assortment

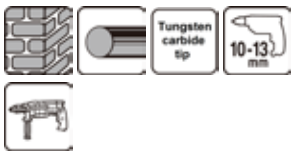
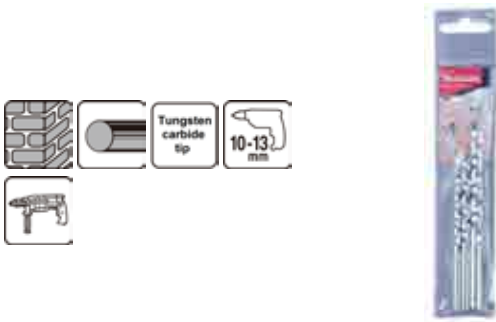

Range	Size mm	Sales Pkg Qty	Part No.
★★☆☆☆	5x85, 6x100, 8x120	3	D-41034

TCT drill bit with Straight shank Brick assortment in plastic case

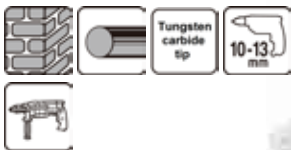
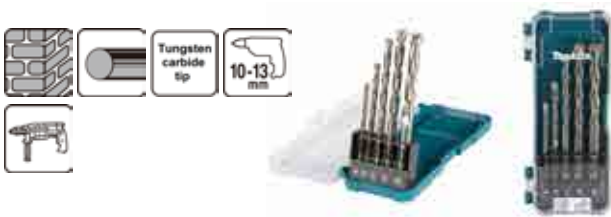

Range	Size mm	Sales Pkg Qty	Part No.
★★☆☆☆	4x75, 5x85, 6x100, 8x120, 10x120	5	D-72877

Range	Bit dia mm	Length mm	Working Length mm	Sales Pkg Qty	Part No.
★★☆☆☆	3	70	38	1	E-10958
	4	75	40	1	E-10964
	5	85	43	1	E-10970
	5.5	100	50	1	E-10986
	6	100	50	1	E-10992
	6	150	90	1	E-11003
	6.5	100	50	1	E-11019
	6.5	150	90	1	E-11025
	7	100	50	1	E-11031
	8	120	60	1	E-11047
	8	150	90	1	E-11053
	10	150	90	1	E-11069
	12	150	90	1	E-11075
	13	150	90	1	E-11081
	★★☆☆☆	3	60	28	1
4		70	35	1	D-30293
5		85	43	1	D-30302
5.5		85	43	1	D-31027
5.5		100	58	1	D-31033
5.5		150	108	1	D-31049
6		100	58	1	D-30318
6		150	108	1	D-30324
6		200	120	1	D-72774
6		250	170	1	D-72780
6		300	200	1	D-72796
6.5		85	43	1	D-31055
6.5		100	58	1	D-31061
6.5		150	108	1	D-31077
6.5		200	120	1	D-72805
6.5		250	170	1	D-72811
6.5		300	200	1	D-72827
7		100	53	1	D-30330
7		150	103	1	D-30346
8		110	57	1	D-30352
8		150	97	1	D-30368
9		150	97	1	D-30374
10		150	97	1	D-30380
10		400	300	1	D-30396
11		150	93	1	D-30405
12		150	93	1	D-30411
12		400	300	1	D-30427
12		600	500	1	D-30433
13		150	85	1	D-30449
14		150	85	1	D-30455
14	400	300	1	D-30461	

TCT drill bit with Straight shank Multi material multiple

Omnibohrer



Range	Bit dia mm	Length mm	Working Length mm	Sales Pkg Qty	Part No.
★★★★☆	3	60	28	5	D-71875
	4	70	35	5	D-71881
	5	85	43	5	D-71897
	6	100	58	5	D-71906
	6	150	108	5	D-71912
	8	110	57	5	D-71928
	8	150	97	5	D-71934
	10	150	97	5	D-71940

TCT drill bit with Straight shank Multi material assortment in plastic case



Range	Size mm	Sales Pkg Qty	Part No.
★★★★☆	4x75, 5x85, 6x100, 8x120, 10x150	5	E-14255
	3x70, 4x75, 5x85, 6x100, 6x150, 8x120, 8x150, 10x150	8	E-15855
★★★★☆	5.5x85, 6.5x100, 8x110, 10x150, 12x150	5	D-36974
	4x70, 5x85, 6x100, 8x150, 10x150	5	D-36712
	5x85, 6x100, 8x110, 10x150, 12x150	5	D-30477

TCT drill bit with 1/4inch Hex shank Multi material



Range	Shank Type	Bit dia mm	Length mm	Working Length mm	Sales Pkg Qty	Part No.
★★★★☆	1/4inch Hex MZ	3	90	45	1	E-14934
		4	90	45	1	E-14940
		5	100	50	1	E-14956
		5.5	100	50	1	E-14962
		5.5	150	90	1	E-14978
		6	100	50	1	E-14984
		6	150	90	1	E-14990
		6.5	100	50	1	E-15001
		6.5	150	90	1	E-15017
		7	100	50	1	E-15023
		7	150	90	1	E-15039
		8	120	60	1	E-15045
		8	150	90	1	E-15051
		10	150	90	1	E-15067
		12	150	90	1	E-15073
		13	150	90	1	E-15089
		3	90	45	1	E-16651
		4	90	45	1	E-16667
		5	100	50	1	E-16673
		6	100	50	1	E-16689
		6.5	100	50	1	E-16695
		8	120	60	1	E-16704
		10	150	90	1	E-16710
		12	150	90	1	E-16726











TCT drill bit with 1/4inch Hex shank Multi material assortment in plastic case

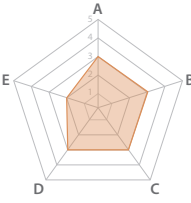
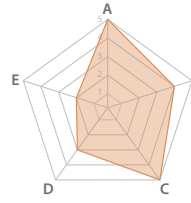

Range	Shank Type	Bit dia mm	Length mm	Working Length mm	Sales Pkg Qty	Part No.
★★★★☆	1/4inch Hex MZ	4,5,6,8,10	90, 100, 120, 150	45, 50, 60, 90	5	E-16732
		4,5,6,8,10	90, 100, 120, 150	45, 50, 60, 90	5	E-17974

T.C.T drill bit for SDS-PLUS Hammers













Product	Standard type	Centering Tip	Centering Tip V-PLUS	4 cutter	NEMESIS II
Range	★★	★★★	★★★★	★★★	★★★★★
Carbide					
Tip	2 Cutter	Centering tip 2 Cutter	Centering tip 2 Cutter	Centering tip 4 Cutter	*Full carbide tip 4 Cutter 
Flute	Standard 2 flute	Standard 2 flute	High Durability 2 flute	Standard 2 flute	High Durability 4 flute
Size	3.5 - 30mm 5/32" - 1"	4 - 32mm 5/32" - 1"	3.5-26mm	5 - 25mm	5 - 32mm 5/32" - 1-1/4"
Chart					
Work material					

*Full carbide spec is only for dia. 5 to 16mm

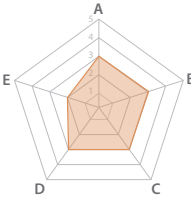
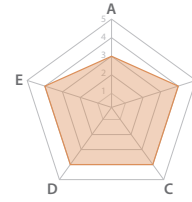
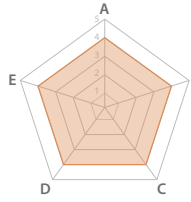
T.C.T drill bit for SDS-MAX Hammers



Product	Standard type	4 cutter	NEMESIS	Mining
Range	★★	★★★	★★★★	Specialized
Carbide				
Tip	2 Cutter	Centering tip 4 cutter	Centering tip 4 Cutter 	4 Cutter 
Flute	Standard 2 flute	Standard 2 flute	High Durability 4 flute	High Durability 2 flute
Size	12-40mm 1/2" - 1-1/2"	12-30mm	12-40mm 1/2" - 1-1/2"	28-32mm
Chart				Specialized
Work material				

TCT drill bit for SDS-PLUS hammers



Range	Bit dia mm	Length mm	Working Length mm	Sales Pkg Qty	Part No.
★★☆☆☆	3.5	90	30	1	D-16950
	3.5	110	50	1	D-15665
	4	110	50	1	D-00016
	4	160	100	1	D-66612
	4.3	110	50	1	D-01096
	5	110	50	1	D-00022
	5	160	100	1	D-00038
	5	210	150	1	D-66628
	5.5	110	50	1	D-00044
	5.5	160	100	1	D-16106
	5.8	110	50	1	D-03268
	6	110	50	1	D-00050
	6	160	100	1	D-00066
	6	210	150	1	D-00072
	6	260	200	1	D-25666
	6.4	160	100	1	D-01105
	6.5	110	50	1	D-00088
	6.5	160	100	1	D-00094
	6.5	210	150	1	D-45082
	6.5	260	200	1	D-66634
	7	110	50	1	D-00103
	7	160	100	1	D-00119
	7	210	150	1	D-25600
	8	110	50	1	D-00125
	8	160	100	1	D-00131
	8	210	150	1	D-00147
	8	260	200	1	D-00153
	8	310	250	1	D-66640
	8	460	400	1	D-29206
	8	600	540	1	D-29212
	8.5	160	100	1	D-01111
	9	110	50	1	D-08040
	9	160	100	1	D-08056
	9	210	150	1	D-00169
	9.5	160	100	1	D-34344
	9.5	210	150	1	D-03274
	10	110	50	1	D-09117
	10	160	100	1	D-00175
	10	210	150	1	D-00181
	10	260	200	1	D-00197
	10	310	250	1	D-00206
	10	350	290	1	D-66656
	10	460	400	1	D-17538
	10	600	540	1	D-29147
	10.5	160	100	1	D-01127
	11	160	100	1	D-00212
	11	210	150	1	D-66662
	11	260	200	1	D-66678
	12	160	100	1	D-00228
	12	210	150	1	D-00234
12	260	200	1	D-00240	
12	310	250	1	D-66684	
12	350	290	1	D-16112	
12	460	400	1	D-16271	
12	600	540	1	D-29153	
12.5	160	100	1	D-14102	
12.7	160	100	1	D-03280	
12.7	350	290	1	D-03296	
13	160	100	1	D-00256	
13	210	150	1	D-66690	
13	260	200	1	D-25622	
13	350	290	1	D-16128	
14	160	100	1	D-00262	
14	210	150	1	D-21331	
14	260	200	1	D-00278	
14	310	250	1	D-66709	
14	350	290	1	D-16134	
14	460	400	1	D-17544	
14.3	160	100	1	D-03997	

Range	Bit dia mm	Length mm	Working Length mm	Sales Pkg Qty	Part No.
★★★★☆	14.5	160	100	1	D-01149
	15	160	100	1	D-00284
	15	260	200	1	D-25638
	15	350	290	1	D-16140
	15	460	400	1	D-17550
	16	160	100	1	D-03981
	16	210	150	1	D-00290
	16	260	200	1	D-16156
	16	310	250	1	D-00309
	16	350	290	1	D-16162
	16	460	400	1	D-16287
	16	460	400	1	D-29103
	16	600	540	1	D-29169
	17	160	100	1	D-16178
	17	210	150	1	D-00315
	17	260	200	1	D-16184
	17	350	290	1	D-16190
	17.5	160	100	1	D-03305
	18	160	100	1	D-16209
	18	210	150	1	D-00321
	18	260	200	1	D-16215
	18	300	240	1	D-00337
	18	350	290	1	D-16221
	18	460	400	1	D-17566
	19	210	150	1	D-00343
	19	350	290	1	D-16243
	19	460	400	1	D-16293
	20	210	150	1	D-00359
	20	260	200	1	D-16259
	20	310	250	1	D-00365
	20	350	290	1	D-16265
	20	460	400	1	D-15235
	20	600	540	1	D-29175
	22	260	200	1	D-00371
	22	310	250	1	D-08062
	22	460	400	1	D-15241
	22	600	540	1	D-29181
	24	260	200	1	D-25644
	24	460	400	1	D-16302
	25	260	200	1	D-00387
	25	310	250	1	D-08517
	25	350	290	1	D-03311
	25	460	400	1	D-15257
	25	600	540	1	D-29197
	26	260	200	1	D-00393
	26	310	250	1	D-08078
	26	460	400	1	D-15263
	28	460	400	1	D-16318
	30	460	400	1	D-17572

TCT drill bit for SDS-PLUS hammers multiple



Range	Bit dia mm	Length mm	Working Length mm	Sales Pkg Qty	Part No.
★★★★☆	5	110	50	25	D-01155-25
	5	110	50	25	D-65115
	5	160	100	25	D-61949
	5	160	100	50	D-61955
	5.5	110	50	25	D-03763-25
	5.5	160	100	25	D-03779-25
	6	110	50	25	D-01161-25
	6	110	50	25	D-61612
	6	110	50	50	D-61628
	6	160	100	25	D-01177-25
	6	160	100	25	D-61961
	6	160	100	50	D-61977
	6.5	110	50	25	D-03785-25
	6.5	110	50	25	D-61983
	6.5	110	50	50	D-61999
	6.5	160	100	25	D-03791-25
	6.5	160	100	25	D-62000

Range	Bit dia mm	Length mm	Working Length mm	Sales Pkg Qty	Part No.
★★★★☆	6.5	160	100	50	D-62016
	6.5	210	150	10	D-45098
	6.5	210	150	25	D-45107
	7	110	50	25	D-03800-25
	7	160	100	25	D-03816-25
	7	160	100	25	D-62131
	7	160	100	50	D-62147
	8	110	50	25	D-61634
	8	110	50	50	D-61640
	8	160	100	25	D-01183-25
	8	160	100	25	D-62022
	8	160	100	50	D-62038
	8	210	150	25	D-01199-25
	8	210	150	25	D-65121
	8	260	200	25	D-06161-25
	10	110	50	25	D-61656
	10	110	50	50	D-61662
	10	160	100	25	D-01208-25
	10	160	100	25	D-62044
	10	160	100	50	D-62050
	10	210	150	25	D-03707-25
	10	210	150	25	D-65137
	12	160	100	25	D-03713-25
	12	160	100	25	D-62066
	12	160	100	50	D-62072
	12	210	150	15	D-65143
	12	210	150	25	D-03729-25
	12	260	200	15	D-65159
	12	350	290	15	D-65165
	13	160	100	15	D-65171
14	160	100	15	D-65187	
14	210	150	15	D-65193	
16	160	100	15	D-65202	
16	210	150	15	D-65218	

Range	Size mm	Sales Pkg Qty	Part No.
★★★★☆	5x110, 6x110, 6x160, 8x110, 8x160	5	D-00795
	5x160, 6x160, 6x160, 8x160, 8x160	5	D-58914
	5x160, 6x160, 7x160, 8x160, 10x160	5	D-20703
	6x110, 6x160, 8x110, 8x160, 10x160	5	D-61678
	6x160, 6x160, 8x160, 10x160, 12x160	5	D-36049
	5x110, 6x110, 6x160, 8x110, 8x160	10	D-40593
	6x160, 8x160, 10x160, 12x160	12	D-62723
	5x110, 6x110, 6x160, 7x110, 7x160	25	D-33853
	5x110, 6x110, 6x160, 8x110, 8x160	25	D-40602
	5.5x110, 5.5x160, 6.5x110, 6.5x160, 8x160	25	D-46268

TCT drill bit for SDS-PLUS hammers assortment in roll up pouch



Range	Size mm	Sales Pkg Qty	Part No.
★★★★☆	5x110, 6x110, 6x160, 7x110, 7x160, 8x110, 8x160, 10x160, 10x210, 12x160, 12x210, 14x160, 14x210, 16x210	14	D-53671

TCT drill bit for SDS-PLUS hammers assortment in cardboard box



Range	Size mm	Sales Pkg Qty	Part No.
★★★★☆	5x110, 6x110, 7x110, 8x110, 6x160, 7x160, 8x160, 10x160, 12x160, 14x160, 10x210, 12x210, 14x210, 16x210	14	D-71956

TCT drill bit for SDS-PLUS hammers assortment in aluminum case



Range	Size mm	Sales Pkg Qty	Part No.
★★★★☆	5x110, 6x110, 6x160, 7x110, 7x160, 8x110, 8x160, 10x160, 10x210, 12x160, 12x210, 14x160, 14x210, 16x210	14	D-21325

TCT drill bit for SDS-PLUS hammers assortment in plastic case



Range	Size mm	Sales Pkg Qty	Part No.
★★★★☆	6.5x160, 8x160, 10x160, 12x160	4	D-74728
	5x110, 6x160, 8x160, 10x160	4	D-74136
	6x160, 8x160, 10x160, 12x160	4	D-74756
	5.5x110, 6x160, 7x110, 7x160, 8x160	5	D-03888
	5.8x110, 6.5x110, 6.5x160, 9.5x160, 12.7x160	5	D-44987
	6x110, 6.5x110, 8x160, 10x160, 12x160	5	D-17784

TCT drill bit for SDS-PLUS hammers assortment in aluminum case with Makita blue



Range	Size mm	Sales Pkg Qty	Part No.
★★★★☆	5x110, 6x110, 6x160, 7x110, 7x160, 8x110, 8x160, 10x160, 10x210, 12x160, 12x210, 14x160, 14x210, 16x210	14	D-42422

TCT drill bit for SDS-PLUS hammers Centering tip

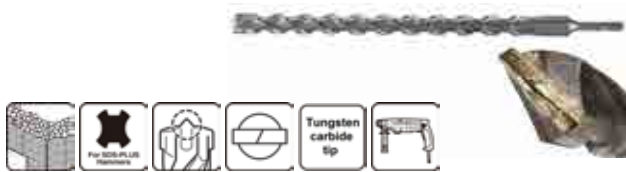

	Bit dia mm	Length mm	Working Length mm	Sales Pkg Qty	Part No.
	4	110	50	1	B-55859
	4	160	100	1	B-67804
	5	110	50	1	B-54128
	5	160	100	1	B-54134
	5	210	150	1	B-67810
	5.5	110	50	1	B-55865
	5.5	160	100	1	B-55871
	5.5	210	150	1	B-67826
	6	110	50	1	B-54140
	6	160	100	1	B-54156
	6	210	150	1	B-54162
	6	260	200	1	B-67832
	6.5	110	50	1	B-55887
	6.5	160	100	1	B-55893
	6.5	210	150	1	B-55902
	6.5	260	200	1	B-55918
	7	110	50	1	B-55924
	7	160	100	1	B-55930
	7	210	150	1	B-55946
	8	110	50	1	B-54178
	8	160	100	1	B-54184
	8	210	150	1	B-55952
	8	260	200	1	B-55968
	8	310	250	1	B-67848
	8	400	340	1	B-67854
	8	460	400	1	B-68046
	9	160	100	1	B-55974
	9	210	150	1	B-67860
	10	110	50	1	B-55980
	10	160	100	1	B-54190
	10	210	150	1	B-54209
	10	260	200	1	B-55996
	10	310	250	1	B-56007
	10	350	290	1	B-67876
★★★★☆	10	450	400	1	B-56013
	11	160	100	1	B-67882
	11	210	150	1	B-67898
	11	260	200	1	B-67907
	12	160	100	1	B-54215
	12	210	150	1	B-54221
	12	260	200	1	B-56029
	12	310	250	1	B-67913
	12	350	290	1	B-56035
	12	450	400	1	B-56041
	13	160	100	1	B-56057
	13	210	150	1	B-67929
	13	260	200	1	B-67935
	14	160	100	1	B-56063
	14	210	150	1	B-56079
	14	260	200	1	B-56085
	14	310	250	1	B-67941
	14	350	290	1	B-56091
	14	450	400	1	B-56100
	15	160	100	1	B-67957
	15	260	200	1	B-67963
	15	460	400	1	B-68052
	16	160	100	1	B-56116
	16	210	150	1	B-56122
	16	260	200	1	B-67979
	16	310	250	1	B-56138
	16	350	290	1	B-56144
	16	450	400	1	B-56150
	17	210	140	1	B-56465
	17	350	270	1	B-56471
	18	210	150	1	B-62125
	18	310	250	1	B-67985
	18	350	290	1	B-62131
	18	460	400	1	B-68068
	19	210	150	1	B-62147

	Bit dia mm	Length mm	Working Length mm	Sales Pkg Qty	Part No.
	19	350	290	1	B-62153
	20	210	150	1	B-62169
	20	310	250	1	B-67991
	20	350	290	1	B-62175
	20	460	400	1	B-68074
	22	210	150	1	B-62181
	22	260	200	1	B-68002
	22	350	290	1	B-62197
	22	460	400	1	B-68080
	24	210	150	1	B-62206
	24	260	200	1	B-68018
★★★★☆	24	350	290	1	B-62212
	24	460	400	1	B-68096
	25	210	150	1	B-62228
	25	260	200	1	B-68024
	25	350	290	1	B-62234
	25	460	400	1	B-68105
	26	260	200	1	B-68030
	26	460	400	1	B-68111
	28	210	150	1	B-62240
	28	350	290	1	B-62256
	30	210	150	1	B-62262
	30	350	290	1	B-62278
	32	350	290	1	B-62284

TCT drill bit for SDS-PLUS hammers Centering tip multiple

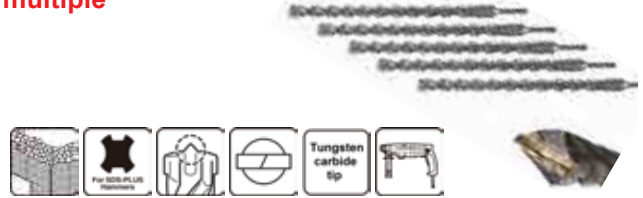

Range	Bit dia mm	Length mm	Working Length mm	Sales Pkg Qty	Part No.
	4	110	50	5	B-60224
	5	110	50	5	B-60230
	5	160	100	5	B-60246
	5.5	110	50	5	B-60252
	5.5	160	100	5	B-60268
	6	110	50	5	B-60274
	6	160	100	5	B-60280
	6	160	100	10	B-59271
	6	210	150	5	B-61597
	6	210	150	10	B-59287
	6.5	110	50	5	B-60296
	6.5	160	100	5	B-60305
	6.5	160	100	10	B-59293
	6.5	160	100	25	B-59318
★★★★☆	6.5	210	150	5	B-61606
	6.5	210	150	10	B-59302
	6.5	210	150	25	B-59324
	7	110	50	5	B-60311
	7	160	100	5	B-60327
	8	110	50	5	B-60333
	8	160	100	5	B-60349
	9	160	100	5	B-60355
	10	110	50	5	B-60361
	10	160	100	5	B-60377
	12	160	100	5	B-60383
	13	160	100	5	B-61612
	14	160	100	5	B-61628
	14	210	150	5	B-61634
	17	210	150	5	B-61640

TCT drill bit for SDS-PLUS hammers Centering tip assortment in plastic case



Range	Size mm	Sales Pkg Qty	Part No.
★★★★☆	5x110, 6x110, 6x160, 8x110, 8x160	5	B-54710
	5.0x160, 5.5x160, 6.0x160, 6.5x160, 8.0x160	5	B-57021
	5.5x160, 6.0x160, 6.5x160, 8.0x160, 10x160	5	B-57037
	6x110, 6x110, 8x160, 8x160, 10x160	5	B-55784
	6x110, 8x160, 8x160, 10x160, 10x160	5	B-54704
	5x110, 6x160, 8x160, 10x160	4x12set	E-13596-12
	6x160, 8x160, 10x160, 12x160	4x12set	E-13605-12
	B-54710x5sets, B-55784x5sets	5x10sets	B-56421
	4x110, 5x110, 6x160, 8x160, 10x160	5x12set	E-15718-12
	5x110, 6x110, 6x160, 8x160, 10x160	5x12set	E-15702-12
	5x110, 6x160, 8x160, 10x160, 12x160	5x12set	E-15724-12
	Drill 6 to 12, Bull point 140, Cold chisel 20x140	6x12set	E-15746-12
	5x110, 6x110, 8x110, 6x160, 8x160, 10x160	6x12set	E-15730-12

TCT drill bit for SDS-PLUS hammers V-PLUS

V-PLUS



Range	Bit dia mm	Length mm	Working Length mm	Sales Pkg Qty	Part No.
★★★★☆	3.5	110	50	1	E-10665
	4	110	50	1	B-47232
	4	160	100	1	B-47248
	4.5	160	100	1	E-10671
	5	110	50	1	B-46492
	5	140	80	1	B-47254
	5	160	100	1	B-46501
	5	210	150	1	B-47260
	5	260	200	1	B-47276
	5	310	250	1	B-47282
	5	450	390	1	B-60408
	5.5	110	50	1	B-47298
	5.5	160	100	1	B-47307
	5.5	210	150	1	B-47313
	5.5	260	200	1	B-47329
	5.5	310	250	1	B-47335
	6	110	50	1	B-46517
	6	160	100	1	B-46523
	6	210	150	1	B-47341
	6	260	200	1	B-47357
	6	310	250	1	B-47363
	6	460	400	1	B-47379
	6.5	110	50	1	B-47385
	6.5	160	100	1	B-47391
	6.5	210	150	1	B-47400
	6.5	260	200	1	B-47416
	6.5	310	250	1	B-47422
	7	110	50	1	B-47438
	7	160	100	1	B-47444
	7	210	150	1	B-47450
	7	250	190	1	B-47466
	8	110	50	1	B-46539
	8	160	100	1	B-46545
	8	210	150	1	B-47472
	8	260	200	1	B-47488
	8	310	250	1	B-47494
	8	400	340	1	B-47503
	8	460	400	1	B-47519
	8	600	540	1	B-47525
	9	160	100	1	B-47531

Range	Bit dia mm	Length mm	Working Length mm	Sales Pkg Qty	Part No.
★★★★☆	9	210	150	1	B-47547
	9.5	160	100	1	B-47553
	9.5	310	250	1	B-51409
	10	110	50	1	B-46551
	10	160	100	1	B-46567
	10	210	150	1	B-47569
	10	260	200	1	B-47575
	10	310	250	1	B-47581
	10	350	290	1	B-47597
	10	450	390	1	B-47606
	10	600	540	1	B-47612
	10	800	740	1	B-47628
	10	1000	940	1	B-47634
	11	160	110	1	B-47640
	11	210	160	1	B-47656
	11	260	210	1	B-47662
	11	310	260	1	B-47678
	12	160	110	1	B-46573
	12	210	160	1	B-47684
	12	260	210	1	B-47690
	12	310	260	1	B-47709
	12	360	310	1	B-47715
	12	450	400	1	B-47721
	12	600	550	1	B-47737
	12	800	750	1	B-47743
	12	1000	950	1	B-47759
	13	160	110	1	B-47765
	13	210	160	1	B-47771
	13	260	210	1	B-47787
	13	310	260	1	B-47793
	14	160	110	1	B-46589
	14	210	160	1	B-47802
	14	260	210	1	B-47818
	14	310	260	1	B-47824
	14	450	400	1	B-47830
	14	600	550	1	B-47846
	14	1000	950	1	B-47852
	15	160	110	1	B-47868
	15	210	160	1	B-47874
	15	260	210	1	B-47880
	15	450	400	1	B-47896
	16	160	110	1	B-47905
	16	210	160	1	B-47911
	16	260	210	1	B-47927
	16	310	260	1	B-47933
	16	450	400	1	B-47949
	16	600	550	1	B-47955
	16	800	750	1	B-47961
	16	1000	950	1	B-47977
	17	210	160	1	B-47983
	17	450	400	1	B-47999
	18	200	150	1	B-48000
	18	300	250	1	B-48016
	18	450	400	1	B-48022
	18	600	550	1	B-48038
18	1000	950	1	B-48044	
19	200	150	1	B-48050	
19	450	400	1	B-48066	
20	200	150	1	B-48072	
20	300	250	1	B-48088	
20	450	400	1	B-48094	
20	600	550	1	B-48103	
20	800	750	1	B-48119	
20	1000	950	1	B-48125	
22	250	200	1	B-48131	
22	450	400	1	B-48147	
22	600	550	1	B-48153	
22	1000	950	1	B-48169	
23	250	200	1	B-48175	
23	450	400	1	B-48181	
24	250	200	1	B-48197	
24	450	400	1	B-48206	
24	600	550	1	B-48212	
25	250	200	1	B-48228	
25	450	400	1	B-48234	
25	600	550	1	B-48240	
25	1000	950	1	B-48256	
26	250	200	1	B-48262	
26	450	400	1	B-48278	

TCT drill bit for SDS-PLUS hammers V-PLUS multiple

V-PLUS



Range	Bit dia mm	Length mm	Working Length mm	Sales Pkg Qty	Part No.
	5	110	50	5	B-46492-5
	5	110	50	10	B-46492-10
	5	110	50	25	B-46492-25
	5	110	50	50	B-46492-50
	5	160	100	10	B-46501-10
	5	160	100	25	B-46501-25
	5	160	100	50	B-46501-50
	5.5	110	50	5	B-47298-5
	6	110	50	5	B-46517-5
	6	110	50	10	B-46517-10
	6	110	50	50	B-46517-50
	6	160	100	5	B-46523-5
	6	160	100	10	B-46523-10
	6	160	100	25	B-46523-25
	6	160	100	50	B-46523-50
	6	210	150	5	B-47341-5
	6	210	150	10	B-47341-10
	6	210	150	25	B-47341-25
	6	210	150	50	B-47341-50
	6.5	110	50	5	B-47385-5
	6.5	160	100	5	B-47391-5
	6.5	210	150	25	B-47400-25
	6.5	260	200	25	B-47416-25
	8	110	50	5	B-46539-5
	8	110	50	10	B-46539-10
	8	110	50	50	B-46539-50
★★★★☆	8	160	100	5	B-46545-5
	8	160	100	10	B-46545-10
	8	160	100	25	B-46545-25
	8	160	100	50	B-46545-50
	8	210	150	5	B-47472-5
	8	210	150	10	B-47472-10
	8	210	150	25	B-47472-25
	8	210	150	50	B-47472-50
	8	260	200	25	B-47488-25
	8	310	250	25	B-47494-25
	10	110	50	10	B-46551-10
	10	110	50	50	B-46551-50
	10	160	100	5	B-46567-5
	10	160	100	10	B-46567-10
	10	160	100	25	B-46567-25
	10	160	100	50	B-46567-50
	10	210	150	5	B-47569-5
	10	210	150	10	B-47569-10
	10	210	150	25	B-47569-25
	10	210	150	50	B-47569-50
	10	260	200	25	B-47575-25
	12	160	110	5	B-46573-5
	12	160	110	10	B-46573-10
	12	160	110	25	B-46573-25
	12	210	160	5	B-47684-5
	12	210	160	10	B-47684-10
	12	210	160	25	B-47684-25

TCT drill bit for SDS-PLUS hammers V-PLUS assortment in plastic case

V-PLUS



Range	Size mm	Sales Pkg Qty	Part No.
	5x110, 6x110, 8x110, 6x160, 8x160	5	B-49052
	5x110, 6x110, 6x160, 8x160, 10x160	5	B-49133
	5x110, 6x160, 8x160, 10x160, 12x160	5	B-49074
★★★★☆	5x110, 6x110, 6x160, 8x110, 8x160, 10x160, 12x160	7	B-49046
	5x110, 6x110, 6x160, 8x160, 10x160, 10x210, 12x210	10	B-49127
	5x110, 6x160, 8x160	12	B-49111
	6x160, 8x160, 10x160, 12x160	12	B-49105
	5x110, 6x160, 8x160, 10x160, 12x160	12	B-49096
	6x110, 6x160, 8x160, 10x160, 12x160, 14x160, 16x160	12	B-49080

TCT drill bit for SDS-PLUS hammers 4cutter



Range	Bit dia mm	Length mm	Working Length mm	Sales Pkg Qty	Part No.
	5	110	50	1	B-68127
	5	160	100	1	B-68133
	5	210	150	1	B-68149
	5	260	200	1	B-68155
	6	110	50	1	B-62496
	6	160	100	1	B-62505
	6	210	150	1	B-62511
	6	260	200	1	B-62527
	6	310	250	1	B-68161
	6.5	110	50	1	B-62533
	6.5	160	100	1	B-62549
	6.5	210	150	1	B-62555
	6.5	260	200	1	B-62561
	7	110	50	1	B-62577
	7	160	100	1	B-62583
	7	210	150	1	B-62599
	8	110	50	1	B-62608
	8	160	100	1	B-62614
★★★★☆	8	210	150	1	B-62620
	8	260	200	1	B-62636
	8	310	250	1	B-62642
	8	460	400	1	B-62658
	10	110	50	1	B-62664
	10	160	100	1	B-62670
	10	210	150	1	B-62686
	10	260	200	1	B-62692
	10	310	250	1	B-62701
	10	350	290	1	B-62717
	10	460	400	1	B-62723
	12	160	100	1	B-62739
	12	210	150	1	B-62745
	12	260	200	1	B-62751
	12	310	250	1	B-62767
	12	350	290	1	B-62773
	12	460	400	1	B-62789
	14	160	100	1	B-62795
	14	210	150	1	B-62804

Range	Bit dia mm	Length mm	Working Length mm	Sales Pkg Qty	Part No.
★★★★☆	14	260	200	1	B-62810
	14	310	250	1	B-62826
	14	350	290	1	B-62832
	14	460	400	1	B-62848
	16	160	100	1	B-62854
	16	210	150	1	B-62860
	16	260	200	1	B-62876
	16	310	250	1	B-62882
	16	350	290	1	B-62898
	16	460	400	1	B-62907
	18	260	200	1	B-68177
	18	460	400	1	B-68236
	20	260	200	1	B-68183
	20	460	400	1	B-68242
	22	260	200	1	B-68199
	22	460	400	1	B-68258
	25	260	200	1	B-68208
	25	460	400	1	B-68264



TCT drill bit for SDS-PLUS hammers 4cutter assortment in plastic case



Range	Size mm	Sales Pkg Qty	Part No.
★★★★☆	5x110, 6x160, 8x160, 10x160	4	E-14249

	Hole	Tungsten carbide tip

Solid TCT (5 - 16mm)

Three piece TCT (18 - 32mm)

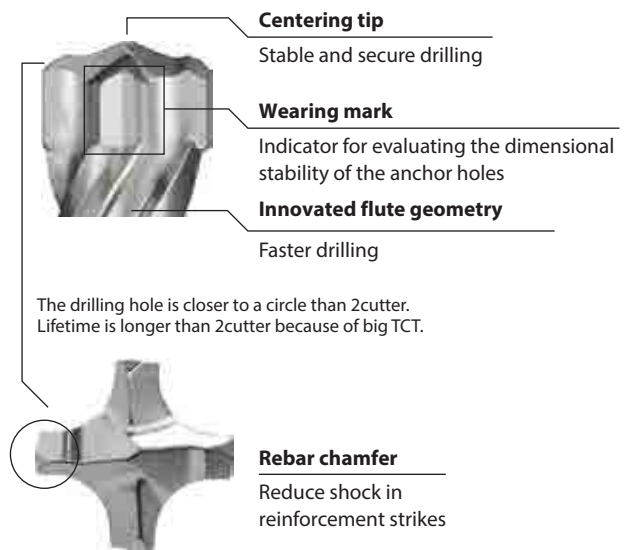

TCT drill bit for SDS-PLUS hammers Nemesis II



Range	Bit dia mm	Length mm	Working Length mm	Sales Pkg Qty	Part No.
★★★★★	5	115	50	1	B-57897
	5	165	100	1	B-57906
	5	215	150	1	B-57912
	5	265	200	1	B-57928
	5	315	250	1	B-57934

Range	Bit dia mm	Length mm	Working Length mm	Sales Pkg Qty	Part No.
★★★★★	5.5	115	50	1	B-57940
	5.5	165	100	1	B-57956
	6	115	50	1	B-57962
	6	165	100	1	B-57978
	6	215	150	1	B-57984
	6	265	200	1	B-57990
	6	315	250	1	B-58001
	6.5	165	100	1	B-58023
	6.5	215	150	1	B-58039
	6.5	265	200	1	B-58045
	6.5	315	250	1	B-58051
	7	115	50	1	B-58067
	7	165	100	1	B-58073
	7	215	150	1	B-58089
	8	115	50	1	B-58095
	8	165	100	1	B-58104
	8	215	150	1	B-58110
	8	265	200	1	B-58126
	8	315	250	1	B-58132
	8	465	400	1	B-58154
	9	165	100	1	B-58176
	9	265	200	1	B-58182
	10	115	50	1	B-58198
	10	165	100	1	B-58207
	10	215	150	1	B-58213
	10	265	200	1	B-58229
	10	315	250	1	B-58235
	10	455	390	1	B-58257
	10	600	540	1	B-58263
	10	1000	940	1	B-58279
	11	165	100	1	E-14495
	11	215	150	1	E-14504
	11	265	200	1	E-14510
	11	315	250	1	E-14526
	12	165	100	1	E-14532
	12	215	150	1	E-14548
	12	265	200	1	E-14554
	12	315	250	1	E-14560
	12	455	390	1	E-14576
	12	600	550	1	E-14582
	12	1,000	950	1	E-19598
	13	165	100	1	E-14598
	13	215	150	1	E-14607
	13	265	200	1	E-14613
	13	315	250	1	E-14629
	14	165	100	1	E-14635
	14	215	150	1	E-14641
	14	265	200	1	E-14657
	14	315	250	1	E-14663
	14	455	390	1	E-14679
14	600	550	1	E-14685	
14	1,000	950	1	E-19607	
15	165	100	1	E-14691	
15	215	150	1	E-14700	
15	265	200	1	E-14716	
15	455	390	1	E-14722	
16	165	100	1	E-14738	
16	215	150	1	E-14744	
16	265	200	1	E-14750	
16	315	250	1	E-14766	
16	455	390	1	E-14772	
16	600	550	1	E-14788	
16	1,000	950	1	E-19613	
18	250	200	1	B-58615	
18	450	400	1	B-58621	
20	250	200	1	B-58637	
20	450	400	1	B-58659	
22	250	200	1	B-58665	
22	450	400	1	B-58687	
24	250	200	1	B-58693	
24	450	400	1	B-58702	
25	250	200	1	B-58718	
25	450	400	1	B-58724	
28	250	200	1	B-58746	
28	450	400	1	B-58752	
30	250	200	1	B-58768	
30	450	400	1	B-58774	
32	450	400	1	B-58780	

TCT drill bit for SDS-PLUS hammers Nemesis II multiple

NEMESIS II



Range	Bit dia mm	Length mm	Working Length mm	Sales Pkg Qty	Part No.
★★★★★	5	115	50	5	B-58796
	5	115	50	10	B-63214
	5	165	100	10	B-63220
	5.5	115	50	5	B-58805
	5.5	115	50	10	B-63236
	5.5	165	100	10	B-63242
	6	115	50	5	B-58811
	6	115	50	10	B-63258
	6	165	100	5	B-58827
	6	165	100	10	B-63264
	6	215	150	5	B-58833
	6	215	150	10	B-63270
	6	265	200	10	B-63286
	6	315	250	10	B-63292
	6.5	165	100	5	B-58849
	6.5	165	100	10	B-63301
	6.5	215	150	10	B-63317
	6.5	265	200	10	B-63323
	6.5	315	250	10	B-63339
	7	115	50	10	B-63345
	7	165	100	10	B-63351
	8	115	50	5	B-58883
	8	115	50	10	B-63367
	8	165	100	5	B-58899
	8	165	100	10	B-63373
	8	215	150	5	B-58908
	8	215	150	10	B-63389
	8	265	200	10	B-63395
	10	115	50	10	B-63404
	10	165	100	5	B-58914
	10	165	100	10	B-63410
	10	215	150	5	B-58920
	10	215	150	10	B-63426
	10	265	200	10	B-63432
	10	315	250	10	B-63448
	12	165	100	5	E-14794
	12	165	100	10	E-14825
	12	215	150	5	E-14803
	12	215	150	10	E-14831
	12	265	200	5	E-14819
	12	265	200	10	E-14847
	12	310	250	10	E-14853
	14	165	100	10	E-14869
	14	215	150	10	E-14875
	14	265	200	10	E-14881
	14	315	250	10	E-14897

TCT drill bit for SDS-PLUS hammers Nemesis II assortment in plastic case

NEMESIS II



Range	Size mm	Sales Pkg Qty	Part No.
★★★★★	6.5x165, 8x165, 10x165	3	B-59097
	5x115, 6x115, 8x115	3	B-58986
	6.5x165, 8x165, 10x165	3	B-59097
	5.5x115, 7x115, 6x165, 7x165, 8x165	5	B-59003
	5.5x115, 5.5x165, 6x115, 6.5x165, 7x165, 8x165, 10x165	7	B-59053
	5, 6, 6.5, 6.5, 8, 10, 12	7	E-14906
	5, 6, 8, 10, 12	7	E-14928
5, 6, 8, 10, 12	12	E-14912	

TCT drill bit for SDS-PLUS hammers Dustless



Range	Bit dia mm	Length mm	Working Length mm	Sales Pkg Qty	Part No.
Specialized	12	330	200	1	B-64381
	14	360	240	1	B-64397
	16	360	240	1	B-64406
	18	360	240	1	B-64412

TCT drill bit for SDS-MAX hammers



Range	Bit dia mm	Length mm	Working Length mm	Sales Pkg Qty	Part No.
★★★★★	12	340	200	1	D-33875
	12	540	400	1	D-33881
	12.7	340	200	1	D-54994
	14	340	200	1	D-33897
	14	540	400	1	D-33906
	14.3	340	200	1	D-55011
	15	340	200	1	D-33912
	15	540	400	1	D-33928
	16	340	200	1	D-33934
	16	540	400	1	D-33940
	18	340	200	1	D-33956
	18	540	400	1	D-33962
	19	340	200	1	D-55033
	19	540	400	1	D-55055
	20	340	200	1	D-33978
	20	540	400	1	D-33984
	22	340	200	1	D-33990
	22	540	400	1	D-34001
	24	340	200	1	D-34017
	24	540	400	1	D-34023
	25	340	200	1	D-34039
	25	540	400	1	D-34045
	28	370	250	1	D-34051
	28	570	450	1	D-34067
	30	370	250	1	D-34073
	30	570	450	1	D-34089
	32	370	250	1	D-34095
	32	570	450	1	D-34104
	35	370	250	1	D-34110
	35	570	450	1	D-34126
	38	370	250	1	D-34132
	38	570	450	1	D-34148
	40	370	250	1	D-34154
	40	570	450	1	D-34160

TCT drill bit for SDS-MAX hammers assortment in plastic case



Range	Size mm	Sales Pkg Qty	Part No.
★★★★★	16x340, 18x340, 20x340	3	D-40587

TCT drill bit for SDS-MAX hammers 4cutter

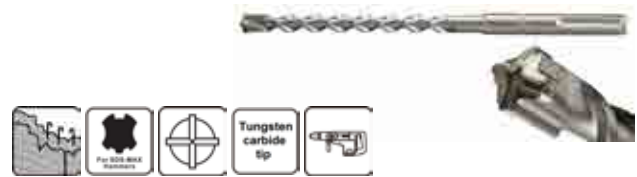

Range	Bit dia mm	Length mm	Working Length mm	Sales Pkg Qty	Part No.
★★★★★	12	340	200	1	E-11324
	12	540	400	1	E-11330
	14	340	200	1	E-11346
	14	540	400	1	E-11352
	16	340	200	1	E-11368
	16	540	400	1	E-11374
	18	340	200	1	E-11380
	18	540	400	1	E-11396
	20	340	220	1	E-11405
	20	540	420	1	E-11411
	22	340	220	1	E-11427
	22	540	420	1	E-11433
	24	340	220	1	E-11449
	24	540	420	1	E-11455
	25	340	220	1	E-11461
	25	540	420	1	E-11477
	28	370	250	1	E-11483
	28	570	450	1	E-11499
	30	370	250	1	E-11508
	30	570	450	1	E-11514

TCT drill bit for SDS-MAX hammers Nemesis



Range	Bit dia mm	Length mm	Working Length mm	Sales Pkg Qty	Part No.
★★★★★	12	340	200	1	B-19897
	12	540	400	1	B-19906
	12	740	600	1	B-19912
	14	340	200	1	B-19928
	14	540	400	1	B-19934
	15	340	200	1	B-19940
	15	540	400	1	B-19956
	16	340	200	1	B-19962
	16	540	400	1	B-19978
	16	940	800	1	B-19984
	18	340	200	1	B-19990
	18	540	400	1	B-20002
	18	940	800	1	B-20018
	20	320	200	1	B-20024
	20	520	400	1	B-20030
	20	920	800	1	B-20046
	22	320	200	1	B-20052
	22	520	400	1	B-20068
	22	920	800	1	B-20074
	24	320	200	1	B-20080
	24	520	400	1	B-20096
	25	320	200	1	B-20105
	25	520	400	1	B-20111
	25	920	800	1	B-20127
	26	520	400	1	B-20133
	28	370	250	1	B-20149
	28	570	450	1	B-20155
	28	670	550	1	B-20161
	28	920	800	1	B-20177
	30	370	250	1	B-20183
	30	570	450	1	B-20199
	32	370	250	1	B-20208
	32	570	450	1	B-20214
	32	920	800	1	B-20220
	35	370	250	1	B-20236
	35	570	450	1	B-20242

Range	Bit dia mm	Length mm	Working Length mm	Sales Pkg Qty	Part No.
★★★★☆	35	670	550	1	B-20258
	35	920	800	1	B-20264
	38	370	250	1	B-20270
	38	570	450	1	B-20286
	40	370	250	1	B-20292
	40	570	450	1	B-20301
	40	920	800	1	B-20317
	45	570	450	1	B-20323
	50	570	450	1	B-42896
	52	570	450	1	B-20339

TCT drill bit for SDS-MAX hammers Mining



Range	Bit dia mm	Length mm	Working Length mm	Sales Pkg Qty	Part No.
Specialized	28	670	550	1	B-15039
	28	920	800	1	B-18035
	28	1320	1200	1	B-18041
	30	720	600	1	B-19847
	30	920	800	1	B-19853
	32	570	450	1	B-14613
	32	920	800	1	B-15045
	32	1320	1200	1	B-18057
	40	370	250	1	B-18079

TCT drill bit for SDS-MAX hammers Mining 2



Range	Bit dia mm	Length mm	Working Length mm	Sales Pkg Qty	Part No.
Specialized	28	670	550	1	B-39431
	30	720	600	1	B-39447
	32	570	450	1	B-39453
	32	920	800	1	B-39469

TCT drill bit for SDS-MAX hammers Dustless



Range	Bit dia mm	Length mm	Working Length mm	Sales Pkg Qty	Part No.
Specialized	16	600	400	1	B-64428
	18	600	400	1	B-64434
	20	600	400	1	B-64440
	22	600	400	1	B-64456
	24	600	400	1	B-64462
	25	600	400	1	B-64478
	28	600	400	1	B-64484
	30	600	400	1	B-64509
	32	600	400	1	B-64521
	35	600	400	1	B-64543









TCT drill bit for 17mm Hex shank hammers



Range	Bit dia mm	Length mm	Sales Pkg Qty	Part No.
★★★★☆	16	280	1	D-20127
	16	505	1	D-20133
	18	280	1	D-20149
	18	505	1	D-20155
	19	280	1	D-20161
	19	505	1	D-20177
	20	280	1	D-20183
	20	505	1	D-20199
	22	280	1	D-20208
	22	505	1	D-20214
	25.5	280	1	D-20220
	25.5	505	1	D-20236
	28	280	1	D-20242
	28	505	1	D-20258
	32	280	1	D-20264
	32	505	1	D-20270
	35	280	1	D-20286
	35	505	1	D-20292

Chisels



Shape	Application	For SDS-PLUS Hammers	For SDS-MAX Hammers	17mm Hex	19mm Hex	21mm Hex	28.6mm Hex	30mm Hex	Makita Small
 <p>Bull point</p>	Demolition and adjustment work in masonry and concrete. Chipping and breaking in masonry and concrete. Starts holes in concrete	•	•	•	•	•	•	•	•
 <p>Cold chisel</p>	Adjustment work in masonry and concrete. Chipping, breaking, edging and channeling in masonry and concrete.	•	•	•	•	•	•	•	
 <p>Grooving chisel</p>	Cutting channels in concrete.	•	•	•					
 <p>Scaling chisel</p>	Removing concrete residues.	•	•	•	•	•	•	•	•
 <p>Clay spade</p>	Digging in clay, hard gravel, hard packed gravel, soil and dirt.		•	•		•		•	
 <p>Rammer</p>	Tamping asphalt and compacting gravel, soil and dirt.		•	•	•	•		•	
 <p>Bushing tool</p>	Roughing concrete and asphalt up.		•	•		•			
 <p>Scraper</p>	Scraping floor tiles, linoleum floor and clean-up.	•							•

Core bit for SDS-PLUS hammers



Range	Bit dia mm	Length mm	Working Length mm	Note	Sales Pkg Qty	Part No.
★★★★☆	8	110	60	Pilot drill	1	D-73972
	30	72	50	Core only	1	D-73891
	35	72	50	Core only	1	D-73900
	40	72	50	Core only	1	D-73916
	50	72	50	Core only	1	D-73922
	68	72	50	Core only	1	D-73938
	82	72	50	Core only	1	D-73944
	90	72	50	Core only	1	D-73950
	100	72	50	Core only	1	D-73966
	68	175	50	Core,Adapter, Pilot drill set	1	D-74011
	82	175	50	Core,Adapter, Pilot drill set	1	D-74027
	-	110	-	SDS-PLUS shank adapter	1	D-73988
	-	200	-		1	D-73994
	-	350	-		1	D-74005

Concrete core cutter for SDS-MAX hammers



Range	Bit dia mm	Length mm	Sales Pkg Qty	Part No.
★★★★☆	40	550	1	B-57629
	45	550	1	B-57635
	45	990	1	B-57641
	55	550	1	B-57657
	55	990	1	B-57663
	65	550	1	B-57679
	65	990	1	B-57685
	80	550	1	B-57691
	80	990	1	B-57700

Bull point for SDS-PLUS hammers



Range	Size mm	Sales Pkg Qty	Part No.
★★★★☆	250	1	B-64294
	140	1	D-19152
	160	1	D-08034
★★★★☆	230	1	D-71249
	250	1	D-08713
	250	1	D-62424
	400	1	D-19015

Bull point for SDS-PLUS hammers Premium



Range	Size mm	Sales Pkg Qty	Part No.
★★★★☆	250	1	B-64238

Bull point for SDS-PLUS hammers Self-sharpening

Self sharpening



Range	Size mm	Sales Pkg Qty	Part No.
★★★★☆	250	1	B-64761

Feature

Unique star-shape design keeps always sharp

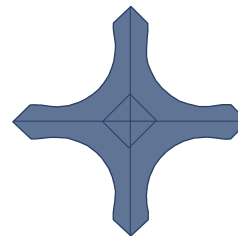
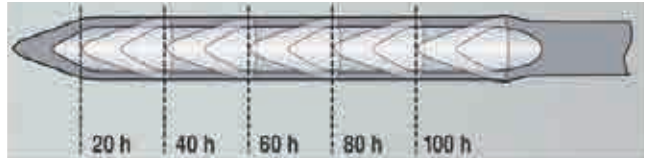

Benefit

No re-sharpening necessary
No work interruption due to resharping
No service costs

Cold chisel for SDS-PLUS hammers



Range	Size mm	Sales Pkg Qty	Part No.
★★★★☆	20x250	1	B-64303
	20x140	1	D-19168
	20x160	1	D-71255
	20x230	1	D-71261
	20x250	1	D-08729
	20x250	1	D-62430
	20x400	1	D-19021

Cold chisel for SDS-PLUS hammers Premium



Range	Size mm	Sales Pkg Qty	Part No.
★★★★☆	20x250	1	B-64244

Cold chisel for SDS-PLUS hammers Self-sharpening

Self sharpening



Range	Size mm	Sales Pkg Qty	Part No.
★★★★☆	20x250	1	B-64777

Scaling chisel for SDS-PLUS hammers



Range	Size mm	Sales Pkg Qty	Part No.
★★★★☆	40x250	1	B-64319
★★★★☆	40x230	1	D-71277
	40x250	1	D-08735
	50x215	1	D-25616
	50x215	1	D-62446
	80x150	1	D-61042
	80x250	1	D-61020

Scaling chisel for SDS-PLUS hammers Premium



Range	Size mm	Sales Pkg Qty	Part No.
★★★★☆	40x250	1	B-64250

Scaling chisel for SDS-PLUS hammers Self-sharpening

Self sharpening



Range	Size mm	Sales Pkg Qty	Part No.
★★★★☆	40x250	1	B-14059
	60x250	1	B-14065

Scaling chisel for SDS-PLUS hammers Tile



Range	Size mm	Sales Pkg Qty	Part No.
★★★★☆	40x260	1	B-14071

Grooving chisel for SDS-PLUS hammers



Range	Size mm	Sales Pkg Qty	Part No.
★★★★☆	8x170	1	A-30075

Scraper Assembly for SDS-PLUS hammers



Range	Size mm	Sales Pkg Qty	Part No.
Specialized	100x160	1	A-68161

Chisel for SDS-PLUS hammers assortment in plastic case



Range	Size mm	Sales Pkg Qty	Part No.
★★★★☆	Bull point 230, Cold chisel 20x230, Scaling chisel 40x230	3	D-71314
	Bull point 250, Cold chisel 20x250, Scaling chisel 40x250	3	D-30134

Chisel for SDS-PLUS hammers assortment in aluminum case



Range	Size mm	Sales Pkg Qty	Part No.
★★★★☆	Bull point 250, Cold chisel 20x250, Scaling chisel 40x250	3	D-05181
	Bull point 250, Cold chisel 20x250	4	D-08757
	Bull point 250, Cold chisel 20x250, Scaling chisel 40x250	5	D-16368

Chisel for SDS-PLUS hammers assortment in aluminum case with Makita blue



Range	Size mm	Sales Pkg Qty	Part No.
★★★★☆	Bull point 250, Cold chisel 20x250, Scaling chisel 40x250	3	D-42357
	Bull point 250, Cold chisel 20x250	4	D-42363
	Bull point 250, Cold chisel 20x250, Scaling chisel 40x250	5	D-42379

Chisel for SDS-PLUS hammers Premium assortment in plastic case



Range	Size mm	Sales Pkg Qty	Part No.
★★★★☆	Bull point 250, Cold chisel 20x250, Scaling chisel 40x250	3	E-04911

Chisel for SDS-PLUS hammers Self-sharpening assortment in plastic case



Range	Size mm	Sales Pkg Qty	Part No.
★★★★☆	Bull point 250, Cold chisel 20x250, Scaling chisel 40x250	5	E-13188

Bull point for SDS-MAX hammers



Range	Size mm	Sales Pkg Qty	Part No.
★★★★☆	280	1	A-80787
	280	1	B-13823
	400	1	A-80793
	400	1	B-13839
	400	1	B-64325
	600	1	B-13845
★★★★☆	300	1	D-34176
	400	1	D-34182
	400	10	D-34182-10
	600	1	D-34198

Bull point for SDS-MAX hammers Premium



Range	Size mm	Sales Pkg Qty	Part No.
★★★★☆	400	1	B-64266

Bull point for SDS-MAX hammers Self-sharpening

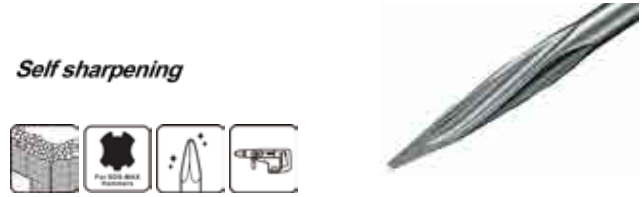

Range	Size mm	Sales Pkg Qty	Part No.
★★★★☆	400	1	B-23064
	400	1	E-13172

Cold chisel for SDS-MAX hammers



Range	Size mm	Sales Pkg Qty	Part No.
★★★★☆	25x280	1	A-80802
	25x280	1	B-13851
	25x400	1	A-80818
	25x400	1	B-13867
	25x400	1	B-64331
	25x600	1	B-13873
★★★★☆	25x300	1	D-34207
	25x400	1	D-34213
	25x400	10	D-34213-10
	25x600	1	D-34229

Cold chisel for SDS-MAX hammers Premium



Range	Size mm	Sales Pkg Qty	Part No.
★★★★☆	25x400	1	B-64272

Cold chisel for SDS-MAX hammers Self-sharpening



Range	Size mm	Sales Pkg Qty	Part No.
★★★★☆	25x400	1	B-64783

Scaling chisel for SDS-MAX hammers



Range	Size mm	Sales Pkg Qty	Part No.
★★★★☆	50x400	1	A-80824
	50x400	1	B-13889
	50x400	1	B-64347
	80x300	1	B-13895
	115x350	1	B-13910
★★★☆☆	50x400	1	D-34235
	80x300	1	D-34241

Scaling chisel for SDS-MAX hammers Premium



Range	Size mm	Sales Pkg Qty	Part No.
★★★★☆	50x380	1	B-64288

Scaling chisel for SDS-MAX hammers Self-sharpening

Self sharpening



Range	Size mm	Sales Pkg Qty	Part No.
★★★★☆	50x350	1	B-14015

Scaling chisel for SDS-MAX hammers Tile



Range	Size mm	Sales Pkg Qty	Part No.
★★★★☆	50x300	1	A-80830
	50x300	1	B-14021

Grooving chisel for SDS-MAX hammers



Range	Size mm	Sales Pkg Qty	Part No.
Specialized	26x300	1	B-13926

Clay spade for SDS-MAX hammers



Range	Size mm	Sales Pkg Qty	Part No.
Specialized	110x400	1	B-13976

Rammer for SDS-MAX hammers



Range	Size mm	Note	Sales Pkg Qty	Part No.
Specialized	140	Without adapter. Use with adapter(A-19897)	1	A-19875

Bushing tool for SDS-MAX hammers



Range	Size mm	Note	Sales Pkg Qty	Part No.
Specialized	60x60	Without adapter. Use with adapter(A-19897)	1	A-19881

Ground rod adapter for SDS-MAX hammers



Range	Size mm	Sales Pkg Qty	Part No.
Specialized	13.3x260	1	E-13029
	16.5x260	1	E-13035
	22.2x260	1	E-13041

Shank adapter for SDS-MAX hammers



Range	Size mm	Note	Sales Pkg Qty	Part No.
Specialized	250	Shank for A-19881, A-19875	1	A-19897

Chisel for SDS-MAX hammers assortment in cardboard box



Range	Size mm	Sales Pkg Qty	Part No.
★★★★☆	Bull point 400, Cold chisel 25x400	10	D-35324-10

Chisel for SDS-MAX hammers assortment in aluminum case



Range	Size mm	Sales Pkg Qty	Part No.
★★★★☆	Bull point 400, Cold chisel 25x400, Scaling chisel 50x400	3	D-40543
	Bull point 300, 400, Cold chisel 25x300, 25x400	4	D-40559
	Bull point 400, Cold chisel 25x400	5	D-40618
	Bull point 400, Cold chisel 25x400, Scaling chisel 50x400, 80x300	6	D-40565

Chisel for SDS-MAX hammers assortment in aluminum case with Makita blue



Range	Size mm	Sales Pkg Qty	Part No.
★★★★☆	Bull point 400, Cold chisel 25x400, Scaling chisel 50x400	3	D-42450
	Bull point 300, 400, Cold chisel 25x400, 25x300	4	D-42466
	Bull point 400, Cold chisel 25x400	5	D-42472
	Bull point 400, Cold chisel 25x400, Scaling chisel 50x400, 80x300	6	D-42488

Chisel for SDS-MAX hammers Premium assortment in plastic case



Range	Size mm	Sales Pkg Qty	Part No.
★★★★☆	Bull point 400, Cold chisel 25x400, Scaling chisel 50x380	5	E-04927

Chisel for SDS-MAX hammers Self-sharpening assortment in plastic case

Self sharpening



Range	Size mm	Sales Pkg Qty	Part No.
★★★★☆	Bull point 400, Cold chisel 25x400, Scaling chisel 50x350	5	E-13194

Bull point for 17mm Hex shank hammers



Range	Size mm	Sales Pkg Qty	Part No.
★★★★☆	280	1	A-80450
	450	1	A-80547
★★★★☆	210	1	D-16374
	255	1	D-71283
	280	1	D-08682
	280	1	D-26303
	350	1	D-29860
	450	1	D-16863

Cold chisel for 17mm Hex shank hammers



Range	Size mm	Sales Pkg Qty	Part No.
★★★★☆	19x280	1	A-80569
	19x450	1	A-80575
	19x210	1	D-26587
★★★☆☆	19x280	1	D-08707
	19x450	1	D-16879
	22x255	1	D-71299

Scaling chisel for 17mm Hex shank hammers



Range	Size mm	Sales Pkg Qty	Part No.
★★★★☆	50x280	1	A-80606
	40x255	1	D-71308
★★★☆☆	50x280	1	D-20694
	50x450	1	D-52548

Grooving chisel for 17mm Hex shank hammers



Range	Size mm	Sales Pkg Qty	Part No.
★★★★☆	22x280	1	A-48555
	26x280	1	A-48561

Clay spade for 17mm Hex shank hammers



Range	Size mm	Sales Pkg Qty	Part No.
Specialized	105x400	1	A-25214

Rammer for 17mm Hex shank hammers



Range	Size mm	Sales Pkg Qty	Part No.
Specialized	140	1	A-21428

Bushing tool for 17mm Hex shank hammers



Range	Size mm	Sales Pkg Qty	Part No.
Specialized	60x60	1	A-21484

Ground rod adapter for 17mm Hex shank hammers



Range	Size mm	Sales Pkg Qty	Part No.
Specialized	180	1	A-47276

Chisel for 17mm Hex shank hammers assortment in plastic case



Range	Size mm	Sales Pkg Qty	Part No.
★★★★☆	Bull point 255, Cold chisel 22x255, Scaling chisel 40x255	3	D-71320

Bull point for 19mm Hex shank hammers



Range	Size mm	Sales Pkg Qty	Part No.
★★★★☆	300	1	D-20074
	450	1	D-19196

Cold chisel for 19mm Hex shank hammers



Range	Size mm	Sales Pkg Qty	Part No.
★★★★☆	26x300	1	D-20080
	26x450	1	D-19205

Scaling chisel for 19mm Hex shank hammers



Range	Size mm	Sales Pkg Qty	Part No.
★★★★☆	50x300	1	D-20096

Rammer for 19mm Hex shank hammers



Range	Size mm	Sales Pkg Qty	Part No.
Specialized	140	1	A-21478

Ground rod adapter for 19mm Hex shank hammers



Range	Size mm	Sales Pkg Qty	Part No.
Specialized	20x180	1	798132-2

Bull point for 21mm Hex shank hammers



Range	Size mm	Sales Pkg Qty	Part No.
★★★★☆	450	1	A-80553
	320	1	D-16499
★★★★☆	450	1	D-23824
	600	1	D-30994

Cold chisel for 21mm Hex shank hammers



Range	Size mm	Sales Pkg Qty	Part No.
★★★★☆	26x450	1	A-80581
★★★★☆	26x320	1	D-17588
★★★★☆	26x450	1	D-17594

Scaling chisel for 21mm Hex shank hammers



Range	Size mm	Sales Pkg Qty	Part No.
★★★★☆	70x320	1	D-20672

Clay spade for 21mm Hex shank hammers



Range	Size mm	Sales Pkg Qty	Part No.
Specialized	130x460	1	A-47391

Rammer for 21mm Hex shank hammers



Range	Size mm	Sales Pkg Qty	Part No.
Specialized	140	1	A-21434

Bushing tool for 21mm Hex shank hammers



Range	Size mm	Sales Pkg Qty	Part No.
Specialized	60x60	1	A-21490

Bull point for 28.6mm Hex shank hammers



Range	Size mm	Sales Pkg Qty	Part No.
★★★★☆	350	1	D-65034
	410	1	D-17631
	410	1	D-61531
	520	1	D-17675
	520	1	D-61569

Bull point for 28.6mm Hex shank hammers Self-sharpening

Self sharpening



Range	Size mm	Sales Pkg Qty	Part No.
★★★★☆	400	1	B-10372

Cold chisel for 28.6mm Hex shank hammers



Range	Size mm	Sales Pkg Qty	Part No.
★★★★☆	28x410	1	D-17647
	28x410	1	D-61547
	28x520	1	D-17681
	28x520	1	D-61575
	28x520	1	D-61575

Scaling chisel for 28.6mm Hex shank hammers



Range	Size mm	Sales Pkg Qty	Part No.
★★★★☆	75x410	1	D-29228
	75x410	1	D-61553
	75x520	1	D-20725
	75x520	1	D-61581

Bull point for 30mm Hex shank hammers



Range	Size mm	Sales Pkg Qty	Part No.
★★★★☆	410	1	A-80466
★★★★☆	400	1	D-15285

**Bull point for 30mm Hex shank hammers
Self-sharpening**

Self sharpening



Range	Size mm	Sales Pkg Qty	Part No.
★★★★☆	400	1	B-10388

Cold chisel for 30mm Hex shank hammers



Range	Size mm	Sales Pkg Qty	Part No.
★★★★☆	36x410	1	A-80597
★★★★☆	30x400	1	D-15300

Scaling chisel for 30mm Hex shank hammers



Range	Size mm	Sales Pkg Qty	Part No.
★★★★☆	75x310	1	D-23868
	75x310	1	D-34805

Clay spade for 30mm Hex shank hammers



Range	Size mm	Sales Pkg Qty	Part No.
Specialized	120x500	1	B-10300

Rammer for 30mm Hex shank hammers



Range	Size mm	Sales Pkg Qty	Part No.
Specialized	200	1	A-31485

Bull point for Makita small shank



Range	Size mm	Sales Pkg Qty	Part No.
★★★★☆	220	1	B-06921

Scaling chisel for Makita small shank



Range	Size mm	Sales Pkg Qty	Part No.
★★★★☆	20x220	1	B-07004
	30x150	1	B-07331
	50x150	1	B-07347
	50x220	1	B-07010

Scraper Assembly for Makita small shank



Range	Size mm	Sales Pkg Qty	Part No.
Specialized	100x160	1	A-68155

TCT drill bit & chisel for SDS-PLUS hammers assortment in plastic case



Range	Size mm	Sales Pkg Qty	Part No.
★★★★☆	Drill 5 to 8, Bull point 250, Cold chisel 20x250, Scaling chisel 40x250	6	D-58920
	Drill 5.5 to 15, Bull point 160, Cold chisel 20x140	10	D-44971
	Drill 5 to 16, Bull point 160, Cold chisel 20x140	10	D-46361
	Drill 5 to 16, Bull point 160, Cold chisel 20x140	10	D-57059
	Drill 6 to 18, Bull point 160, Cold chisel 20x140	10	D-41470

TCT drill bit & chisel for SDS-PLUS hammers assortment in aluminum case



Range	Size mm	Sales Pkg Qty	Part No.
★★★★☆	Drill 5.5 to 20, Bull point 250, Cold chisel 20x250	10	D-21191
	Drill 5 to 16, Bull point 250, Cold chisel 20x250	13	D-20111
	Drill 5 to 16, Bull point 250, Cold chisel 20x250	13	D-21185
	Drill 6 to 20, Bull point 250, Cold chisel 20x250	10	D-19174
	Drill 5 to 14, Bull point 140, 250, Cold chisel 20x250, 20x140, Scaling chisel 40x250	17	D-19180
	Drill 5 to 14, Bull point 140, 250, Cold chisel 20x250, 20x140, Scaling chisel 40x250	17	D-21200

TCT drill bit & chisel for SDS-PLUS hammers assortment in aluminum case with Makita blue



Range	Size mm	Sales Pkg Qty	Part No.
★★★★☆	Drill 6 to 16, Bull point 250, Cold chisel 20x250	13	B-64674
	Drill 5 to 14, Bull point 140, 250, Cold chisel 20x140, 20x250, Scaling chisel 40x250	17	E-03115
	Drill 6 to 14, Bull point 140, 250, Cold chisel 20x140, 20x250, Scaling chisel 40x250	17	B-64680

Range	Size mm	Sales Pkg Qty	Part No.
★★★★☆	Drill 5.5 to 16, Bull point 250, Cold chisel 20x250	10	D-70904
	Drill 5.5 to 20, Bull point 250, Cold chisel 20x250	10	D-42391
	Drill 5 to 16, Bull point 250, Cold chisel 20x250	10	D-71990
	Drill 6 to 20, Bull point 250, Cold chisel 20x250	10	D-42385
	Drill 5 to 16, Bull point 250, Cold chisel 20x250	13	D-42400
	Drill 5 to 16, Bull point 250, Cold chisel 20x250	13	D-42416
	Drill 5 to 16, Bull point 250, Cold chisel 20x250	14	D-71174
	Drill 4 to 14.3, Bull point 140, 250, Cold chisel 20x250, 20x140, Scaling chisel 40x250	17	D-61008
	Drill 5 to 14, Bull point 140, 250, Cold chisel 20x250, 20x140, Scaling chisel 40x250	17	D-42438
	Drill 5 to 14, Bull point 140, 250, Cold chisel 20x250, 20x140, Scaling chisel 40x250	17	D-42444
★★★★☆	Drill 5 to 12, Bull point 140, 250, Cold chisel 20x140, 20x250, Scaling chisel 40x250	18	D-71180
	Drill 5 to 14, Bull point 140, 250, Cold chisel 20x140, 20x250, Scaling chisel 40x250	18	D-71196

TCT drill bit & chisel for SDS-PLUS hammers assortment in roll up pouch



Range	Size mm	Sales Pkg Qty	Part No.
★★★★☆	Drill 5.5 to 16, Bull point 250, Cold chisel 20x250	13	D-70895
	Drill 5 to 16, Bull point 250, Cold chisel 20x250	13	D-53659
	Drill 4 to 16, Bull point 140, 250, Cold chisel 20x140, 20x250, Scaling chisel 40x250	17	D-53300
	Drill 4 to 16, Bull point 140, 250, Cold chisel 20x140, 20x250, Scaling chisel 40x250	17	D-53609
	Drill 5 to 14, Bull point 140, 250, Cold chisel 20x140, 20x250, Scaling chisel 40x250	17	D-53073
	Drill 5 to 14, Bull point 140, 250, Cold chisel 20x140, 20x250, Scaling chisel 40x250	17	D-53621
	Drill 5 to 14, Bull point 140, 250, Cold chisel 20x140, 20x250, Scaling chisel 40x250	17	D-54863
	Drill 5 to 14, Bull point 140, 250, Cold chisel 20x140, 20x250, Scaling chisel 40x250	17	D-54863
	Drill 5 to 14, Bull point 140, 250, Cold chisel 20x140, 20x250, Scaling chisel 40x250	17	D-54863
	Drill 5 to 14, Bull point 140, 250, Cold chisel 20x140, 20x250, Scaling chisel 40x250	17	D-54863

TCT drill bit & chisel for SDS-PLUS hammers assortment in MAKPAC

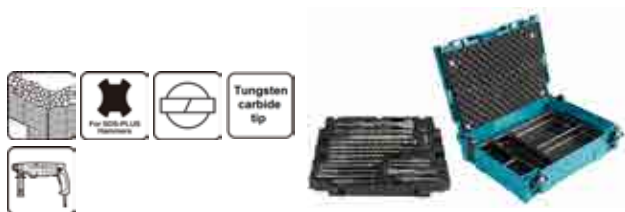

Range	Size mm	Sales Pkg Qty	Part No.
★★★★☆	Drill 5 to 14, Bull point 140, 250, Cold chisel 20x250, 20x140, Scaling chisel 40x250	17	B-52059
	Drill 5 to 14, Bull point 140, 250, Cold chisel 20x250, 20x140, Scaling chisel 40x250	17	B-53877

TCT drill bit & chisel for SDS-MAX hammers assortment in aluminum case

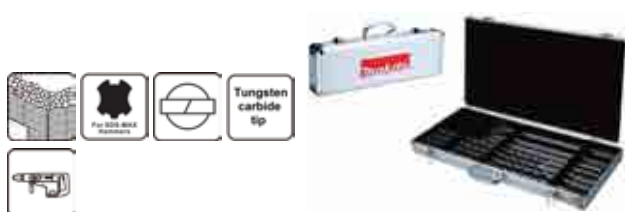

Range	Size mm	Sales Pkg Qty	Part No.
★★★★☆	Drill 18 to 25, Bull point 400, Cold chisel 25x400, Scaling chisel 50x400	7	D-40571

TCT drill bit & chisel for SDS-MAX hammers assortment in aluminum case with Makita blue



Range	Size mm	Sales Pkg Qty	Part No.
★★★★☆	Drill 18 to 25, Bull point 400, Cold chisel 25x400, Scaling chisel 50x400	7	D-42494

Chuck adapter for SDS-PLUS hammers



Range	Size mm	Sales Pkg Qty	Part No.
★★★★☆	M6x22	1	D-14093

ACCESSORIES

Fastening



Wood



Magnet



Double end



Flexible



1/2inch SQ



6.35hex shank MZ



6.35hex shank NZ



6.35hex shank C form



Hex shank



Pin ring



CR-MO

Fastener drive and screwdriving series

<p>1. C-form</p> 	
<p>2. E-form</p> 	
<p>3. Double ended</p> 	
<p>4. Bit holder</p> 	
<p>5. Nutsetter</p> 	
<p>6. Assortment</p> 	
<p>7. Socket adapter / Socket bit</p> 	
<p>8. Impact socket</p> 	
<p>9. Other</p> 	

PREMIER

*Double Torsion
for High Durability.*

*High Precision
Screw Fitting.*

*New Steel
is Used.
Supports High Torque.*

Fastening

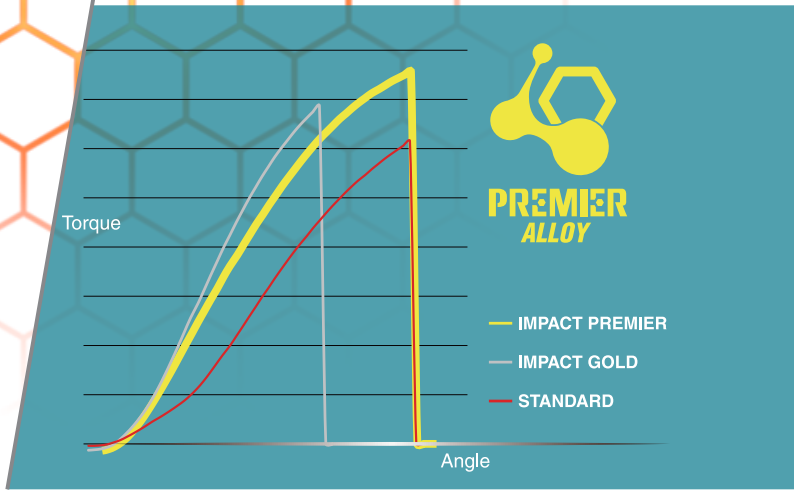
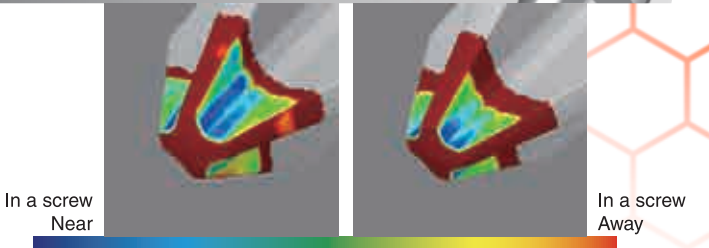

NEW INNOVATION



Torsion screw bit C-form Impact PREMIER



Range	Shank Type	Bit type	Length mm	Sales Pkg Qty	Part No.
★★★★★	C-form	PH 1	25	2	E-03121
		PH 2	25	2	E-03137
		PH 2	25	15	E-03246
		PH 2R	25	2	E-03143
		PH 3	25	2	E-03159
		PZ 1	25	2	E-03165
		PZ 2	25	2	E-03171
		PZ 2	25	15	E-03252
		PZ 3	25	2	E-03187
		T 10	25	2	E-03193
		T 15	25	2	E-03202
		T 20	25	2	E-03218
		T 25	25	2	E-03224
		T 30	25	2	E-03230

Torsion screw bit E-form Impact PREMIER



Range	Shank Type	Bit type	Length mm	Sales Pkg Qty	Part No.
★★★★★	E-form (MZ)	PH 1	50	2	E-03268
		PH 2	50	2	E-03274
		PH 2	50	10	E-03377
		PH 3	50	2	E-03280
		PZ 1	50	2	E-03296
		PZ 2	50	2	E-03305
		PZ 2	50	10	E-03383
		PZ 3	50	2	E-03311
		T 10	50	2	E-03327
		T 15	50	2	E-03333
		T 20	50	2	E-03349
		T 25	50	2	E-03355
		T 30	50	2	E-03361
		T 40	50	2	E-12027

Torsion screw bit E-form Impact PREMIER Assortment

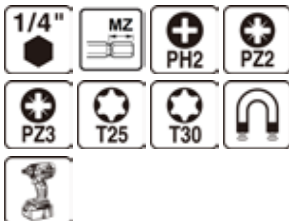

Range	Shank Type	Sales Pkg Qty	Part No.
★★★★★	E-form (MZ)	5	E-13568

Double ended torsion screw bit E-form Impact PREMIER



Range	Shank Type	Bit type	Length mm	Sales Pkg Qty	Part No.
★★★★★	E-form (MZ)	PH 2	65	2	E-06286
		PZ 2	65	2	E-06292

Torsion bit holder E-form Impact PREMIER



Range	Shank Type	Length mm	Sales Pkg Qty	Part No.
★★★★★	E-form (MZ)	68	1	E-03399
★★★★★	E-form (MZ)	150	1	E-03408

Ultra mag torsion bit holder E-form Impact PREMIER



Range	Shank Type	Length mm	Sales Pkg Qty	Part No.
★★★★★	E-form (MZ)	79	1	E-03414

Torsion nutsetter E-form Impact PREMIER



Range	Shank Type	Socket Size mm	Length mm	Sales Pkg Qty	Part No.
★★★★★	E-form (MZ)	6	65	1	E-03458
		8	65	1	E-03464
		10	65	1	E-03470
		13	65	1	E-03486

Tilt socket adapter E-form Impact PREMIER



Range	Shank Type	Bit type	Length mm	Sales Pkg Qty	Part No.
★★★★★	E-form (MZ)	1/2 inch Drive	50	1	E-03436
		3/8 inch Drive	50	1	E-03420

Tilt socket bit E-form Impact PREMIER



Range	Shank Type	Socket Size mm	Length mm	Sales Pkg Qty	Part No.
★★★★★	E-form (MZ)	13	75	1	E-03492
		15	75	1	E-03501
		17	75	1	E-03517
		19	75	1	E-03523
		21	80	1	E-03539

Mag boost Impact PREMIER



Range	Sales Pkg Qty	Part No.
★★★★★	1	E-03442

Torsion screw bit C-form Impact PREMIER with bit holder Assortment



Range	Shank Type	Sales Pkg Qty	Part No.
★★★★★	C-form & E-form (MZ)	11	E-03567
		11	E-03573
		31	E-13552

Double ended torsion screw bit E-form



Range	Shank Type	Bit type	Length mm	Sales Pkg Qty	Part No.
★★★★★	E-form (MZ)	PH 1	65	3	B-21836
		PH 1	85	3	B-21842
		PH 1	110	3	B-21858
		PH 2	65	3	B-20703
		PH 2	85	3	B-12326
		PH 2	110	3	B-21864
		PH 3	65	3	B-21870
		PH 3	85	3	B-21886
		PH 3	110	3	B-21892
		PZ 1	65	3	B-21901
		PZ 1	85	3	B-21917
		PZ 1	110	3	B-21923
		PZ 2	65	3	B-20719
		PZ 2	85	3	B-12790
		PZ 2	85	18	B-16259
		PZ 2	110	3	B-21939
		PZ 3	65	3	B-20725
		PZ 3	85	3	B-20731
		PZ 3	110	3	B-21945
		PH 2	65	3	B-55376

Screw bit C-form Impact BLACK



Range	Shank Type	Bit type	Length mm	Sales Pkg Qty	Part No.
★★★★☆	C-form	PH 1	25	2	B-63600
		PH 2	25	2	B-63616
		PH 2	25	25	E-12360
		PH 2	25	25x12sets	E-12360-12
		PH 3	25	2	B-63622
		PZ 1	25	2	B-63638
		PZ 2	25	2	B-63644
		PZ 2	25	25	E-12376
		PZ 2	25	25x12sets	E-12376-12
		PZ 3	25	2	B-63650
		T 15	25	2	B-63666
		T 20	25	2	B-63672
		T 20	25	25	E-12382
		T 20	25	25x12sets	E-12382-12
		T 25	25	2	B-63688
		T 25	25	25	E-12398
		T 25	25	25x12sets	E-12398-12
		T 30	25	2	B-63694
		T 30	25	25	E-12653
		T 30	25	25x12sets	E-12653-12
		T 40	25	2	B-63703
		T 40	25	25	E-12669
		T 40	25	25x12sets	E-12669-12

Screw bit E-form Impact BLACK



Range	Shank Type	Bit type	Length mm	Sales Pkg Qty	Part No.
★★★★☆	E-form (MZ)	PH 1	50	2	B-63719
		PH 2	50	2	B-63725
		PH 2	50	10	E-12407
		PH 2	50	10x12sets	E-12407-12
		PH 3	50	2	B-63731
		PZ 1	50	2	B-63747
		PZ 2	50	2	B-63753
		PZ 2	50	10	E-12413
		PZ 2	50	10x12sets	E-12413-12
		PZ 3	50	2	B-63769
		T 15	50	2	B-63775
		T 20	50	2	B-63781
		T 20	50	10	E-12429
		T 20	50	10x12sets	E-12429-12
		T 25	50	2	B-63797
		T 25	50	10	E-12435
		T 25	50	10x12sets	E-12435-12
		T 30	50	2	B-63806
		T 30	50	10	E-12675
		T 30	50	10x12sets	E-12675-12
		T 40	50	2	B-63812
		T 40	50	10	E-12681
		T 40	50	10x12sets	E-12681-12
E-form (NZ)	PH 2	50	2	E-08763	
	PH 3	50	2	E-08779	
	PH2	50	10	E-14211	

Screw bit E-form Impact BLACK Assortment



Range	Shank Type	Sales Pkg Qty	Part No.
★★★★☆	E-form (MZ)	10	E-12011
	E-form (NZ)	10	E-14233

Double ended screw bit E-form Impact BLACK



Range	Shank Type	Bit type	Length mm	Sales Pkg Qty	Part No.
★★★★☆	E-form (NZ)	PH 2	65	10	E-15827
	E-form (NZ)	PH 2	110	10	E-15833

Magnetic bit holder E-form Impact BLACK



Range	Shank Type	Length mm	Sales Pkg Qty	Part No.
★★★★☆	E-form (MZ)	60	1	B-66793
	E-form (NZ)	60	1	E-08785

Sleeve chuck bit holder E-form Impact BLACK



Range	Shank Type	Length mm	Sales Pkg Qty	Part No.
★★★★☆	E-form (MZ)	60	1	B-66802
	E-form (NZ)	60	1	E-08791

Screw guide bit holder E-form Impact BLACK

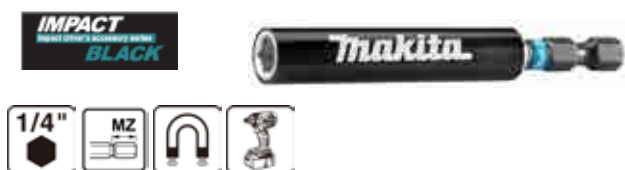

Range	Shank Type	Length mm	Sales Pkg Qty	Part No.
★★★★☆	E-form (MZ)	80	1	B-66818

Nutsetter E-form Impact BLACK



Range	Shank Type	Socket Size mm	Length mm	Sales Pkg Qty	Part No.
★★★★☆	E-form (MZ)	6	50	1	B-66824
		8	50	1	B-66830
		10	50	1	B-66846
		13	50	1	B-66852
	E-form (NZ)	6	50	1	E-08800
		8	50	1	E-08816
		10	50	1	E-08822
		13	50	1	E-08838

Nutsetter E-form Impact BLACK Assortment in clear case series



Range	Shank Type	Sales Pkg Qty	Part No.
★★★★☆	E-form (MZ)	6	E-15768
	E-form (NZ)	6	E-18035

Socket adapter E-form Impact BLACK



Range	Shank Type	Bit type	Length mm	Sales Pkg Qty	Part No.
★★★★☆	E-form (MZ)	1/2 inch Drive	50	1	B-66874
		3/8 inch Drive	50	1	B-66868
	E-form (NZ)	1/2 inch Drive	50	1	E-08850
		3/8 inch Drive	50	1	E-08844

Screw bit C-form Impact BLACK with bit holder Assortment



Range	Shank Type	Sales Pkg Qty	Part No.
★★★★☆	C-form & E-form (MZ)	8	E-11994
		10	E-12005
		10	E-15811
	C-form & E-form (NZ)	8	E-14227
		10	E-15849

Screw bit C & E-form Impact BLACK Assortment



Range	Shank Type	Sales Pkg Qty	Part No.
★★★★☆	C-form & E-form (MZ)	33	B-66896
		35	B-66880
	C-form & E-form (NZ)	33	E-06622
		35	E-06638
		33x10sets	E-06622-10
		35x10sets	E-06638-10

Screw bit C & E-form Impact BLACK Assortment in clear case series *Clear case*



Range	Shank Type	Sales Pkg Qty	Part No.
★★★★☆	C-form & E-form (MZ)	33x10sets	E-12441-10
★★★★☆	C-form & E-form (NZ)	33	E-15687

Screw bit C-form in blister



Range	Shank Type	Bit type	Length mm	Sales Pkg Qty	Part No.
★★★★☆	C-form	H 1.5	25	3	B-23662
		H 2.0	25	3	B-23678
		H 2.5	25	3	B-23684
		H 3.0	25	3	B-23690
		H 4.0	25	3	B-23709
		H 5.0	25	3	B-23715
		H 6.0	25	3	B-23721
		H 8.0	25	3	B-23737
		PH 1	25	3	B-23450
		PH 2	25	3	B-23466
		PH 3	25	3	B-23472
		PZ 1	25	3	B-23488
		PZ 2	25	3	B-23494
		PZ 3	25	3	B-23503
		SL 0.5x4.0	25	3	B-23519
		SL 0.6x4.5	25	3	B-23525
		SL 0.8x5.5	25	3	B-23531
		T 8	25	3	B-23581
		T 10	25	3	B-23597
		T 15	25	3	B-23606
		T 20	25	3	B-23612
		T 25	25	3	B-23628
		T 27	25	3	B-23634
		T 30	25	3	B-23640
		T 40	25	3	B-23656

Screw bit C-form in plastic case



Range	Shank Type	Bit type	Length mm	Sales Pkg Qty	Part No.
★★★★☆	C-form	PH 1	25	25	B-24577
		PH 2	25	25	B-24583
		PH 2	25	100	B-24876
		PH 2	25	250	B-62452
		PZ 1	25	25	B-24608
		PZ 2	25	25	B-24614
		PZ 2	25	100	B-24882
		PZ 3	25	25	B-24620
		T 15	25	25	B-24636
		T 20	25	25	B-24642
		T 25	25	25	B-24658
		T 30	25	25	B-24664

Screw bit C-form in plastic bag



Range	Shank Type	Bit type	Length mm	Sales Pkg Qty	Part No.
★★★★☆	C-form	PH 2	25	100	B-24957
		PZ 2	25	100	B-24963

Screw bit C-form Assortment



Range	Shank Type	Length mm	Sales Pkg Qty	Part No.
★★★★☆	C-form	25	3	B-24511
		25	3	B-24527
		25	3	B-24533
		25	10	D-73287
		25	10	D-73293

Screw bit for screwdriver C-form



Range	Shank Type	Bit type	Length mm	Sales Pkg Qty	Part No.
★★★★☆	C-form	PH 2	25	3	798398-4
		PH 3	25	3	798314-6

Dry wall bit C-form



Range	Shank Type	Bit type	Length mm	Sales Pkg Qty	Part No.
★★★☆☆	C-form	PH 2	30	1	D-61690

Screw bit E-form



Range	Shank Type	Bit type	Length mm	Sales Pkg Qty	Part No.
★★★☆☆	E-form (NZ)	SL 0.6x5.0	45	3	798301-5
		SL 1.0x6.35	45	3	798299-6
		SL 1.2x10.0	52	3	798303-1
		SL 1.2x8.0	70	3	798302-3

Screw bit E-form in blister



Range	Shank Type	Bit type	Length mm	Sales Pkg Qty	Part No.
★★★☆☆	E-form (MZ)	H 3.0	50	3	B-25448
		H 4.0	50	3	B-25454
		H 5.0	50	3	B-25460
		H 6.0	50	3	B-25476
		PH 1	50	3	B-25214
		PH 2	50	3	B-25220
		PH 2	90	1	B-57788
		PH 2	150	1	B-57847
		PH 3	50	3	B-25236
		PZ 1	50	3	B-25242
		PZ 2	50	3	B-25258
		PZ 2	90	1	B-59885
		PZ 2	150	1	B-59950
		PZ 3	50	3	B-25264
		SL 0.5x4.0	50	3	B-25286
		SL 0.6x4.5	50	3	B-25292
		SL 0.8x5.5	50	3	B-25301
		T 8	50	3	B-25351
		T 9	50	3	B-25367
		T 10	50	3	B-25373
		T 15	50	3	B-25389
		T 15	90	1	B-59900
		T 15	150	1	B-59972
		T 20	50	3	B-25395
		T 20	90	1	B-59916
		T 20	150	1	B-59988
		T 25	50	3	B-25404
		T 25	90	1	B-59922
		T 25	150	1	B-59994
		T 27	50	3	B-25410
		T 30	50	3	B-25426
		T 30	90	1	B-59938
		T 30	150	1	B-60006
		T 40	50	3	B-25432

Screw bit E-form in plastic case



Range	Shank Type	Bit type	Length mm	Sales Pkg Qty	Part No.
★★★☆☆	E-form (MZ)	PH 1	50	10	B-26238
		PH 2	50	10	B-26244
		PH 2	50	50	B-26490
		PH 2	50	100	B-62468
		PH 3	50	10	B-26250
		PZ 1	50	10	B-26266
		PZ 2	50	10	B-26272
		PZ 2	50	50	B-26509
		PZ 3	50	10	B-26288
		SQ 2	50	100	D-34920
		T 15	50	10	B-26294
		T 20	50	10	B-26303
		T 25	50	10	B-26319
		T 30	50	10	B-26325

Screw bit E-form in plastic bag



Range	Shank Type	Bit type	Length mm	Sales Pkg Qty	Part No.
★★★☆☆	E-form (MZ)	PH 2	50	50	B-26571
		PZ 2	50	50	B-26587

Screw bit E-form Assortment



Range	Shank Type	Length mm	Sales Pkg Qty	Part No.	
★★★☆☆	E-form (MZ)	50	3	B-26179	
		50	3	B-26185	
		50	3	B-26191	
		50	10	D-65028	
		50	10	D-65040	
		50	10	D-67620	
		E-form (NZ)	50	10	D-67620

Screw bit E-form Assortment in battery type case



Range	Shank Type	Length mm	Sales Pkg Qty	Part No.
★★★☆☆	E-form (MZ)	50	21	B-68323

Screw bit for screwdriver E-form



Range	Shank Type	Bit type	Length mm	Sales Pkg Qty	Part No.
★★★☆☆	E-form (NZ)	PH 2	122	5	A-45858
		PH 2	132	5	A-16536

Dry wall bit E-form



Range	Shank Type	Bit type	Length mm	Sales Pkg Qty	Part No.
★★★☆☆	E-form (MZ)	PH 2	40	1	B-60399

Double ended screw bit E-form



Range	Shank Type	Bit type	Length mm	Sales Pkg Qty	Part No.
★★★☆☆	E-form (MZ)	PH 1	65	10	D-65523
		PH 1	65	100	D-65517
		PH 2	65	10	D-34366
		PH 2	65	10	D-65078
		PH 2	65	100	D-31669
		PH 2	110	10	D-34849
	E-form (NZ)	PZ 2	65	100	D-34914
		PH 2	45	3	798308-1
		PH 2	45	10	D-34827
		PH 2	65	3	798309-9
		PH 2	65	10	D-33679
		PH 2	65	100	D-31653
		PH 2	65	100	D-63959
		PH 2	110	3	798337-4
		PH 2	110	10	D-34833
		PH 2	150	3	798338-2
		PH 3	45	3	798310-4
		PH 3	65	3	798311-2
PH 3	110	3	798339-0		

Double ended screw bit with 1/4inch Hex shank



Range	Shank Type	Bit type	Length mm	Sales Pkg Qty	Part No.
★★★☆☆	1/4 Inch Hex	PH 2-SL 5	65	10	D-65545
		PH 2-SL 5	65	100	D-65539
		PH 2-SL 5	110	10	D-65551

Magnetic bit holder for screwdriver E-form



Range	Shank Type	Length mm	Sales Pkg Qty	Part No.
★★★☆☆	E-form (MZ)	60	1	B-52445
		150	1	B-57750
		300	1	B-57766

Sleeve chuck bit holder E-form



Range	Shank Type	Length mm	Sales Pkg Qty	Part No.
★★★☆☆	E-form (MZ)	60	1	B-52467

Sleeve chuck bit holder for SDS-PLUS Hammers



Range	Shank Type	Length mm	Sales Pkg Qty	Part No.
★★★☆☆	SDS-PLUS	80	1	B-57548

Screw guide bit holder E-form



Range	Shank Type	Length mm	Sales Pkg Qty	Part No.
★★★☆☆	E-form (MZ)	80	1	B-48751
		120	1	B-48767
		120	1	B-52934
	E-form (NZ)	120	1	D-71037
		120	1	D-71043

Flexible bit holder with 1/4inch Hex shank



Range	Shank Type	Length mm	Sales Pkg Qty	Part No.
★★★☆☆	1/4 Inch Hex	190	1	A-86963
		200	1	B-29072
		300	1	B-29094

Flexible bit holder E-form



Range	Shank Type	Length mm	Sales Pkg Qty	Part No.
★★★★★	E-form (MZ)	300	1	B-51867
	E-form (NZ)	300	1	B-51851

Nutsetter E-form



Range	Shank Type	Socket Size mm(inch)	Length mm(inch)	Sales Pkg Qty	Part No.	
★★★★☆	E-form (MZ)	5.5	50	1	B-38685	
		6	50	1	B-38691	
		7	50	1	B-38700	
		8	50	1	B-38716	
		8	50	50	B-67773	
		10	50	1	B-38722	
		10	50	30	B-67789	
		11	50	1	B-61999	
		12	50	1	B-38738	
		13	50	1	B-38744	
		17	50	1	B-38750	
		(1/4)	50	1	B-38766	
		(5/16)	50	1	B-38772	
		(3/8)	50	1	B-38788	
		(3/8)	50	30	E-01878	
		(1/4)	50	50	E-01856	
		(5/16)	50	50	E-01862	
		(1/4)	(6)	1	B-57255	
		(5/16)	(6)	1	B-57261	
		(3/8)	(6)	1	B-57277	
		E-form (NZ)	8	50	50	B-68345
		E-form (NZ)	17	50	1	D-72964

Nutsetter C-form Assortment



Range	Shank Type	Socket Size mm	Length mm	Sales Pkg Qty	Part No.
★★★★☆	C-form	8,10,12,13	48	4	B-57554

Nutsetter E-form Assortment



Range	Shank Type	Socket Size mm(inch)	Length mm(inch)	Sales Pkg Qty	Part No.
★★★★☆	E-form (MZ)	(1/4,5/16,3/8)	(6)	3	B-57283
		6,8,10,12,13	50	5	B-39154

Socket adapter E-form



Range	Shank Type	Bit type	Length mm(inch)	Sales Pkg Qty	Part No.
★★★★☆	E-form (MZ)	1/2 inch Drive	50	1	B-54673
		1/4 inch Drive	152(6)	1	B-57744
		3/8 inch Drive	50	1	D-74740
	E-form (NZ)	3/8 inch Drive	50	1	B-54667
		1/2 inch Drive	152(6)	1	B-57738
		3/8 inch Drive	50	1	B-54695
			50	1	B-54689

Socket bit E-form Long type



Range	Shank Type	Socket Size mm	Length mm	Sales Pkg Qty	Part No.
★★★★☆	E-form (MZ)	10	75	1	B-52526
		10	150	1	B-52532
		10	300	1	B-52548
		10	500	1	B-52554
		10	700	1	B-52560
		13	75	1	B-52576
		13	150	1	B-52582
		13	300	1	B-52598
		13	500	1	B-52607
		13	700	1	B-52613
		17	75	1	B-52629
		17	150	1	B-52635
		17	300	1	B-52641
		17	500	1	B-52657
		17	700	1	B-52663

Threaded rod socket bit E-form



Range	Shank Type	Socket Size mm	Length mm	Sales Pkg Qty	Part No.
★★★★★	E-form (MZ)	M6	66	1	B-42961
		M8	66	1	B-42977
		M10	66	1	B-42983
		M6, M8, M10	66	3	B-42999

Bit catcher



Range	Note	Sales Pkg Qty	Part No.
★★★★☆	E-form (MZ)	1	B-54411
	E-form (NZ)	1	B-63105

Drill & drive bit



Range	Shank Type	Bit type	Note	Sales Pkg Qty	Part No.
★★★★☆	1/4 Inch Hex	PH 2	Drill is for #10 screw	1	D-73221
			Drill is for #6 screw	1	D-73209
			Drill is for #8 screw	1	D-73215

Drill & drive bit spare part



Range	Note	Sales Pkg Qty	Part No.
★★★★☆	Drill is for #10 screw	1	D-73259
	Drill is for #6 screw	1	D-73237
	Drill is for #8 screw	1	D-73243

Screw bit C-form with bit holder Assortment



Range	Shank Type	Sales Pkg Qty	Part No.
★★★★☆	C-form & E-form (MZ)	7	D-73265
		7	D-73271
		11	D-31756
		11	D-64995
		11	D-65006
		26	B-48773
		26	B-48789
		26	B-49890
		26	B-49909
		28x6sets	B-28911-6
		11x12sets	D-30651-12
		12x12sets	D-31083-12
		28x12sets	B-40347-12
		31x12sets	D-30667-12
		31x12sets	D-34936-12
		37x10sets	B-28606-10
		C-form & E-form (NZ)	11
	18x6sets		B-45412-6
	12x12sets		B-45381-12
	31x12sets		B-45406-12

Screw bit C & E-form Assortment



Range	Shank Type	Sales Pkg Qty	Part No.
★★★★☆	C-form & E-form	30	E-15774
		43	B-55697
	C-form & E-form (MZ)	29	D-73477
		30	B-68339
		32	D-65084
		32	D-65224
		47	D-73461
		18x6sets	B-28896-6
		18x12sets	B-43000-12
		C-form & E-form (NZ)	32
	18x6sets		B-45397-6

Screw bit C & E-form Assortment in clear case series

Clear case



Range	Shank Type	Sales Pkg Qty	Part No.
★★★★☆	C-form & E-form (MZ)	24	E-12619
		28	E-07048
		28	E-12625
		32	E-07076
		28x10sets	E-07048-10
		32x10sets	E-07076-10
	C-form & E-form (NZ)	28	E-07107
		32	E-07135
		28x10sets	E-07107-10
		32x10sets	E-07135-10

Screw bit C-form with bit holder Assortment in battery type case



Range	Shank Type	Sales Pkg Qty	Part No.
★★★★☆	C-form & E-form (MZ)	31	B-68317
		31x12sets	E-00022
	C-form & E-form (NZ)	31	B-69901

Impact socket Impact BLACK



Range	Shank Type	Socket Size mm	Length mm	Sales Pkg Qty	Part No.		
★★★★☆	1/2 Inch Drive	8	38	1	E-16047		
		9	38	1	E-16053		
		10	38	1	E-16069		
		11	38	1	E-16075		
		12	38	1	E-16081		
		13	38	1	E-16097		
		14	38	1	E-16106		
		15	38	1	E-16112		
		16	38	1	E-16128		
		17	38	1	E-16134		
		18	38	1	E-16140		
		19	38	1	E-16156		
		20	38	1	E-16162		
		21	38	1	E-16178		
		22	38	1	E-16184		
		23	38	1	E-16190		
		24	38	1	E-16209		
		27	42	1	E-16215		
		30	42	1	E-16221		
		32	44	1	E-16237		
		★★★★☆	3/8 Inch Drive	6	28	1	E-15877
				7	28	1	E-15883
8	28			1	E-15899		
9	28			1	E-15908		
10	28			1	E-15914		
11	28			1	E-15920		
12	28			1	E-15936		
13	28			1	E-15942		
14	28			1	E-15958		
15	28			1	E-15964		
16	28			1	E-15970		
17	30			1	E-15986		
18	30	1	E-15992				
19	30	1	E-16003				
20	30	1	E-16019				
21	30	1	E-16025				
22	30	1	E-16031				

Impact socket Impact BLACK Assortment

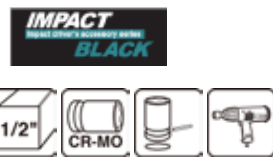

Range	Shank Type	Socket Size mm	Length mm	Sales Pkg Qty	Part No.
★★★★☆	1/2 Inch Drive	8 to 21	Assort	8	E-16601
		8 to 21		9	E-16570
		8 to 24		9	E-16564
		10 to 27		9	E-16617

Impact socket Impact BLACK with socket adapter Assortment



Range	Shank Type	Socket Size mm	Length mm	Sales Pkg Qty	Part No.	
★★★★☆	1/2inch SQ, E-form (MZ)	13 to 24	Assort	7	E-16592	
		8 to 18		9	E-16645	
		3/8inch SQ, E-form (MZ)		8 to 18	9	E-16639
		1/2inch SQ, E-form (NZ)		8 to 18	9	E-16623

Impact socket with socket adapter Assortment



Range	Shank Type	Bit type	Socket Size mm	Length mm	Sales Pkg Qty	Part No.
★★★★☆	E-form (MZ)	1/4 Inch	6 to 13	23	8	E-12289
		Drive	6 to 13	23	8	E-14336

Impact deep socket Impact BLACK



Range	Shank Type	Socket Size mm	Length mm	Sales Pkg Qty	Part No.
★★★★☆	1/2 Inch Drive	8	81.5	1	E-16405
		10	81.5	1	E-16411
		11	81.5	1	E-16427
		12	81.5	1	E-16433
		13	81.5	1	E-16449
		14	81.5	1	E-16455
		16	81.5	1	E-16461
		17	81.5	1	E-16477
		18	81.5	1	E-16483
		19	81.5	1	E-16499
		21	81.5	1	E-16508
		22	81.5	1	E-16514
		24	81.5	1	E-16520
		27	81.5	1	E-16536
		30	81.5	1	E-16542
		32	81.5	1	E-16558
	3/8 Inch Drive	7	63	1	E-16243
		8	63	1	E-16259
		9	63	1	E-16265
		10	63	1	E-16271
		11	63	1	E-16287
		12	63	1	E-16293
		13	63	1	E-16302
		14	63	1	E-16318
		15	63	1	E-16324
		16	63	1	E-16330
		17	63	1	E-16346
		18	63	1	E-16352
		19	63	1	E-16368
		20	63	1	E-16374
		21	63	1	E-16380
		22	63	1	E-16396

Impact deep socket Impact BLACK Assortment



Range	Shank Type	Socket Size mm	Length mm	Sales Pkg Qty	Part No.
★★★★☆	1/2 Inch Drive	10 to 32	Assort	14	E-16586

Impact deep socket for wheel nut Assortment



Range	Shank Type	Socket Size mm	Length mm	Sales Pkg Qty	Part No.
★★★★☆	1/2 Inch Drive	17,19,21	86	3	E-12354

Impact socket extension bar



Range	Shank Type	Bit type	Length mm	Sales Pkg Qty	Part No.
★★★★☆	1/2 Inch Drive	1/2 inch Drive	75	1	B-55728
			150	1	B-55712
			250	1	B-55706

Impact socket spare part



Range	Shank Type	Socket Size mm	Note	Sales Pkg Qty	Part No.
★★★★☆	1/2 Inch Drive	17	O ring set	3	B-54558
		17	Pin set	3	B-54592
		8 to 16	O ring set	3	B-54542
		8 to 16	Pin set	3	B-54586
		18 to 19	O ring set	3	B-54564
		18 to 19	Pin set	3	B-54601
		20 to 32	O ring set	3	B-54570
		20 to 32	Pin set	3	B-54617

Bit adapter



Range	Shank Type	Bit type	Length mm	Sales Pkg Qty	Part No.
★★★★☆	1/2 Inch Drive	7/16 Inch Hex	50	1	B-68460
		E-form (MZ)	51	1	B-68448
		E-form (NZ)	57	1	B-68476
	3/8 Inch Drive	E-form (MZ)	51	1	B-68454
		E-form (NZ)	57	1	B-68482

Screw bit & socket Assortment in clear case series

Clear case



Range	Shank Type	Sales Pkg Qty	Part No.
★★★★☆	C-form & E-form (MZ)	30	E-07060
		30	E-12631
	C-form & E-form (NZ)	30x10sets	E-07060-10
		30	E-07129
		30x10sets	E-07129-10

Screw bit & socket with ratchet handle Assortment



Range	Shank Type	Sales Pkg Qty	Part No.
★★★★☆	C-form & E-form	21	B-54081







ACCESSORIES

▣ Drill and Screw Bit Sets

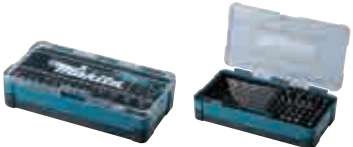

Accessory set Lineup

Series	Pcs.	Contents							Part No.	
		Drill bit			Hole saw	Screw bit	Nut setter	Hand tool	Screw bit shank type	
		Metal	Wood	Masonry					MZ	NZ
MAKPAC ★★★★★  MAKPAC accessory set comes with Makpac type 1. It consists of drill bit, screw bit and hand tools.	56	✓	✓			✓	✓		B-53768	
	62	✓	✓	✓		✓	✓		B-53908	
	65	✓	✓	✓		✓	✓	✓	B-69478 *Screw bit shank type is C-form	
	66	✓	✓			✓	✓		B-43044	B-43072
	69	✓	✓	✓		✓	✓		B-49638	
	87					✓		✓	E-11542	
	96	✓	✓	✓		✓	✓	✓	B-49725	
	116	✓	✓	✓		✓	✓	✓	B-49884	
	120					✓		✓	E-08713	
MACCESS ★★★★★  MACCESS series contains high quality items of screw bits, drill bits, hand tools, and so on. We are sure that the professional users will be satisfied with these bit sets of MACCESS.	34	✓	✓	✓		✓	✓		D-36980	
	71	✓	✓	✓		✓	✓	✓	D-33691	
	104	✓	✓	✓		✓	✓	✓	D-31778	
	200	✓	✓	✓	✓	✓	✓	✓	D-37194	
Circle ★★★  Circle series comes with bit and hand tool set. These series are more reasonable than MACCESS series.	50	✓	✓	✓		✓		✓	D-42014-6	D-53687
	65					✓		✓	D-42020-6	
	71	✓	✓	✓		✓		✓	D-47145-6	D-53001
	100	✓	✓	✓	✓	✓		✓	D-42036-5	
	103	✓	✓	✓	✓	✓		✓	D-42042-5	D-53017
Square ★★★  Square series does not contain neither high quality expensive items nor hand tools, to keep it less expensive.	17	✓		✓		✓			D-40200	D-53693
	30	✓	✓	✓		✓			D-47204-10	D-53702
	34	✓	✓	✓		✓	✓		B-68498	
	42	✓				✓	✓		D-58877	
	77	✓	✓	✓		✓	✓		D-47226-5	
	100	✓	✓	✓		✓	✓		D-47248-5	
	201	✓	✓	✓	✓	✓	✓		D-47260-2	

Series	Pcs.	Contents							Part No.	
		Drill bit			Hole saw	Screw bit	Nut setter	Hand tool	Screw bit shank type	
		Metal	Wood	Masonry					MZ	NZ
Accessory set ★★★  <p>Accessory set series is the set item with the reasonable price.</p>	60	✓	✓	✓		✓	✓		E-11829	
		✓	✓	✓		✓		✓	E-15095	
	75	✓	✓	✓		✓	✓		B-49373	
	80	✓	✓	✓		✓		✓	E-15104	
	91					✓		✓	E-15752	
	100	✓	✓	✓	✓	✓	✓		B-54520	
		✓	✓	✓	✓	✓	✓		B-54879	
	102	✓	✓	✓		✓	✓		B-68432	
		✓	✓	✓	✓	✓	✓	✓	E-10730	
	212	✓	✓	✓	✓	✓	✓	✓	E-06270	
256	✓	✓	✓	✓	✓	✓	✓	E-11689		
Hand tool ★★★  <p>The hand tool series is the set that mainly includes hand tools. Because hand tools are heavy, 8 corners of the case are covered by plastic having Impact resistance composites.</p>	76					✓		✓	E-10899	
	87					✓		✓	E-08458	
	120					✓		✓	E-06616	
	221					✓		✓	E-10883	
Tablet case ★★★  <p>This is a slim case set and easy to carry and it is stylish design. You can put in and take out the bits smoothly and it will increase your work effort.</p>	33	✓	✓	✓		✓	✓		B-49389	
Clear case ★★★  <p>Clear cover makes it visible inside. Comparing to current items, clear case was designed to be able to be stacked stably.</p>	18			✓		✓	✓		E-07026 E-07026-10	E-07082 E-07082-10
	28					✓	✓		E-07048 E-07048-10	E-07107 E-07107-10
	29	✓	✓	✓		✓			E-07054 E-07054-10	E-07113 E-07113-10
Clear case ★★★ 	17	✓	✓	✓					D-74887	D-77207
	47					✓	✓	✓	B-36170-10	
	48	✓				✓	✓		B-36192-10	
	75	✓	✓	✓		✓	✓		E-15126	E-15110
Compact case ★★★ 	38	✓				✓	✓		B-54106	
	71	✓	✓			✓			B-50295	

ACCESSORIES

▣ Cutting



Wood



Plaster board



Epoxy



Plastic



Fiberglass



TC grit 30-40



TC grit 40-50



Low noise

T.C.T Saw Blade

Tooth shape



ATB
Alternate top bevel
For wood and aluminum.

ATBR
Added flat teeth to
ATB for easy straight
cutting

Hi-ATB
Alternate top bevel (ATB)
with a larger top bevel
angle

ATAF
Alternate top alternate face
Enables to cut wood fiber
sharply.

ATAFR
Added flat teeth to ATAF for
easy straight cutting.
MATAFR: Modified ATAFR
for less cutting resistance.

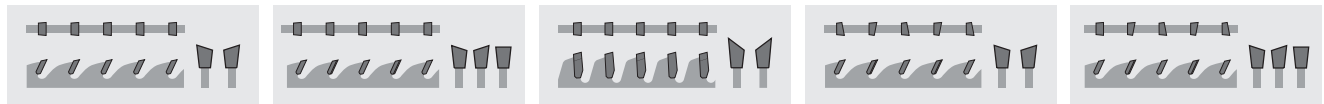

M-FORCE
Tooth front and top shapes
symmetric V groove having
features of ATB and FTG.



FTG
Flat teeth, allows easy
straight cutting and tips are
rarely chipped. For cutting
wood along the grain and
cutting thin metal.



TCG
Trapezoidal and flat teeth are
arranged alternatively and
they divide debris by three.
Allows easy straight cutting
and tips are rarely chipped.



MTCG
Flat teeth with alternating
bevel Less cutting
resistance than flat teeth.
Tips are rarely chipped



SMTCG
Contrast to MTCG,
asymmetric two levels on a
tooth top producing sharp
edges Allows easy bite to
materials.

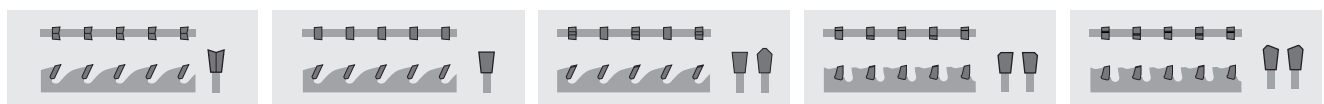

Technical term



Laser Slit

Vibration dampening system
Resinbond filled laser cut body
slots for smoother and quieter
cuts.

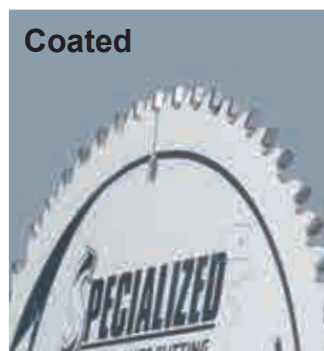

Coated

PTFE (polytetrafluoroethylene)
coating plate to reduce pitch
build-up and to lower
resistance.

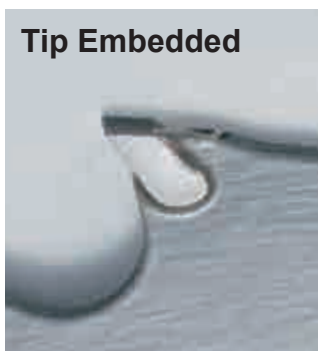

Tip Embedded

Inserted tooth design will greatly
increases the body-to-tip
brazing area for greater support and
tip strength.

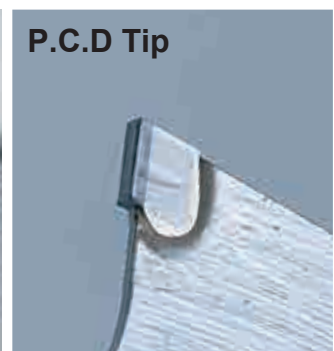

P.C.D Tip

PCD (Poly-Crystalline Diamond)
tips has extreme hardness and
wear resistance. PCD tipped
saw blade is the best choice for
long lasting performance when
cutting fiber cement board.



Feature

Sharp top angle

Enable you to make a fine cut surface with only little effort.

Curved body

Allows the excellent chip chute performance.

Slimmed bottom

Realizes long life battery by saving cutting resistance.

More cuts per charge

Fast cutting

Longer life

The amount of cutting per 1 charge

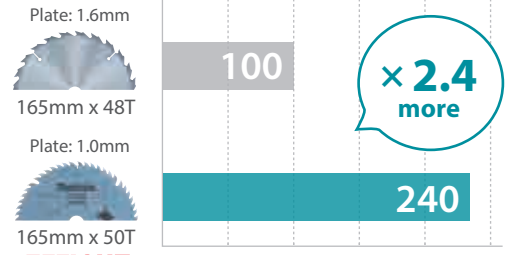

The test results depend to a great extent on the hardness of wood materials, etc.



This movie was filmed in Japan. Models and specs may vary by country.

Cutting



Feature

Curved body

Allows the excellent chip chute performance.

Slimmed bottom

Realizes long life battery by saving cutting resistance.

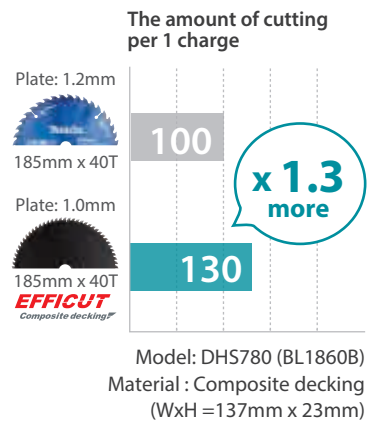

Following the tooth design of Efficut for wood with

- Tip hardness was improved
- Having obtuse tip angle then realized longer life and more cuts per charge.

EFFICUT Composite decking

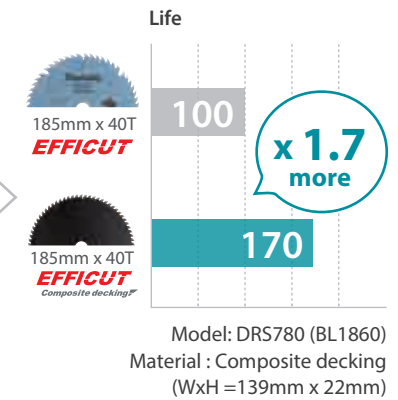

Feature

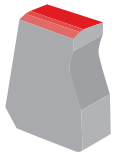

Strong and least chipping
 Special blade tip design greatly improves efficiency and durability.



Release swarf smoothly

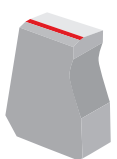

Superior in straight cutting
 The load on blade tips can be distributed efficiently to suppress wobbling of saw blade, providing steady straight cutting and increased durability against tip breakage.



More cuts per charge



Fast cutting



Longer life

The amount of cutting per 1 charge

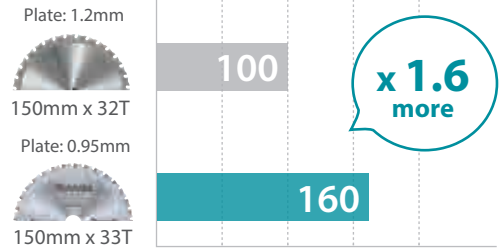

Model: DCS553 (BL1860B)
 Material: Carbon steel pipe (Dia: 31mm / Thickness: 3mm)



This movie was filmed in Japan.
 Models and specs may vary by country.



Feature

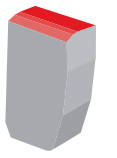

Strong and least chipping
 Special blade tip design greatly improves efficiency and durability.

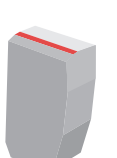

Superior in straight cutting
 The load on blade tips can be distributed efficiently to suppress wobbling of saw blade, providing steady straight cutting and increased durability against tip breakage.



Reduce cutting resistance
 Realizes high durability and reduce cut resistance.



Allows the excellent chip ejection.
 Realizes long life battery by saving cutting resistance.



More cuts per charge



Fast cutting



Longer life



Clean cutting

The amount of cutting per 1 charge

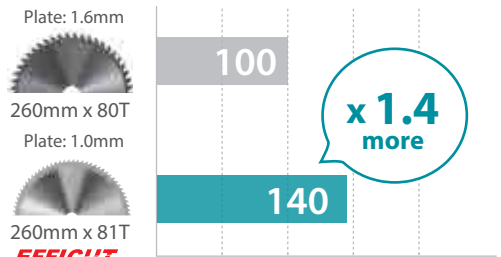

Model: DLS110(BL1860B x2)
 Material : Aluminum frame (WxH=45x45mm, t=2mm)



This movie was filmed in Japan.
 Models and specs may vary by country.

TCT Saw Blade for Circular Saw EFFICUT General



Range	Work Material	Outer dia. mm	No. teeth	Kerf mm	Plate mm	Hole dia. mm	Rake	Tooth shape	Note	Sales Pkg Qty	Part No.
★★★★★	Wood	125	45	1.4	1	20	23	ATAFR	-	1	B-69462
		165	25	1.4	1	20	23	ATAFR	-	1	B-63018
		185	24	1.45	1	19	23	ATAFR	-	1	B-64375
		185	24	1.45	1	20	23	ATAFR	-	1	B-62022
		185	45	1.45	1	20	23	ATAFR	-	1	B-68616
		190	24	1.45	1	20	23	ATAFR	-	1	B-64200
		190	45	1.45	1	20	23	ATAFR	EAC mark only	1	B-68644
		235	24	2.2	1.5	25	20	ATBR	-	1	E-01959
		235	24	2.2	1.5	25.4	20	ATBR	-	1	E-01937
		260	24	2.15	1.5	25	23	ATAFR	-	1	E-07733
		260	24	2.15	1.5	25.4	23	ATAFR	-	1	E-07749
		270	24	2.15	1.5	25.4	23	ATAFR	-	1	E-12974
	Wood,MDF	165	56	1.45	1	20	23	ATAFR	-	1	B-57364

TCT Saw Blade for Miter Saw Table Saw EFFICUT General



Range	Work Material	Outer dia. mm	No. teeth	Kerf mm	Plate mm	Hole dia. mm	Rake	Tooth shape	Sales Pkg Qty	Part No.
★★★★★	Wood	165	60	1.85	1.35	20	10	ATBR	1	B-69892
		190	25	1.85	1.35	20	10	ATBR	1	E-11265
		190	45	1.85	1.35	20	10	ATBR	1	E-11271
		190	60	1.85	1.35	20	10	ATBR	1	E-11287
		216	45	2	1.5	25.4	10	ATBR	1	E-07010
		216	60	2	1.5	25.4	10	ATBR	1	E-08969
		216	80	2	1.5	25.4	10	ATBR	1	E-08975
		260	45	2.15	1.65	25.4	10	ATAFR	1	B-64668
		260	60	2.15	1.65	25.4	10	ATAFR	1	B-67430
		260	80	2.15	1.65	25.4	10	ATAFR	1	B-67446
		305	60	2.15	1.65	25.4	10	ATAFR	1	B-67452
		305	80	2.15	1.65	25.4	10	ATAFR	1	B-67468
		305	100	2.15	1.65	25.4	10	ATAFR	1	B-67474

TCT Saw Blade for Circular Saw EFFICUT Composite decking General



Range	Work Material	Outer dia. mm	No. teeth	Kerf mm	Plate mm	Hole dia. mm	Rake	Tooth shape	Sales Pkg Qty	Part No.
★★★★★	Wood	185	40	1.5	1	20	15	ATAFR	1	E-11972

TCT Saw Blade for Miter Saw Table Saw EFFICUT Composite decking General



Range	Work Material	Outer dia. mm	No. teeth	Kerf mm	Plate mm	Hole dia. mm	Rake	Tooth shape	Sales Pkg Qty	Part No.
★★★★★	Wood	260	75	2.15	1.65	25.4	8	ATAFR	1	E-11988

TCT Saw Blade for Metal Cutting EFFICUT General



Range	Work Material	Outer dia. mm	No. teeth	Kerf mm	Plate mm	Hole dia. mm	Rake	Tooth shape	Sales Pkg Qty	Part No.
★★★★★	Wood	150	25	1.4	1	20	23	ATAFR	1	E-06937

TCT Saw Blade for Metal Cutting EFFICUT Metal General



Range	Work Material	Outer dia. mm	No. teeth	Kerf mm	Plate mm	Hole dia. mm	Rake	Tooth shape	Sales Pkg Qty	Part No.
★★★★★	Metal	136	30	1.1	0.95	20	0	SMTCCG	1	B-69428
		150	33	1.1	0.95	20	0	SMTCCG	1	B-69440
		185	45	1.4	1.2	20	0	SMTCCG	1	E-12918
		305	63	2	1.75	25.4	-2	SMTCCG	1	E-12083
	Metal,SUS	136	45	1.1	0.95	20	0	SMTCCG	1	B-69434
		150	48	1.1	0.95	20	0	SMTCCG	1	B-69456
		185	60	1.4	1.2	20	0	SMTCCG	1	E-12924
		305	96	2	1.75	25.4	-3	SMTCCG	1	E-19788

TCT Saw Blade for Miter Saw Table Saw EFFICUT Aluminum General



Range	Work Material	Outer dia. mm	No. teeth	Kerf mm	Plate mm	Hole dia. mm	Rake	Tooth shape	Sales Pkg Qty	Part No.
★★★★★	Aluminum	165	54	1.50	1.15	20	-3	SMTCCG	1	E-16798
		185	60	1.70	1.35	20	0	SMTCCG	1	E-16841
		190	60	1.70	1.35	20	0	SMTCCG	1	E-16891
		216	63	1.85	1.50	25.4	0	SMTCCG	1	E-16944
		260	81	1.85	1.5	25.4	-3	SMTCCG	1	E-06345
		305	81	2	1.65	25.4	-3	SMTCCG	1	E-13281
		305	96	2	1.65	25.4	-3	SMTCCG	1	E-13340

TCT Saw Blade for Circular Saw Wood M-FORCE General



Range	Work Material	Outer dia. mm	No. teeth	Kerf mm	Plate mm	Hole dia. mm	Ring mm(inch)	Rake	Tooth shape	Sales Pkg Qty	Part No.
★★★★☆	Wood	165	16	2	1.2	20	-	15	M-FORCE	1	A-89626
		165	16	2	1.2	20	-	15	M-FORCE	1	A-89698
		165	24	2	1.2	20	-	15	M-FORCE	1	A-89632
		165	24	2	1.2	20	-	15	M-FORCE	1	A-89707
		185	16	2	1.2	20	-	15	M-FORCE	1	A-89713
		185	16	2	1.2	30	16, 20(5/8, 13/16)	15	M-FORCE	1	A-89648
		185	24	2	1.2	20	-	15	M-FORCE	1	A-89729
		185	24	2	1.2	20	-	15	M-FORCE	1	B-03816
		185	24	2	1.2	30	16, 20(5/8, 13/16)	15	M-FORCE	1	A-89654
		235	20	2.3	1.6	20	-	15	M-FORCE	1	B-04092
		235	20	2.3	1.6	30	15.88, 25(5/8, 1)	20	M-FORCE	1	B-04117
		235	40	2.3	1.6	20	-	15	M-FORCE	1	B-04101
		235	40	2.3	1.6	30	15.88, 25(5/8, 1)	20	M-FORCE	1	B-04123

TCT Saw Blade for Circular Saw Wood General



Range	Work Material	Outer dia. mm	No. teeth	Kerf mm	Plate mm	Hole dia. mm	Ring mm(inch)	Rake	Tooth shape	Note	Sales Pkg Qty	Part No.
★★★★★	Wood	190	44	1.45	1	19	-	10, 30	ATAF	Tooth shape: Double cut	1	B-60420
			44	1.45	1	20	-	23	ATAFR		1	B-54514
	Wood,MDF	165	44	1.45	1	20	-	23	ATAFR	Tooth shape: Double cut, Fluorine coating, Laser slit	1	B-53279
		190	44	1.45	1	20	-	23	ATAFR		1	B-54508
★★★★☆	Wood,MDF	165	55	1.6	1.1	20	-	20	ATAFR	Fluorine coating, Laser slit	1	B-57059
★★★★☆	Wood	85	20	1	0.7	15	-	10	ATB	-	1	792623-5
			20	1	0.7	15	-	10	ATB	-	1	B-14607
		110	12	1.85	1.25	20	-	20	ATB	-	1	A-81723
			24	1.8	1.2	20	-	10	ATAF	-	1	A-81359
			24	1.8	1.2	20	-	10	ATAF	-	1	A-88864
			30	1.8	1.2	20	-	10	ATB	-	1	A-81365
		136	16	1.5	1	20	-	20	ATAF	-	1	B-09949
			16	1.5	1	20	-	20	ATAF	-	1	B-53659
			36	1.5	1	20	-	18	ATAF	-	1	B-46800
		160	24	2.2	1.4	20	-	25	ATAF	-	1	A-81371
			30	2.2	1.4	20	-	20	ATAF	-	1	A-81876
			32	2.2	1.4	20	-	20	ATAF	-	1	A-81387
			36	2.2	1.4	20	-	20	ATAF	-	1	A-81882
			40	1.6	1	20	-	18	ATB	-	1	A-80612
			40	2.2	1.4	20	-	20	ATAF	-	1	A-81898
			48	2.2	1.4	20	-	20	ATAF	-	1	A-81907
			60	2	1.4	20	-	15	ATAF	-	1	A-82688
			60	2.2	1.4	20	-	15	ATB	-	1	A-81393
			10	2	1.4	20	-	20	FTG	-	1	B-02917
		165	24	1.5	1	20	-	20	ATAF	-	1	A-85101
			24	1.5	1	20	-	20	ATAF	-	1	A-85117
			24	1.6	1	20	15.88	18	ATBR	Thin kerf	1	E-15665
			40	1.6	1	20	-	18	ATAF	-	1	A-82454
			40	1.6	1	20	-	18	ATAF	-	1	A-85195
			40	1.6	1	20	-	18	ATAF	-	1	A-85226
			40	1.6	1	20	-	18	ATAF	-	1	B-45565
			44	1.45	1	20	-	23	ATAFR	-	1	B-53285
			52	1.6	1	20	-	20	ATAF	-	1	A-85189
			52	1.6	1	20	-	20	ATAF	-	1	A-85204
		180	60	1.6	1	20	-	18	ATAF	-	1	A-82460
			24	2.2	1.4	20	-	25	ATAF	-	1	A-81402
			30	2.2	1.4	20	-	20	ATAF	-	1	A-81913
			36	2.2	1.4	20	-	20	ATAF	-	1	A-81929
			40	2.2	1.4	20	-	20	ATAF	-	1	A-81418
			48	2.2	1.4	20	-	20	ATAF	-	1	A-81935
			60	2	1.4	20	-	15	ATAF	-	1	A-82694
		185	60	2.2	1.4	20	-	15	ATAF	-	1	A-81424
			24	1.6	1	20	15.88	18	ATBR	Thin kerf	1	E-15671
			40	1.6	1	19	-	18	ATAF	-	1	B-05181
			40	1.6	1	20	-	18	ATAF	-	1	A-82476
			40	1.6	1	20	-	18	ATAF	-	1	A-85145
			40	2	1.4	20	-	18	ATAF	-	1	A-85999
			60	1.6	1	19	-	18	ATAF	-	1	B-45587
		190	60	1.6	1	20	-	18	ATAF	-	1	A-82482
			12	2	1.4	30	-	20	FTG	-	1	B-02939
			24	2	1.4	20	-	20	ATAF	-	1	A-87507
			24	2	1.4	30	-	20	ATAF	-	1	A-87258
			40	2	1.4	30	-	10	ATAF	-	1	A-87301
			72	1.5	1	19	-	15	ATAF	-	1	B-49694
		195	72	1.6	1	19	-	15	ATAF	-	1	B-49688
			80	2.2	1.5	25.4	-	15	ATB	-	1	B-44890
			16	2.6	1.8	30	-	20	FTG	-	1	B-27274
			16	2.6	1.8	30	-	20	FTG	-	5	B-27274-5
			20	2.3	1.6	25	-	20	ATB	-	1	A-89947
			20	2.3	1.6	30	25	25	ATAF	-	1	A-80678
			20	2.3	1.6	30	-	20	ATB	-	1	A-89866
			24	2.6	1.8	25.4	-	25	ATB	-	1	A-81985
			30	2.6	1.8	25.4	25(1)	25	ATB	-	1	A-81991
			36	2.6	1.8	25.4	25(1)	25	ATB	-	1	A-82002
		235	40	2.6	1.8	25.4	25(1)	25	ATAF	-	1	A-81468
48	2.3		1.6	30	25(1)	18	ATB	-	1	A-81795		
48	2.6		1.8	25.4	25(1)	20	ATAF	-	1	A-82018		
60	2.3		1.6	30	25(1)	20	ATB	-	1	B-12865		
60	2.4		1.6	25.4	25(1)	20	ATAF	-	1	A-82719		

Range	Work Material	Outer dia. mm	No. teeth	Kerf mm	Plate mm	Hole dia. mm	Ring mm(inch)	Rake	Tooth shape	Note	Sales Pkg Qty	Part No.
★★★★☆☆	Wood	235	60	2.6	1.8	25.4	25(1)	20	ATAF	-	1	A-81474
			80	2.4	1.6	25.4	-	15	ATAF	-	1	B-45602
			80	2.6	1.6	25.4	25(1)	15	ATB	-	1	A-81480
			100	2.4	1.6	25.4	-	10	ATAF	-	1	B-45618
		260	24	2.3	1.6	25.4	-	20	ATB	-	1	B-10584
			18	2.6	1.8	25.4	-	20	ATB	-	1	B-12843
		270	18	2.6	1.8	30	-	20	ATB	-	1	B-12859
			24	2.6	1.8	30	25(1)	23	ATB	-	1	A-81804
			24	2.6	1.8	30	-	20	ATB	-	1	B-04232
			40	2.6	1.8	30	25(1)	18	ATB	-	1	A-81816
		335	60	2.6	1.8	30	25(1)	18	ATB	-	1	A-81826
			60	3	2.2	25	-	20	ATB	-	1	B-12603
			60	3	2.2	30	25(1)	20	ATB	-	1	B-04248
			20	3	2.2	30	-	27	ATAF	-	1	A-80014
			24	3	2.2	30	-	20	ATB	-	1	B-04254
			24	3	2.2	30	-	23	ATB	-	1	A-81832
			40	3	2.2	30	-	20	ATB	-	1	B-04260
			40	3	2.2	30	-	23	ATB	-	1	A-81848
			60	3	2.2	30	-	18	ATB	-	1	A-81854
			60	3	2.2	30	-	20	ATB	-	1	B-04276
		415	60	2.6	1.8	25	-	20	ATAF	-	1	792118-8
			12	1.7	1.1	20	-	15	ATB	-	1	D-15562
		110	24	1.7	1.1	20	-	10	ATB	-	1	D-15578
			30	1.6	1	20	-	10	SMTCCG	-	1	B-39475
			16	2	1.3	20	16	20	ATB	-	1	D-16433
		160	24	2	1.3	20	16	20	ATB	-	1	D-34257
			40	2	1.3	20	16	18	ATB	-	1	D-34263
			10	2	1.3	20	-	20	ATB	-	1	D-03327
		165	16	1.5	1	20	-	20	ATB	-	1	D-51079
			16	2	1.3	20	-	20	ATB	-	1	D-09628
			24	2	1.3	20	-	20	ATB	-	1	D-03333
			40	2	1.3	20	-	18	ATB	-	1	D-03349
185	16	2	1.3	30	16, 20	20	ATB	-	1	D-03903		
	20	2	1.3	30	16, 20	20	ATB	-	1	D-09634		
	24	1.8	1.2	20	-	20	ATB	-	1	D-19037		
	24	1.8	1.2	20	-	20	ATB	Price competitive	1	D-51275		
	24	1.8	1.2	20	-	20	ATB	TWIN-PACK (2xD-19037)	2	D-34279		
	24	2	1.3	20	-	20	ATB	-	1	D-03355		
	40	2	1.3	20	-	18	ATB	-	1	D-03361		
	40	2	1.3	30	16, 20	18	ATB	-	1	D-03919		
190	40	2.2	1.4	20	-	15	ATB	-	1	P-83901		
	60	2.2	1.5	19	-	-5	TCG	-	1	D-61597		
	60	2.2	1.5	20	-	-5	TCG	-	1	D-59427		
	60	2.4	1.5	20	15.88	12	TCG	-	1	D-21381		
	60	2.4	1.5	30	16, 20	12	TCG	-	1	D-17902		
	60	2.4	1.5	30	15.88, 20	12	ATB	-	1	D-38934		
	24	2	1.3	30	-	18	ATB	EAC mark only	1	D-64973		
	80	2	1.3	25.4	16, 20	10	ATB	-	1	D-16396		
	24	2	1.3	25	-	20	ATB	-	1	D-29066		
	210	24	2	1.3	25	-	20	ATB	-	1	D-34291	
24		2	1.3	30	-	20	ATB	-	1	D-29050		
40		2	1.3	25	-	18	ATB	-	1	D-34300		
235	20	2.4	1.6	25	-	20	ATB	-	1	D-15811		
	20	2.4	1.6	30	25, 25.4	20	ATB	-	1	D-03925		
	24	2.4	1.6	25	-	20	ATB	TWIN-PACK (2xD-19819)	2	D-34316		
	40	2.4	1.6	25	-	18	ATB	-	1	D-16570		
	40	2.4	1.6	25.4	25	18	ATB	-	1	D-03377		
	48	2.4	1.6	30	25	18	ATB	-	1	D-03931		
	60	2.4	1.6	25	-	15	ATB	-	1	D-34322		
	60	2.4	1.6	30	25	15	ATB	-	1	D-09640		
80	2.8	1.8	30	25	12	TCG	-	1	D-17918			
136	40	1.5	1	20	-	20	ATB	-	1	D-59156		
	16	2	1.2	20	-	12	ATB	-	1	D-50485		
165	16	2	1.2	20	-	12	ATB	-	1	D-52554		
	24	2	1.2	20	-	12	ATB	-	1	D-50491		
	24	2	1.2	20	-	12	ATB	-	1	D-52560		
	40	2	1.2	20	-	12	ATB	-	1	D-50500		
	40	2	1.2	20	-	12	ATB	-	1	D-52576		
	40	2	1.2	20	-	12	ATB	-	10	D-50500-10		
185	16	2.2	1.4	25.4	20	18	ATB	-	1	D-50516		
	16	2.2	1.4	30	-	18	ATB	-	1	D-52582		
	20	2.2	1.4	25.4	20	15	ATB	-	1	D-59112		
	20	2.2	1.4	30	-	15	ATB	-	1	D-59134		
	24	2.2	1.4	25.4	20	15	ATB	-	1	D-50522		
	24	2.2	1.4	25.4	20	15	ATB	-	1	D-50522-10		
	24	2.2	1.4	30	-	15	ATB	-	1	D-52598		
	40	2.2	1.4	19	-	14	ATB	For Korea	1	D-57124		
	40	2.2	1.4	25.4	20	14	ATB	-	1	D-50538		

Range	Work Material	Outer dia. mm	No. teeth	Kerf mm	Plate mm	Hole dia. mm	Ring mm(inch)	Rake	Tooth shape	Note	Sales Pkg Qty	Part No.	
★★★★★	Wood	185	40	2.2	1.4	30	20	14	ATB	-	1	D-52607	
			40	2.2	1.4	30	20	14	ATB	-	10	D-52607-10	
		190	24	2.2	1.4	30	-	15	ATB	EAC mark only	1	D-64951	
			40	2.2	1.4	30	-	15	ATB	EAC mark only	1	D-64967	
		210	24	2.5	1.6	25	-	15	ATB	-	1	D-72344	
			40	2.5	1.6	25	-	15	ATB	-	1	D-72350	
		235	20	2.5	1.6	25.4	25	14	ATB	-	1	D-50544	
			20	2.5	1.6	30	25	14	ATB	-	1	D-52613	
			20	2.5	1.6	30	-	14	ATB	-	10	D-52613-10	
			40	2.5	1.6	25.4	25	12	ATB	-	1	D-50550	
			40	2.5	1.6	30	25	12	ATB	-	1	D-52629	
			48	2.5	1.6	25.4	25	12	ATB	-	1	D-59128	
			48	2.5	1.6	30	-	12	ATB	-	1	D-59140	
			60	2.5	1.6	25.4	25	12	ATB	-	1	D-50566	
		60	2.5	1.6	30	25	12	ATB	-	1	D-52635		
		Wood,MDF	165	52	2.2	1.4	20	15.88	-5	TCG	-	1	D-62474
			185	60	2.2	1.4	20	15.88	-5	TCG	-	1	D-61466
		60		2.2	1.4	20	15.88	-5	TCG	-	10	D-61466-10	

TCT Saw Blade for Circular Saw Wood assortment General



Range	Work Material	Outer dia. mm	No. teeth	Kerf mm	Plate mm	Hole dia. mm	Ring mm	Rake	Tooth shape	Note	Sales Pkg Qty	Part No.
★★★★★	Wood	165	16, 24, 40	2	1.3	20	-	20, 20, 18	ATB	TRIPLE-PACK (D-09628&D-03333&D-03349)	3	D-44753
			16, 20	2	1.3	30	16, 20	20	ATB	TWIN-PACK (D-03903&D-09634)	2	D-20052
		185	16, 24, 40	1.8, 1.8, 2.0	1.2, 1.2, 1.3	20	-	20, 20, 18	ATB	TRIPLE-PACK (D-34338&D-19037&D-17843)	3	D-34285
			16, 24, 40	2	1.3	30	-	20, 20, 18	ATB	TRIPLE-PACK (D-03903&D-09634&D-03919)	3	D-44769
			20, 40	2	1.3	30	16, 20	20, 18	ATB	TWIN-PACK (D-03919&D-09634)	2	D-21593
			24, 40	1.8, 2	1.2, 1.3	20	-	20, 18	ATB	TWIN-PACK (D-19037&D-03361)	2	D-21412
			24, 40	1.8, 2	1.2, 1.3	20	-	20, 18	ATB	TWIN-PACK (D-19037&D-17843)	2	D-19043
			24, 40	1.8, 2.2	1.2, 1.5	20	-	20, 5	ATB	TWIN-PACK (D-19037&D-21375)	2	D-21397
			24, 60	1.8, 2.4	1.2, 1.6	20	-	20, 12	ATB	TWIN-PACK (D-19037&D-21381)	2	D-21406
			235	20, 48	2.4	1.6	30	25, 25.4	18, 20	ATB	TWIN-PACK (D-03925&D-03931)	2
		20, 48		2.4	1.6	30	25, 25.4	20, 18	ATB	TWIN-PACK (D-03931&D-03925)	2	D-21602
		20, 48, 60		2.4	1.6	30	-	20, 18, 15	ATB	TRIPLE-PACK (D-03925&D-03931&D-09640)	3	D-44775
		24, 40		2.4	1.6	25	-	20, 18	ATB	TWIN-PACK (D-19825&D-19819)	2	D-21319

TCT Saw Blade for Circular Saw Wood with nails Tip embedded General



Range	Work Material	Outer dia. mm	No. teeth	Kerf mm	Plate mm	Hole dia. mm	Ring mm(inch)	Rake	Tooth shape	Sales Pkg Qty	Part No.
★★★★☆	Wood/NAIL	165	16	2	1.25	20	-	23	ATB	1	A-86022
			24	2	1.25	20	-	23	ATB	1	A-86038
			40	2	1.25	20	-	18	ATB	1	A-86044
		185	16	2	1.25	30	20(13/16)	25	ATB	1	A-86050
			20	1.85	1.25	20	-	25	ATB	1	A-83814
			20	2	1.25	30	20(13/16)	25	ATB	1	A-86066
40	2	1.25	30	20(13/16)	25	ATB	1	A-86072			

TCT Saw Blade for Circular Saw Wood and Metal General



Range	Work Material	Outer dia. mm	No. teeth	Kerf mm	Plate mm	Hole dia. mm	Ring mm(inch)	Rake	Tooth shape	Sales Pkg Qty	Part No.
★★★★☆	Wood, Metal	160	42	2.8	2	20	16(5/8)	-5	TCG	1	A-02624
		180	48	2.8	2	20	16(5/8)	-5	TCG	1	A-02630
		210	54	2.8	2	30	25(1)	-5	TCG	1	A-02646
		235	54	3	2.2	30	25(1)	-5	TCG	1	A-02652

TCT Saw Blade for Plunge Cut Saw Wood General



Range	Work Material	Outer dia. mm	No. teeth	Kerf mm	Plate mm	Hole dia. mm	Rake	Tooth shape	Note	Sales Pkg Qty	Part No.
★★★★☆	Wood, MDF	165	60	2	1.4	20	5	Hi-ATB	Fluorine coating, Laser slit	1	B-56661
			60	2	1.4	20	5	TCG	Fluorine coating, Laser slit	1	B-56677
★★★★☆	Wood		28	2	1.4	20	15	ATB	-	1	B-56649
			28	2.2	1.6	20	15	ATB	-	1	B-07434
			48	1.85	1.25	20	8	ATB	-	1	B-56166
			48	2.2	1.6	20	8	ATB	-	1	B-07353

TCT Saw Blade for Miter Saw Table Saw Wood General



Range	Work Material	Outer dia. mm	No. teeth	Kerf mm	Plate mm	Hole dia. mm	Ring mm(inch)	Rake	Tooth shape	Note	Sales Pkg Qty	Part No.	
★★★★☆	Wood	165	64	1.9	1.4	20	-	10	ATAF	-	1	B-56487	
			24	2	1.4	20	-	-5	ATB	-	1	B-03866	
		190	24	2.2	1.6	20	-	5	ATB	-	1	B-03850	
			24	2.2	1.6	20	-	5	ATB	-	1	B-04298	
			24	2.2	1.6	20	-	5	ATB	-	1	B-04880	
			40	1.9	1.4	20	-	10	ATB	-	1	A-86147	
			40	2	1.4	20	-	10	ATAF	-	1	A-86751	
			60	2	1.4	20	-	-5	ATB	-	1	B-03981	
			60	2	1.4	20	-	5	ATB	-	1	B-04008	
			72	2	1.4	20	-	10	ATAF	-	1	A-86359	
			203	24	2.4	1.6	25.4	-	25	ATB	-	1	A-81941
				30	2.4	1.6	25.4	25(1)	25	ATB	-	1	A-81957
		36		2.4	1.6	25.4	-	20	ATAF	-	1	A-81963	
		40		2	1.4	25.4	25(1)	20	ATAF	-	1	A-82498	
		40		2.4	1.6	25.4	25(1)	20	ATAF	-	1	A-81430	
		48		2.4	1.6	25.4	25(1)	20	ATAF	-	1	A-81979	
		60		2	1.4	25.4	25(1)	15	ATAF	-	1	A-82507	
		60		2.2	1.6	25.4	25(1)	15	ATAF	-	1	A-82703	
		210	60	2.4	1.6	25.4	25(1)	15	ATAF	-	1	A-81446	
			80	2.4	1.6	25.4	25(1)	15	ATB	-	1	A-81452	
			18	1.9	1.4	30	25(1)	25	ATB	-	1	A-81767	
			18	2	1.4	25	-	20	FTG	-	1	792345-7	
			24	1.9	1.4	30	25(1)	23	ATB	-	1	A-81773	
			48	1.9	1.4	30	25(1)	8	ATAF	-	1	A-81789	
			80	2	1.4	25	-	8	FTG	-	1	792438-0	
			216	40	2.1	1.6	25.4	25(1)	10	ATB	-	1	A-86153
		40		2.1	1.6	30	-	10	ATB	-	1	A-86169	
		48		2.4	1.6	25.4	-	5	ATAF	-	1	B-39497	
		80		2.2	1.6	25.4	-	10	ATAF	-	1	B-45593	
		100		2.2	1.6	25.4	-	10	ATAF	-	1	B-51390	

Range	Work Material	Outer dia. mm	No. teeth	Kerf mm	Plate mm	Hole dia. mm	Ring mm(inch)	Rake	Tooth shape	Note	Sales Pkg Qty	Part No.	
★★★★☆	Wood	255	24	2.3	1.6	25.4	-	20	ATB	-	1	B-05000	
			24	2.4	1.8	25.4	25(1)	25	ATAF	-	1	A-82513	
			24	2.4	1.8	25.4	-	25	ATAF	-	1	A-87890	
			24	3.2	2.2	25.4	25(1)	25	ATB	-	1	A-82024	
			30	3.2	2.2	25.4	25(1)	25	ATB	-	1	A-82030	
			32	2.3	1.8	25.4	-	5	ATAF	-	1	A-83696	
			32	2.3	1.8	30	15.88(5/8)	5	ATAF	-	1	A-80961	
			36	3.2	2.2	25.4	-	25	ATB	-	1	A-82046	
			40	2.2	1.7	30	-	10	ATAF	-	1	B-10338	
			40	2.3	1.6	25.4	-	20	ATB	-	1	B-05088	
			40	2.3	1.8	25.4	-	5	ATB	-	1	B-03626	
			40	2.3	1.8	25.4	-	5	ATB	-	1	B-03707	
			40	2.4	1.8	25.4	25(1)	20	ATAF	-	1	A-82529	
			40	2.8	2	25.4	25(1)	25	ATB	-	1	A-81496	
			40	3.2	2.2	25.4	25(1)	25	ATB	-	1	A-82725	
			48	3.2	2.2	25.4	25(1)	20	ATAF	-	1	A-82052	
			50	2.3	1.8	30	15.88(5/8)	15	ATAF	-	1	A-80977	
			60	2.3	1.8	25.4	-	5	ATB	-	1	B-03632	
			60	2.3	1.8	25.4	-	5	ATB	-	1	B-03713	
			60	2.3	1.8	25.4	-	5	ATB	-	1	B-53665	
			60	2.8	2	25.4	25(1)	20	ATAF	-	1	A-81505	
			80	2.3	1.8	25.4	-	10	ATAF	-	1	B-45624	
			80	2.3	1.8	25.4	-	5	ATB	-	1	B-03648	
			80	2.3	1.8	25.4	-	5	ATB	-	1	B-03729	
			80	2.8	2	25.4	25(1)	15	ATAF	-	1	A-82286	
		80	2.8	2	25.4	25(1)	15	ATB	-	1	A-81511		
		100	2.3	1.8	25.4	-	10	ATAF	-	1	B-45630		
		100	2.3	1.8	25.4	-	5	ATB	-	1	B-03735		
		100	2.6	2	25.4	25(1)	15	ATAF	-	1	A-82292		
		120	2.3	1.8	25.4	-	10	ATAF	-	1	B-45646		
		120	2.6	2	25.4	25(1)	15	ATAF	-	1	A-82301		
		260	24	2.3	1.6	30	-	20	ATB	-	1	B-04999	
			40	2.3	1.6	30	-	20	ATB	-	1	B-05072	
			40	2.3	1.8	30	15.88(5/8)	5	ATB	-	1	B-03545	
			60	2.3	1.8	30	15.88(5/8)	5	ATAF	-	1	A-85014	
			60	2.3	1.8	30	15.88(5/8)	5	ATAF	-	1	B-11019	
			60	2.3	1.8	30	15.88(5/8)	5	ATB	-	1	B-03486	
			64	2.3	1.8	25	-	5	ATAF	-	1	792695-0	
			70	2.3	1.8	30	15.88(5/8)	5	ATAF	-	1	B-04597	
			80	2.3	1.8	30	15.88(5/8)	5	ATB	-	1	B-03551	
			100	2.3	1.8	30	15.88(5/8)	5	ATB	-	1	B-03567	
			305	30	3.4	2.4	25.4	25(1)	25	ATAF	-	1	A-82068
				36	3.4	2.4	25.4	25(1)	25	ATB	-	1	A-82074
				40	2.3	1.8	25.4	-	5	ATB	-	1	B-03741
				40	2.3	1.8	30	15.88(5/8)	5	ATB	-	1	B-03573
				40	3.4	2.4	25.4	25(1)	25	ATB	-	1	A-82080
		48		3.4	2.4	25.4	25(1)	20	ATB	-	1	A-82096	
		60		2.3	1.8	25.4	-	5	ATAF	-	1	B-02808	
		60		2.3	1.8	25.4	-	5	ATB	-	1	B-03676	
		60		2.3	1.8	25.4	-	5	ATB	-	1	B-03757	
		60		2.3	1.8	30	15.88(5/8)	5	ATB	-	1	B-03589	
		60		2.6	2	25.4	-	10	ATAF	-	1	A-85472	
		60		2.6	2	30	15.88(5/8)	10	ATAF	-	1	B-03822	
		60		2.6	2	30	-	-5	ATAF	-	1	B-03844	
		60		3	2	25.4	25(1)	20	ATAF	-	1	A-82105	
		70		2.5	1.9	25.4	-	0	ATAF	-	1	B-57560	
		70		2.5	1.9	30	15.88(5/8)	0	ATAF	-	1	B-04606	
		80		2.3	1.8	25.4	-	5	ATB	-	1	B-03763	
		80		2.3	1.8	30	15.88(5/8)	5	ATB	-	1	B-03595	
		80		3.2	2.2	25.4	25(1)	15	ATAF	-	1	A-82317	
		96		2.3	1.8	25.4	-	5	ATAF	-	1	B-02814	
		96		2.3	1.8	30	15.88(5/8)	-5	ATAF	-	1	B-04014	
		100		2.3	1.8	25.4	-	10	ATAF	-	1	B-45652	
		100		2.3	1.8	25.4	-	5	ATB	-	1	B-03698	
		100		2.3	1.8	25.4	-	5	ATB	-	1	B-03779	
		100		2.3	1.8	30	15.88(5/8)	5	ATB	-	1	B-03604	
		100	3	2.2	25.4	25(1)	15	ATAF	-	1	A-82323		
		120	2.3	1.8	25.4	-	10	ATAF	-	1	B-45668		
		120	3	2.2	25.4	25(1)	15	ATAF	-	1	A-82339		
		355	30	3.6	2.6	25.4	25(1)	25	ATB	-	1	A-82111	
			36	3.6	2.6	25.4	25(1)	25	ATB	-	1	A-82127	
			40	3.6	2.6	25.4	25(1)	25	ATB	-	1	A-82133	
			48	3.4	2.4	25.4	25(1)	25	ATAF	-	1	A-81527	
			48	3.6	2.6	25.4	25(1)	25	ATB	-	1	A-82731	
			60	2.6	2	25.4	-	10	ATB	-	1	A-85488	
			60	3	2.2	25	-	20	ATB	-	1	A-02618	
			60	3.4	2.4	25.4	25(1)	20	ATAF	-	1	A-82149	
			80	3	2.2	30	-	5	ATB	-	1	B-04282	
			80	3.4	2.4	25.4	25(1)	15	ATAF	-	1	A-82345	
		80	3.4	2.4	25.4	25(1)	20	ATAF	-	1	A-81533		
		100	3.4	2.4	25.4	25(1)	15	ATAF	-	1	A-82351		

Range	Work Material	Outer dia. mm	No. teeth	Kerf mm	Plate mm	Hole dia. mm	Ring mm(inch)	Rake	Tooth shape	Note	Sales Pkg Qty	Part No.		
★★★★☆	Wood	355	100	3.4	2.4	25.4	-	15	ATB	-	1	A-81549		
		355	120	3.4	2.4	25.4	25(1)	15	ATAF	-	1	A-82367		
		405	30	3.8	2.6	25.4	25(1)	25	ATAF	-	1	A-82155		
			36	3.6	2.6	25.4	-	25	ATAF	-	1	A-82161		
			40	3.6	2.6	25.4	25(1)	25	ATAF	-	1	A-82177		
			48	3.6	2.6	25.4	-	25	ATB	-	1	A-81555		
			60	3.4	2.4	25.4	25(1)	20	ATAF	-	1	A-82183		
			80	3.6	2.6	25.4	25(1)	20	ATAF	-	1	A-81561		
			100	3.6	2.6	25.4	25(1)	15	ATAF	-	1	A-82395		
			120	3.6	2.6	25.4	25(1)	15	ATAF	-	1	A-81577		
		510	120	3.6	2.6	25.4	25(1)	15	ATAF	-	1	A-82404		
			52	4.2	3	25.4	-	25	ATB	-	1	A-81583		
			80	4.2	3	25.4	-	20	ATAF	-	1	A-81599		
		★★★☆☆	Wood,MDF	255	80	2.6	1.8	30	25.4	12	ATB	-	1	D-34388
					60	2.4	1.8	30	-	15	ATB	-	1	D-46408
100	2.6				2	25.4	15.88	12	ATB	-	1	D-34394		
305	100			3.2	2.4	25.4	-	15	ATB	-	1	D-34403		
	84			2.6	1.8	25.4	-	-5	TCG	-	1	D-62452		
	100			3	2	30	15.88	12	ATB	-	1	D-38940		
	100			3.2	2.4	30	15.88	10	TCG	-	1	D-19071		
	96			3.2	2.2	25.4	-	-5	TCG	-	1	D-62468		
	120			3.2	2.2	30	15.88	12	ATB	-	1	D-38956		
	120			3.2	2.4	30	15.88	10	TCG	-	1	D-19087		
★★★★☆	Wood	255	40	2.6	1.8	25.4	-	15	ATB	-	1	D-74055		
			40	2.6	1.8	25.4	-	15	ATB	-	1	D-74061		
			40	2.6	1.8	25.4	-	15	ATB	EAC mark only	1	D-65414		
		260	40	2.6	1.8	30	-	15	ATB	EAC mark only	1	D-65377		
			60	2.6	1.8	25.4	-	15	ATB	-	1	D-65420		
			60	2.6	1.8	30	-	15	ATB	EAC mark only	1	D-65383		
			80	2.6	1.8	25.4	-	12	ATB	-	1	D-65436		
			80	2.6	1.8	30	-	12	ATB	EAC mark only	1	D-65399		
			100	2.6	1.8	25.4	-	12	ATB	-	1	D-65442		
			100	2.6	1.8	30	-	12	ATB	EAC mark only	1	D-65408		
		305	60	2.8	2	25.4	-	15	ATB	-	1	D-72366		
			80	2.8	2	25.4	-	15	ATB	-	1	D-72372		
			100	2.8	2	25.4	-	15	ATB	-	1	D-72388		
		Wood,MDF	255	100	2.8	1.8	25.4	15.88	10	TCG	-	1	D-72279	
				100	3	2	30	25.4	12	TCG	-	1	D-57130	
			260	84	2.8	1.8	25.4	-	10	TCG	-	1	D-62480	
				84	2.8	1.8	25.4	15.88	10	TCG	-	1	D-72285	
				305	96	3	2	25.4	-	10	TCG	-	1	D-62496

TCT Saw Blade for Miter Saw Table Saw Wood and Metal General



Range	Work Material	Outer dia. mm	No. teeth	Kerf mm	Plate mm	Hole dia. mm	Ring mm(inch)	Rake	Tooth shape	Sales Pkg Qty	Part No.
★★★★☆	Wood,Metal	255	80	3.2	2.4	30	25(1)	-5	TCG	1	A-02668

TCT Saw Blade for Plate Joiner Wood General



Range	Work Material	Outer dia. mm	No. teeth	Kerf mm	Plate mm	Hole dia. mm	Rake	Tooth shape	Sales Pkg Qty	Part No.
★★★★☆	Wood	100	6	4	3	22	20	ATAF	1	B-20644

TCT Saw Blade for Metal Cutting Metal General



Range	Work Material	Outer dia. mm	No. teeth	Kerf mm	Plate mm	Hole dia. mm	Rake	Tooth shape	Note	Sales Pkg Qty	Part No.	
★★★★☆	Metal	150	32	1.1	0.95	20	0	TCG	Laser slit	1	B-68301	
		136	30	1.5	1.2	20	0	MTCG	-	1	B-07319	
			50	1.4	1.1	20	-15	ATB	-	1	B-07325	
		150	32	1.5	1.2	20	0	MTCG	-	1	B-46296	
			52	1.4	1.1	20	-15	ATB	-	1	B-47008	
		185	36	1.9	1.5	20	0	ATB	-	1	B-04628	
			36	1.9	1.5	30	0	ATB	-	1	B-03931	
			38	1.4	1.2	20	0	TCG	Laser slit	1	E-14320	
			38	2	1.6	20	0	MTCG	-	1	A-85438	
			38	2	1.6	30	0	MTCG	-	1	B-03953	
			48	1.85	1.5	20	0	SMTCCG	-	1	B-23357	
		★★★★☆	Metal	48	2	1.6	20	0	MTCG	-	1	A-83967
				48	2	1.6	30	0	MTCG	-	1	B-03969
				56	1.8	1.4	30	-10	FTG	-	1	B-07369
	56			1.8	1.5	20	0	SMTCCG	-	1	B-23391	
	70			1.7	1.3	20	-10	FTG	-	1	A-86446	
	70			1.7	1.3	30	-10	FTG	-	1	B-03975	
	Metal,SUS	Metal,SUS	60	2.1	1.7	25.4	0	TCG	-	1	A-87242	
			305	60	2.4	2	25.4	0	TCG	Laser slit	1	A-86723
				60	2.5	2.2	25.4	0	TCG	-	1	A-81860
78			2.3	2	25.4	0	MTCG	Laser slit	1	A-87127		
136			56	1.1	0.95	20	0	FTG	Laser slit	1	B-23117	
150			60	1.1	1	20	0	SMTCCG	Laser slit	1	B-47014	
185	64	1.6	1.3	20	0	FTG	-	1	B-31697			
305	100	1.95	1.65	25.4	-3	SMTCCG	-	1	B-23151			

TCT Saw Blade for Circular Saw Aluminum General



Range	Work Material	Outer dia. mm	No. teeth	Kerf mm	Plate mm	Hole dia. mm	Rake	Tooth shape	Sales Pkg Qty	Part No.
★☆☆☆☆	Aluminum	185	60	2.2	1.4	20	5	TCG	1	D-73047
		210	60	2.4	1.6	25	5	TCG	1	D-73053
		235	80	2.4	1.6	25	5	TCG	1	D-73069

TCT Saw Blade for Plunge Cut Saw Aluminum General



Range	Work Material	Outer dia. mm	No. teeth	Kerf mm	Plate mm	Hole dia. mm	Rake	Tooth shape	Sales Pkg Qty	Part No.
★★★★☆	Aluminum	165	56	2	1.4	20	-3	TCG	1	B-56655
			56	2.4	1.7	20	-3	TCG	1	B-07440

TCT Saw Blade for Metal Cutting Aluminum General



Range	Work Material	Outer dia. mm	No. teeth	Kerf mm	Plate mm	Hole dia. mm	Ring mm	Rake	Tooth shape	Sales Pkg Qty	Part No.
★★★★☆	Aluminum	136	50	1.6	1	20	-	0	ATB	1	B-40331
		150	52	1.6	1	20	-	0	ATB	1	B-47020
★☆☆☆☆	Aluminum	185	40	2.2	1.4	20	15.88	5	TCG	1	D-62119
		185	40	2.2	1.4	30	-	5	TCG	1	D-62103

TCT Saw Blade for Miter Saw Table Saw Aluminum General



Range	Work Material	Outer dia. mm	No. teeth	Kerf mm	Plate mm	Hole dia. mm	Ring mm(inch)	Rake	Tooth shape	Note	Sales Pkg Qty	Part No.	
★★★☆☆	Aluminum	165	60	1.8	1.2	20	-	5	TCG	Laser slit	1	B-56530	
		190	60	2	1.4	20	-	-5	TCG	-	1	B-03997	
		80	2.6	2	25.4	25(1)	0	ATB	-	1	A-82535		
		255	100	2.3	1.8	25.4	25(1)	-5	TCG	-	1	B-04204	
			100	2.4	1.8	25.4	-	0	ATB	-	1	B-45696	
			100	2.4	1.8	25.4	-	-5	TCG	-	1	B-45674	
			100	2.6	2	25.4	25(1)	0	ATB	-	1	A-81614	
			120	2.6	2	25.4	25(1)	0	ATB	-	1	A-81620	
			80	2.3	1.8	30	15.88(5/8)	-5	FTG	-	1	B-04151	
		260	100	2.3	1.8	30	15.88(5/8)	-5	TCG	-	1	B-04167	
			80	2.3	1.8	30	15.88(5/8)	-5	TCG	-	1	B-04173	
		305	80	2.8	2.2	25.4	25(1)	0	ATB	-	1	A-82541	
			100	2.3	1.8	30	15.88(5/8)	-5	TCG	-	1	B-04020	
			100	2.3	1.8	30	15.88(5/8)	-5	TCG	-	1	B-04189	
			100	2.4	1.8	25.4	-	5	FTG	-	1	B-02820	
			100	2.6	2	25.4	-	0	ATB	-	1	B-45705	
			100	2.6	2	25.4	-	-5	TCG	-	1	B-45680	
			100	2.8	2.2	25.4	25(1)	0	ATB	-	1	A-82557	
			120	2.8	2.2	25.4	-	0	ATB	-	1	A-82563	
		355	80	3	2.2	25	-	5	TCG	-	1	A-02602	
			80	3	2.4	25.4	25(1)	0	ATB	-	1	A-82579	
			100	3	2.4	25.4	25(1)	0	ATB	-	1	A-81636	
			120	3	2.4	25.4	25(1)	0	ATB	-	1	A-81642	
		380	100	3	2.4	25.4	-	0	ATB	-	1	A-82585	
		405	100	3.4	2.6	25.4	25(1)	0	ATB	-	1	A-82600	
			120	3.4	2.6	25.4	25(1)	0	ATB	-	1	A-82616	
		★★☆☆☆	260	70	3	2	25.4	-	5	TCG	-	1	D-03408
				70	3	2	30	15.88	5	TCG	-	1	D-03969
				100	2.8	2	30	15.88	-3	TCG	-	1	D-26674
				100	3	2	25.4	-	5	TCG	-	1	D-03414
				100	3	2	30	15.88	5	TCG	-	1	D-03975
				80	3	2.2	30	15.88	5	TCG	-	1	D-16520
100	3			2	25.4	15.88	5	TCG	-	1	D-34419		
120	3.3			2.35	30	25	8	TCG	-	1	D-16592		
★☆☆☆☆	260	70	2.8	1.8	25.4	-	5	TCG	-	1	D-73075		
		100	2.6	1.8	25.4	-	5	TCG	-	1	D-59162		
		100	2.6	1.8	30	-	5	TCG	-	1	D-61874		
		120	2.6	1.8	25.4	-	5	TCG	-	1	D-61058		
		120	2.6	1.8	30	-	5	TCG	-	1	D-61880		
		80	2.8	2	25.4	-	5	TCG	-	1	D-73081		
305	100	2.8	2	25.4	-	5	TCG	-	1	D-73097			

TCT Saw Blade for Circular Saw Multi-purpose General



Range	Work Material	Outer dia. mm	No. teeth	Kerf mm	Plate mm	Hole dia. mm	Ring mm	Rake	Tooth shape	Sales Pkg Qty	Part No.
★★☆☆☆	Multi-purpose	160	60	2.2	1.4	30	15.88, 16, 19, 20	5	TCG	1	D-63600
		165	60	2.2	1.4	30	15.88, 16, 19, 20	5	TCG	1	D-63616
		185	60	2.2	1.4	30	15.88, 16, 20	5	TCG	1	D-63622
		190	60	2.2	1.4	30	15.88, 16, 20	5	TCG	1	D-63638
		210	60	2.4	1.6	30	16, 20, 25, 25.4	5	TCG	1	D-63644
		235	60	2.4	1.6	30	16, 20, 25, 25.4	5	TCG	1	D-63557

TCT Saw Blade for Plunge Cut Saw Solid Surface material General



Range	Work Material	Outer dia. mm	No. teeth	Kerf mm	Plate mm	Hole dia. mm	Rake	Tooth shape	Sales Pkg Qty	Part No.
★★★☆☆	Corian	165	48	2	1.4	20	5	TCG	1	B-56683
			48	2.4	1.7	20	5	TCG	1	B-10344

TCT Saw Blade for Miter Saw Table Saw Multi-purpose General



Range	Work Material	Outer dia. mm	No. teeth	Kerf mm	Plate mm	Hole dia. mm	Ring mm	Rake	Tooth shape	Sales Pkg Qty	Part No.
★★★★★	Multi-purpose	216	60	2.4	1.6	30	16, 20, 25, 25.4	5	TCG	1	D-63650
			80	2.4	1.6	30	16, 20, 25, 25.4	5	TCG	1	D-63878
		260	80	2.6	1.8	30	16, 20, 25, 25.4	5	TCG	1	D-63563
			100	2.6	1.8	30	16, 20, 25, 25.4	5	TCG	1	D-62234
			120	2.6	1.8	30	16, 20, 25, 25.4	5	TCG	1	D-62240
		305	80	2.8	2	30	16, 20, 25, 25.4	5	TCG	1	D-63579
			100	2.8	2	30	16, 20, 25, 25.4	5	TCG	1	D-63585
			120	2.8	2	30	16, 20, 25, 25.4	5	TCG	1	D-63591
		355	100	3	2.2	30	16, 20, 25, 25.4	5	TCG	1	D-63884

TCT Saw Blade for Plunge Cut Saw Sandwich panel General



Range	Work Material	Outer dia. mm	No. teeth	Kerf mm	Plate mm	Hole dia. mm	Rake	Tooth shape	Sales Pkg Qty	Part No.
★★★★☆	Sandwichpanel	165	42	1.75	1.4	20	0	SMTCG	1	B-63161

TCT Saw Blade for Aluminum Groove Cutter General



Range	Work Material	Outer dia. mm	No. teeth	Kerf mm	Plate mm	Hole dia. mm	Rake	Tooth shape	Note	Sales Pkg Qty	Part No.
Specialized	Aluminum composite panel	118	6	14	6	20	5	TCG	Grooving 90 degrees	1	B-48832
			6	18	6	20	5	TCG	Grooving 135 degrees	1	B-48860

PCD Saw Blade for Circular Saw Fiber cement General



Range	Work Material	Outer dia. mm	No. teeth	Kerf mm	Plate mm	Hole dia. mm	Ring mm	Rake	Tooth shape	Sales Pkg Qty	Part No.
★★★★☆	Fiber Cement Board	165	4	1.8	1.4	20	15.88	12	FTG	1	D-72104
			4	1.8	1.4	20	-	12	FTG	1	D-72067
			4	1.8	1.4	20	15.88	12	FTG	1	D-72110

TCT Saw Blade for Steel Rod Cutter EFFICUT Metal General



Range	Work Material	Outer dia. mm	No. teeth	Kerf mm	Plate mm	Hole dia. mm	Rake	Tooth shape	Note	Sales Pkg Qty	Part No.
★★★★★	Steel rod, Thread rod	110	24	1.5	1.1	34	0	SMTCG	EAC mark only	1	E-11097

Tungsten carbide grit blade for Cordless Compact Cut-off



Range	Work Material	Outer dia. mm(inch)	No. teeth	Hole dia. mm(inch)	Sales Pkg Qty	Part No.
Specialized	Plaster board, PVC, Epoxy	76(3)	TC grit 40/50	9.5(3/8)	1	D-75596
		76	TC grit 40/50	10	1	D-74837

Tungsten carbide grit blade for angle grinder



Range	Work Material	Outer dia. mm	No. teeth	Hole dia. mm	Sales Pkg Qty	Part No.
Specialized	Plaster board, PVC, Epoxy	115	TC grit 30/40	22.23	1	B-57716
		125	TC grit 30/40	22.23	1	B-57722

Tungsten carbide grit blade for angle grinder with X-lock

XLOCK



Range	Work Material	Outer dia. mm	No. teeth	Hole dia. mm	Sales Pkg Qty	Part No.
Specialized	Plaster board, PVC, Epoxy	115	TC grit 30/40	X-LOCK	1	E-11760
		125	TC grit 30/40	X-LOCK	1	E-11776

ACCESSORIES

▣ Jigsaw / Reciprosawing



Metal, mild steel



Stainless steel



Aluminum



Wood



Wood with nails



Cork



Chipboard



Laminate board



Leather



Cardboard



Soft brick



Fiber cement board



Aerated concrete



Cast iron



Rubber



Ice



Plaster board



Plastic



Fiberglass



Raker



Wave



Wave cut knife



Japanese teeth



Sharp edge



Makita Shank jig Saw Blade



Bayonet Shank jig Saw Blade

Jig Saw blade

Teeth Type

Milled and side set teeth



Ground and side set teeth



Milled and wavy set teeth



Ground and taper ground teeth

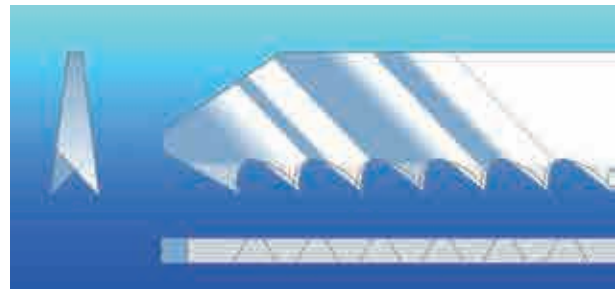

Teeth manufacture

Milled teeth

- Low cost type of manufacturing
- For general cutting
- Soft to hard materials
- Long blade life



Ground teeth

- Costly type of manufacturing
- Very sharp!
- Accurate, clean cut
- Soft to medium hard materials

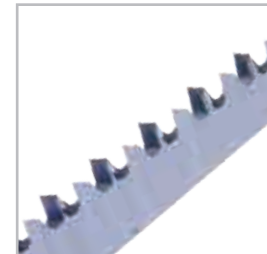

Production method

- **Side set:** each individual tooth is alternately bent to the left and to the right. Raker setting
Example: right, left, straight, etc.
- **Wavy set:** row of teeth receives a wave shape
- **Ground:** blade body tapers to the rear (conical)

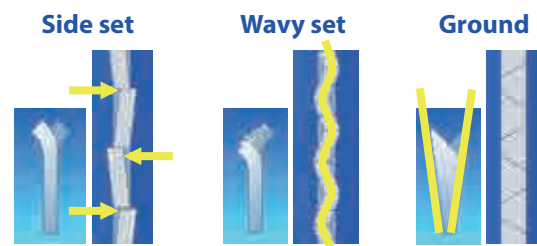

Jig Saw Blade material

- **HCS (High Carbon Steel)** for cutting softer materials such as wood or plastics.
- **HSS (High Speed Steel)** for cutting harder materials such as metals.
- **BiM (Bi-metal, HCS base and HSS teeth)** for cutting soft materials to hard materials such as wood, metal, plastics.
- **TC (Tungsten Carbide)** for cutting glass fiber reinforced plastic, cement-bonded fiberboards or plasterboard.

Jig saw blade B shank Wood Super express



Range	Makita No.	Material	Type of cut	Tooth Type	TPI	Overall Length mm	Working Length mm	Thickness mm	Material of Blade	Sales Pkg Qty	Part No.
★★★☆☆	B-50	Wood, Plastics	Fast finish	Ground and taper ground teeth	8-11	100	73	1.25	HCS	5	B-06460

Jig saw blade B shank Metal Super express



Range	Makita No.	Material	Type of cut	Tooth Type	TPI	Overall Length mm	Working Length mm	Thickness mm	Material of Blade	Sales Pkg Qty	Part No.
★★★☆☆	B-51	Metal, Stainless	Fast	Milled and wavy set teeth	10-18	100	73	0.8	HSS	5	B-06476

Jig saw blade B shank Universal Super express



Range	Makita No.	Material	Type of cut	Tooth Type	TPI	Overall Length mm	Working Length mm	Thickness mm	Material of Blade	Sales Pkg Qty	Part No.
★★★☆☆	B-52	Universal	Fast	Milled and wavy set teeth	6-10	100	73	1.0	HSS	5	B-06482

Jig saw blade B shank Wood Basic



Range	Makita No.	Material	Type of cut	Tooth Type	TPI	Overall Length mm	Working Length mm	Thickness mm	Material of Blade	Sales Pkg Qty	Part No.
★★★☆☆	B-13	Wood, Plastics	Basic	Milled and side set teeth	8	105	75	1.25	HCS	2	B-01286
										5	A-85656
	100									B-07705	
	5									A-85662	
	5									A-85678	
B-14	12	76	50	1.05	HCS	5	A-85678				
B-15	12	76	50	1.05	HCS	5	A-85678				
B-18	14	77	44	1.05	HCS	5	A-85709				
			Basic, Scroll cutting							100	B-07727

Jig saw blade B shank Wood Basic Price competitive



Range	Material	Type of cut	Tooth Type	TPI	Overall Length mm	Working Length mm	Thickness mm	Material of Blade	Sales Pkg Qty	Part No.
★★★☆☆	Wood	Basic	Milled and side set teeth	8	100	74	1.2	HCS	5	D-34877

Jig saw blade B shank Wood Fast



Range	Makita No.	Material	Type of cut	Tooth Type	TPI	Overall Length mm	Working Length mm	Thickness mm	Material of Blade	Sales Pkg Qty	Part No.							
★★★☆☆	B-16	Wood, Plastics	Fast	Ground and side set teeth	6	105	75	1.25	HCS	2	B-01292							
										5	A-85684							
										100	B-07711							
	B-16L									6	180	151	1.25	HCS	5	792726-5		
	B-17									6	105	71	1.25	HCS	2	B-01301		
																	5	A-85690
	B-8									8	105	75	1.25	HCS	5	A-85232		
	L-2									6	132	101	1.25	HCS	5	A-86309		
	No.58									8	105	75	1.25	HCS	5	A-86577		
																	100	B-07842

Jig saw blade B shank Wood Fast Price competitive



Range	Material	Type of cut	Tooth Type	TPI	Overall Length mm	Working Length mm	Thickness mm	Material of Blade	Sales Pkg Qty	Part No.
★★★★☆	Wood	Fast	Ground and side set teeth	6	100	74	1.2	HCS	5	D-34883
		Fast, Scroll cutting	Ground and side set teeth	6	100	74	1.2	HCS	5	D-34899

Jig saw blade B shank Wood Finish



Range	Makita No.	Material	Type of cut	Tooth Type	TPI	Overall Length mm	Working Length mm	Thickness mm	Material of Blade	Sales Pkg Qty	Part No.	
★★★★☆	B-10	Wood, Plastics	Fast finish	Ground and taper ground teeth	9	105	76	1.25	HCS	5	A-85628	
					100							
	B-11				9	100	73	1.25	HCS	2	B-01270	
					5							A-85634
	B-12				100							B-07680
					5							A-85640
	No.59		100							B-07696		
			5							A-86583		
	B-29		100							B-07858		
			5							A-80400		
L-1	100	Finish, Scroll cutting		16	77	44	1.05	HCS	5	A-80400		
★★★★☆	B-10S	Wood	Finish	Milled and side set teeth	6	132	100	1.25	HCS	5	A-86290	
					12	90	65	1.25	HCS	5	792691-8	
					9	105	70	1.25	HCS	5	A-85793	
	BR-13								100	B-07777		

Jig saw blade B shank Wood Finish Price competitive



Range	Material	Type of cut	Tooth Type	TPI	Overall Length mm	Working Length mm	Thickness mm	Material of Blade	Sales Pkg Qty	Part No.
★★★★☆	Wood	Finish	Ground and taper ground teeth	9	100	74	1.2	HCS	5	D-72718

Jig saw blade B shank Hardwood and Hard plastics Basic

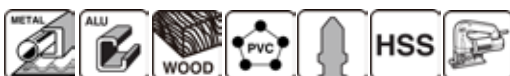

Range	Makita No.	Material	Type of cut	Tooth Type	TPI	Overall Length mm	Working Length mm	Thickness mm	Material of Blade	Sales Pkg Qty	Part No.
★★★★☆	B-25	Wood, Plastics, Aluminum, Metal	Basic	Milled and side set teeth	9	100	74	1.05	HSS	2	B-01345
										5	A-85765
	B-26		Basic, Scroll cutting	Milled and side set teeth	9	100	71	1.05	HSS	100	B-07755
										2	B-01351
									5	A-85771	

Jig saw blade B shank Decorative veneers Finish



Range	Makita No.	Material	Type of cut	Tooth Type	TPI	Overall Length mm	Working Length mm	Thickness mm	Material of Blade	Sales Pkg Qty	Part No.
★★★★☆	B-19	Wood, Plastics	Finish	Ground and taper ground teeth	12	90	63	1.25	HCS	5	A-85715
	B-28	Wood, Plastics	Finish	Ground and taper ground teeth	16	90	63	1.25	HSS	5	A-80391

Jig saw blade B shank Laminate Finish



Range	Makita No.	Material	Type of cut	Tooth Type	TPI	Overall Length mm	Working Length mm	Thickness mm	Material of Blade	Sales Pkg Qty	Part No.
★★★☆☆	B-53	Laminate, Plastics	Finish	Ground and taper ground teeth	15	82	59	1.25	Bi-Metal	5	B-10970
	B-54		Finish, Scroll cutting		18	82	59	1.25	Bi-Metal	5	B-10986
	B-55		Finish		14	100	77	1.25	Bi-Metal	5	B-31887

Jig saw blade B shank Metal Basic



Range	Makita No.	Material	Type of cut	Tooth Type	TPI	Overall Length mm	Working Length mm	Thickness mm	Material of Blade	Sales Pkg Qty	Part No.
★★★☆☆	B-22	Metal, Stainless, Plastics, Aluminum	Basic	Milled and wavy set teeth	24	76	52	0.9	HSS	2	B-01323
										5	A-85737
										100	B-07733
	B-23	Wood, Plastics, Aluminum, Metal	Basic		14	76	51	0.9	HSS	2	B-01339
										5	A-85743
	B-24	Metal, Stainless, Plastics, Aluminum	Basic		32	76	52	0.9	HSS	5	A-85759
										2	B-01367
	B-27	Metal, Stainless, Plastics, Aluminum	Basic, Scroll cutting		24	76	52	0.9	HSS	2	B-01367
										5	A-85787
	B-32	Metal, Plastics, Aluminum	Basic		18	132	107	1.25	HSS	5	B-10431
	B-33	Metal, Plastics, Aluminum	Basic		14	132	107	1.25	HSS	5	B-10447
	B-34	Metal, Stainless, Plastics, Aluminum	Basic		18	76	52	0.9	HSS	5	B-10453
	B-35	Wood with nails, Plastic, Aluminum	Basic		14	180	154	0.9	Bi-Metal	3	B-10469
5				A-86561							
No.51	Metal, Stainless, Plastics, Aluminum	Basic	24	90	66	0.9	HSS	100	B-07836		

Jig saw blade B shank Metal Basic Price competitive



Range	Material	Type of cut	Tooth Type	TPI	Overall Length mm	Working Length mm	Thickness mm	Material of Blade	Sales Pkg Qty	Part No.
★★★☆☆	Metal	Basic	Milled and wavy set teeth	21	75	51	1	HSS	5	D-34908

Jig saw blade B shank Plastics



Range	Makita No.	Material	TPI	Overall Length mm	Working Length mm	Thickness mm	Material of Blade	Sales Pkg Qty	Part No.
★★★☆☆	B-21	Plastics, Aluminum	12	100	73	1.25	HSS	2	B-01317
								5	A-85721

Jig saw blade B shank Fiber cement



Range	Makita No.	Material	TPI	Overall Length mm	Working Length mm	Thickness mm	Material of Blade	Sales Pkg Qty	Part No.
★★★☆☆	B-60	Fiber cement, Plaster board, FRP, Plastics	6	100	75	1.25	TC/HM	3	B-06890
	B-61	Fiber cement, Plaster board, FRP, Plastics	6	132	105	1.25	TC/HM	3	B-06909

Jig saw blade B shank Rubber



Range	Makita No.	Material	Overall Length mm	Working Length mm	Thickness mm	Material of Blade	Sales Pkg Qty	Part No.
★★★☆☆	B-K	Rubber, Paper, Cork, Leather	100	75	1.25	HCS	5	A-80416

Jig saw blade B shank assortment



Range	Note	Sales Pkg Qty	Part No.
★★★☆☆	2xB-13, 2xB-16, 2xB-10S, 2xB-22, 2xB-23	10	B-44410
★★★☆☆	4xB-50, 2xB-51, 2xB-52, 2xB-53	10	B-44426
★★★☆☆	2xB-50, B-51, B-52, B-53	5	B-48527
★★★☆☆	B-10S, B-13, B-16, B-22, B-23	5	A-86898
★★★☆☆	B-50, B-51, B-52	3	B-06292

Jig saw blade M shank Wood Basic



Range	Makita No.	Material	Type of cut	Tooth Type	TPI	Overall Length mm	Working Length mm	Thickness mm	Material of Blade	Sales Pkg Qty	Part No.
★★★☆☆	No.16	Wood, Plastics	Basic, Scroll cutting	Milled and side set teeth	9	82	61	1.25	HCS	2	792212-6
										5	A-85830
★★★☆☆	No.3	Wood, Plastics	Basic	Milled and side set teeth	9	80	59	1	HCS	2	A-86533
										5	A-85868
										100	B-07808

Jig saw blade M shank Wood Fast



Range	Makita No.	Material	Type of cut	Tooth Type	TPI	Overall Length mm	Working Length mm	Thickness mm	Material of Blade	Sales Pkg Qty	Part No.
★★★☆☆	No.8	Wood, Plastics	Fast	Ground and side set teeth	8	82	60	1	HCS	2	792267-1
										5	A-85911
										100	B-07814

Jig saw blade M shank Wood Finish



Range	Makita No.	Material	Type of cut	Tooth Type	TPI	Overall Length mm	Working Length mm	Thickness mm	Material of Blade	Sales Pkg Qty	Part No.
★★★☆☆	BR-3	Wood	Finish	Milled and side set teeth	9	85	58	1	HCS	5	A-85933
	No.9	Wood, Plastics	Fast finish	Ground and taper ground teeth	8	82	60	1.25	HCS	2	792325-3
										5	A-85927
	No.10	Wood, Plastics	Fast finish	Ground and taper ground teeth	9	82	60	1.25	HCS	2	792326-1
										5	A-85818
										100	B-07820
	No.10S	Wood	Finish	Ground and taper ground teeth	13	82	62	1.25	HCS	2	A-86555
										5	A-85824

Jig saw blade M shank Hardwood and Hard plastics Basic



Range	Makita No.	Material	Type of cut	Tooth Type	TPI	Overall Length mm	Working Length mm	Thickness mm	Material of Blade	Sales Pkg Qty	Part No.
★★★☆☆	No.4	Wood, Plastics, Aluminum, Metal	Basic	Milled and side set teeth	9	80	59	0.9	HSS	2	A-86549
										5	A-85874

Jig saw blade M shank Decorative veneers Basic

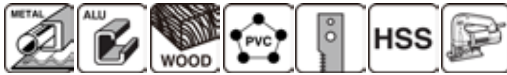

Range	Makita No.	Material	Type of cut	Tooth Type	TPI	Overall Length mm	Working Length mm	Thickness mm	Material of Blade	Sales Pkg Qty	Part No.
★★★☆☆	No.2	Wood, Plastics, Aluminum, Metal	Basic	Milled and side set teeth	14	80	60	0.9	HSS	2	A-86527
										5	A-85852
										100	B-07799
	No.17	Wood, Plastics, Aluminum, Metal	Basic, Scroll cutting	Milled and side set teeth	14	82	63	0.9	HSS	2	792215-0
										5	A-85846

Jig saw blade M shank Decorative veneers Finish



Range	Makita No.	Material	Type of cut	Tooth Type	TPI	Overall Length mm	Working Length mm	Thickness mm	Material of Blade	Sales Pkg Qty	Part No.
★★★☆☆	No.41	Wood, Plastics	Finish	Ground and taper ground teeth	12	82	61	1.25	HSS	5	A-85880
	No.42	Wood, Plastics			16	82	61	1.25	HSS	5	A-85896

Jig saw blade M shank Metal Basic



Range	Makita No.	Material	Type of cut	Tooth Type	TPI	Overall Length mm	Working Length mm	Thickness mm	Material of Blade	Sales Pkg Qty	Part No.
★★★☆☆	No.1	Metal, Stainless, Plastics, Aluminum	Basic	Milled and wavy set teeth	24	80	61	0.9	HSS	2	A-86511
										5	A-85802
										100	B-07783
	No.5	Metal, Plastics, Aluminum	Basic	Milled and wavy set teeth	24	60	40	0.9	HSS	2	792131-6
										5	A-85905

Jig saw blade M shank assortment



Range	Note	Sales Pkg Qty	Part No.
★★★☆☆	No.1, No.2, No.3, No.8, No.10S	5	A-86882

Recipro saw blade Metal Super express



Range	Material	Type of cut	Tooth Type	TPI	Overall Length mm	Working Length mm	Thickness mm	Material of Blade	Sales Pkg Qty	Part No.
★★★★☆	Metal, Plastics	Fast	Milled and side set teeth	7-18	152	130	0.9	Bi-Metal	2	B-05038-2
									5	B-05038
									25	B-05038-25

Recipro saw blade Wood Super express



Range	Material	Type of cut	Tooth Type	TPI	Overall Length mm	Working Length mm	Thickness mm	Material of Blade	Sales Pkg Qty	Part No.
★★★★☆	Wood	Fast	Milled and side set teeth	6-10	203	180	1.0	HCS	2	B-05153-2
									5	B-05153
									25	B-05153-25

Recipro saw blade Universal Super express



Range	Material	Type of cut	Tooth Type	TPI	Overall Length mm	Working Length mm	Thickness mm	Material of Blade	Sales Pkg Qty	Part No.
★★★★☆	Universal	Fast	Milled and side set teeth	6-11	152	130	0.9	Bi-Metal	2	B-05044-2
									5	B-05044
									25	B-05044-25

Recipro saw blade Metal Basic



Range	Material	Type of cut	Tooth Type	TPI	Overall Length mm	Working Length mm	Thickness mm	Material of Blade	Sales Pkg Qty	Part No.
★★★★☆	Metal	Basic	Milled and side set teeth	14	152	130	0.9	Bi-Metal	2	B-16841-2
									5	B-16841
									25	B-16841-25
				14	225	205	0.9	Bi-Metal	2	B-16776-2
									5	B-16776
									25	B-16776-25
				18	152	130	0.9	Bi-Metal	2	B-05169-2
									5	B-05169
				18	165	144	0.9	HSS	2	B-05169-25
									25	B-05169-25
				18	225	205	0.9	Bi-Metal	2	B-00810
									5	792147-1
				18	225	205	0.9	Bi-Metal	2	B-16782-2
									5	B-16782
				18	225	205	0.9	Bi-Metal	2	B-16782-25
									25	B-16782-25
				24	152	130	0.9	Bi-Metal	2	B-16835-2
									5	B-16835
				24	225	205	0.9	Bi-Metal	2	B-43169-2
	5	B-43169								
14	100	80	0.9	Bi-Metal	5	B-20410				
					5	B-20404				
18	100	80	0.9	Bi-Metal	5	B-20404				
					5	B-20395				
24	100	80	0.9	Bi-Metal	2	B-00804				
					5	792146-3				
24	125	104	0.9	HSS	2	B-00832				
					5	792149-7				
24	165	144	0.9	HSS	2	B-16857-2				
					5	B-16857				
10-14	Metal, Aluminum, Plastics	Basic	Milled and side set teeth	10-14	305	280	0.9	Bi-Metal	2	B-16857-2
									5	B-16857

Recipro saw blade Metal Basic Price competitive



Range	Material	Type of cut	Tooth Type	TPI	Overall Length mm	Working Length mm	Thickness mm	Material of Blade	Sales Pkg Qty	Part No.
★★★★☆	Metal	Basic	Milled and wavy set teeth	14	150	128	0.9	Bi-Metal	2	D-51627
					225	204	0.9		25	D-51627-25
				14	225	204	0.9	Bi-Metal	2	D-51655
									25	D-51655-25
				18	150	128	0.9	Bi-Metal	2	D-51633
									25	D-51633-25
				18	225	204	0.9	Bi-Metal	2	D-51661
									25	D-51661-25
				24	150	128	0.9	Bi-Metal	2	D-51649
									25	D-51649-25
				24	225	204	0.9	Bi-Metal	2	D-51677
									25	D-51677-25

Recipro saw blade Metal Curved shape



Range	Material	TPI	Overall Length mm	Working Length mm	Thickness mm	Material of Blade	Sales Pkg Qty	Part No.
★★★★☆	Metal	14+18	152	130	1.1	Bi-Metal	5	B-55815
			228	205	1.1	Bi-Metal	5	B-55821
			305	280	1.1	Bi-Metal	5	B-55837

Recipro saw blade Metal Heavy



Range	Material	Type of cut	Tooth Type	TPI	Overall Length mm	Working Length mm	Thickness mm	Material of Blade	Sales Pkg Qty	Part No.
★★★★☆	Metal	Heavy	Milled and side set teeth	14-18	225	205	1.1	Bi-Metal	5	B-31865
					152	130	1.1	Bi-Metal	5	B-43131
				14+18	225	205	1.1	Bi-Metal	5	B-43175
					305	280	1.1	Bi-Metal	5	B-43206
				8+10	152	130	1.1	Bi-Metal	5	B-43147
					225	205	1.1	Bi-Metal	2	B-43181-2
		Heavy fast		8+10	225	205	1.1	Bi-Metal	5	B-43181
					305	280	1.1	Bi-Metal	2	B-43212-2
				10-14	152	130	1.25	Bi-Metal	5	B-43212
					225	205	1.25	Bi-Metal	5	B-43212
					152	130	1.25	Bi-Metal	5	B-43153
					225	205	1.25	Bi-Metal	2	B-43197-2
Heavy finish	225	205	1.25	Bi-Metal	5	B-43197				
	305	280	1.25	Bi-Metal	5	B-43228				

Recipro saw blade Wood Basic



Range	Material	Type of cut	Tooth Type	TPI	Overall Length mm	Working Length mm	Thickness mm	Material of Blade	Sales Pkg Qty	Part No.
★★★★☆	Wood	Basic	Milled and side set teeth	10	150	129	1	HCS	5	A-02319
				10	152	130	0.8	HCS	5	B-16807
				10	250	229	1.25	HCS	5	B-00767
				3	152	130	1.25	HCS	5	B-16813
				6	152	130	1.25	HCS	5	B-16798
				6	305	280	1.25	HCS	2	B-16829-2
								5	B-16829	
				9	165	144	1	HCS	2	B-00826
								5	792148-9	
	Green tree, Wood		Ground and side set teeth	5	305	280	1.5	HCS	5	B-16863

Recipro saw blade Wood Basic Price competitive



Range	Material	Type of cut	Tooth Type	TPI	Overall Length mm	Working Length mm	Thickness mm	Material of Blade	Sales Pkg Qty	Part No.
★★★☆☆	Wood	Basic	Ground and side set teeth	6	150	131	1.2	HCS	2	D-53089

Recipro saw blade Wood Fast



Range	Material	Type of cut	Tooth Type	TPI	Overall Length mm	Working Length mm	Thickness mm	Material of Blade	Sales Pkg Qty	Part No.
★★★☆☆	Wood	Fast	Ground and side set teeth	6	300	279	1.25	HCS	5	B-03030
			Milled and side set teeth	4	150	129	1	HCS	5	A-02303
		Fast finish	Ground and side set teeth	6	150	129	1	HCS	5	792707-9

Recipro saw blade Wood Japanese teeth



Japanese Teeth Reciprosaw Blade

1. Japanese teeth for Sharp Edge!

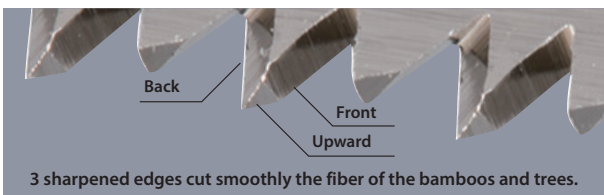

2. Clean Cutting Surface



Application

For Bamboo

15TPI



For Green Wood

8.5TPI

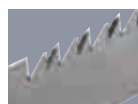

Range	Material	Tooth Type	TPI	Overall Length mm	Working Length mm	Thickness mm	Material of Blade	Note	Sales Pkg Qty	Part No.
★★★☆☆	Bamboo, Wood, Plastic	Japanese teeth	15	225	200	0.9	Bi-Metal	Bamboo: <140mm, Wood: <140mm, PVC: <140mm	1	B-57392
			15	190	165	0.6	HCS	Only use: DJR185, 183, 145, 143, JR105D, 103D, 102D, 100D, Bamboo: <100mm, Wood: <100mm, PVC: <100mm	1	B-56596
	8.5		225	200	0.9	Bi-Metal	Wood: <140mm, Green tree: <140mm	1	B-57386	
	8.5		250	225	1	HCS	Wood: <160mm, Green tree: <160mm	1	B-62016	
	8.5		190	165	0.6	HCS	Only use: DJR185, 183, 145, 143, JR105D, 103D, 102D, 100D, Wood: <100mm, Green tree: <100mm	1	B-56580	

Recipro saw blade Wood and Metal Basic



Range	Material	Type of cut	Tooth Type	TPI	Overall Length mm	Working Length mm	Thickness mm	Material of Blade	Sales Pkg Qty	Part No.
★★★☆☆	Wood with nails	Basic	Milled and side set teeth	6	100	80	0.9	Bi-Metal	2	B-20432-2
				6	152	130	1.25	Bi-Metal	5	B-20432
	Wood, Chipboard, Wood with nails, Metal, Aerated concrete, Plastics, FRP			6	152	130	1.25	Bi-Metal	2	B-05175-2
				5-8	305	280	1.25	Bi-Metal	5	B-05175
				5-8	305	280	1.25	Bi-Metal	3	B-10637

Range	Material	Type of cut	Tooth Type	TPI	Overall Length mm	Working Length mm	Thickness mm	Material of Blade	Sales Pkg Qty	Part No.
★★★★☆	Wood, Metal	Basic	Milled and side set teeth	10	100	80	0.9	Bi-Metal	5	B-20426
				14+18	100	80	0.9	Bi-Metal	5	B-20454
	Wood, Plastics, Aluminum, Metal			10-14	152	130	0.9	Bi-Metal	5	B-43240
				10-14	225	205	0.9	Bi-Metal	5	B-43262
	Wood, Wood with nails, Metal			10	152	130	0.9	Bi-Metal	2	B-31843-2
									5	B-31843
				10	200	180	0.9	Bi-Metal	200	B-54259
				10	200	180	0.9	Bi-Metal	200	B-54265
				10	225	205	0.9	Bi-Metal	2	B-31859-2
									5	B-31859
				10	225	205	0.9	Bi-Metal	200	B-54271
				10	225	205	0.9	Bi-Metal	200	B-54287

Recipro saw blade Wood and Metal Heavy



Range	Material	Type of cut	Tooth Type	TPI	Overall Length mm	Working Length mm	Thickness mm	Material of Blade	Sales Pkg Qty	Part No.
★★★★☆	Wood, Chipboard, Wood with nails, Metal, Plastics, FRP	Heavy	Milled and wavy set teeth	6-8	152	130	1.25	TC/HM	1	B-49834
									10	B-49834-10
				6-8	228	205	1.25	TC/HM	1	B-49840
									10	B-49840-10
★★★★☆	Wood, Chipboard, Metal	Heavy	Milled and side set teeth	6-8	305	280	1.25	TC/HM	1	B-49856
									10	B-49856-10
				5-8	152	130	1.6	Bi-Metal	5	B-43234
				5-8	225	205	1.6	Bi-Metal	2	B-43256-2
									5	B-43256
				5-8	305	280	1.6	Bi-Metal	2	B-43278-2
								5	B-43278	

Recipro saw blade Wood and Metal Rescue



Range	Material	Type of cut	Tooth Type	TPI	Overall Length mm	Working Length mm	Thickness mm	Material of Blade	Sales Pkg Qty	Part No.
Specialized	Wood, Chipboard, Wood with nails, Metal, Plastics, FRP	Heavy	Milled and wavy set teeth	6-8	152	130	1.25	TC/HM	25	B-67206
				6-8	225	205	1.25	TC/HM	25	B-67212

Recipro saw blade Cast iron pipes



Tungsten Carbide Tip

Application



Range	Material	TPI	Overall Length mm	Working Length mm	Thickness mm	Material of Blade	Sales Pkg Qty	Part No.	
★★★★☆	Metal, Cast iron, Stainless	8	100	80	1.25	TC/HM	1	B-55566	
								1	B-55572
			150	130	1.25	TC/HM	10	B-55572-10	
								1	B-55588
								10	B-55588-10
★★★★☆	Cast iron, FRP, Epoxy	-	305	280	1.25	TC/HM	1	B-55594	
								10	B-55594-10
			225	205	1	Diamond Grit	2	B-31871	

Recipro saw blade Stainless steel



Range	Material	TPI	Overall Length mm	Working Length mm	Thickness mm	Material of Blade	Sales Pkg Qty	Part No.
★★★☆☆	Stainless	18	152	128	1	TC/HM	2	B-07250
			203	180	1	TC/HM	2	B-51312

Recipro saw blade Fiber insulation



Range	Material	Overall Length mm	Working Length mm	Thickness mm	Material of Blade	Sales Pkg Qty	Part No.
Specialized	Fiber Insulation	228	205	1.5	HCS	2	B-52118
		305	280	1.5	HCS	2	B-52124
		400	320	1.5	HCS	1	B-52130

Recipro saw blade Plasterboard Basic



Range	Material	Type of cut	Tooth Type	TPI	Overall Length mm	Working Length mm	Thickness mm	Material of Blade	Sales Pkg Qty	Part No.
★★★☆☆	Plasterboards	Basic	Milled and side set teeth	6	100	80	0.9	Bi-Metal	5	B-20448

Recipro saw blade Ice



Range	Material	Type of cut	Tooth Type	TPI	Overall Length mm	Working Length mm	Thickness mm	Material of Blade	Sales Pkg Qty	Part No.
Specialized	Ice	Basic	Milled and side set teeth	10	228	207	1.2	Stainless steel	1	B-30570
				10	305	279	1.2	Stainless steel	1	B-23254
				3	305	280	1.25	Stainless steel	1	B-10609
		Rough		6	152	131	1.2	Stainless steel	1	B-52043
				6	228	207	1.2	Stainless steel	1	B-30564
				6	305	279	1.2	Stainless steel	1	B-23248

Recipro saw blade Aerated concrete



Range	Material	TPI	Overall Length mm	Working Length mm	Thickness mm	Material of Blade	Sales Pkg Qty	Part No.
★★★☆☆	Aerated concrete, Soft brick	2	240	202	1.5	TC/HM	1	B-12809
		2	305	267	1.5	TC/HM	1	B-10394
		2	455	420	1.5	TC/HM	1	B-10403
	Aerated concrete, Soft brick, Epoxy	2	400	375	1.5	TC/HM	2	B-63591
		3	305	280	1.5	TC/HM	2	B-63585

Recipro saw blade assortment



Range	Note	Sales Pkg Qty	Part No.
★★★☆☆	2xB-05044, 2xB-16782, 2xB-16776	6	B-44448
	2xB-16798, 2xB-05153, 2xB-05175	6	B-44432
	B-00804, B-00810, B-00826	3	792003-5
	B-05038, B-05044, B-05153	3	B-13677

Recipro saw blade Price competitive assortment



Range	Note	Sales Pkg Qty	Part No.
★★★☆☆	2xD-51627, 2xD-51633, 2xD-53089	6	D-53051

Band saw blade for 730mm Metal Wave type



Range	Length mm	Width mm	Tooth Type	Material	Material of Blade	Tpi	Note	Sales Pkg Qty	Part No.
★★★★☆	730	13	Wave set	Plastics, Non-ferrous metal, Mild steel, Cast steel and cast iron, Hard steel and stainless steel	BiM	14	Material thickness: More than 5mm	5	E-04101
					BiM	18	Material thickness: 4-5mm	5	E-04117
					BiM	24	Material thickness: Less than 4mm	5	E-04123

Band saw blade for 835mm Metal Wave type



Range	Length mm	Width mm	Tooth Type	Material	Material of Blade	Tpi	Note	Sales Pkg Qty	Part No.
★★★★☆	835	13	Wave set	Plastics, Non-ferrous metal, Mild steel, Cast steel and cast iron, Hard steel and stainless steel	BiM	14	Material thickness: More than 5mm	5	B-40543
					BiM	18	Material thickness: 4-5mm	5	B-40559
					BiM	24	Material thickness: Less than 4mm	5	B-40565

Band saw blade for 1140mm Metal Raker type



Range	Length mm	Width mm	Tooth Type	Material	Material of Blade	Tpi	Note	Sales Pkg Qty	Part No.
★★★★☆	1140	13	Raker set	Plastics, Non-ferrous metal, Mild steel	HCS	14	Material thickness: More than 5mm	3	792560-3
					HCS	18	Material thickness: 4-5mm	3	792559-8
					HCS	24	Material thickness: Less than 4mm	3	792558-0
				Plastics, Non-ferrous metal, Mild steel, Cast steel and cast iron, Hard steel and stainless steel	BiM	10	Material thickness: More than 5.5mm	1	B-30128
					BiM	14	Material thickness: More than 5mm	1	792557-2
					BiM	18	Material thickness: 4-5mm	1	792556-4

Band saw blade for 1140mm Metal Wave type



Range	Length mm	Width mm	Tooth Type	Material	Material of Blade	Tpi	Note	Sales Pkg Qty	Part No.
★★★★☆	1140	13	Wave set	Plastics, Non-ferrous metal, Mild steel, Cast steel and cast iron, Hard steel and stainless steel	BiM	14	Material thickness: More than 5mm	1	194691-8
					BiM	24	Material thickness: Less than 4mm	1	194692-6

Band saw blade for 1140mm Wood Raker type



Range	Length mm	Width mm	Tooth Type	Material	Material of Blade	Tpi	Note	Sales Pkg Qty	Part No.
★★★★☆	1140	13	Raker set	Wood	HCS	6		3	792567-9

Band saw blade for 2240mm Metal Raker type



Range	Length mm	Width mm	Tooth Type	Material	Material of Blade	Tpi	Note	Sales Pkg Qty	Part No.
★★★★☆	2240	16	Raker set	Non-ferrous metal	HCS	14	Material thickness: More than 5mm	3	B-16695

Band saw blade for 2240mm Wood Raker type



Range	Length mm	Width mm	Tooth Type	Material	Material of Blade	Tpi	Note	Sales Pkg Qty	Part No.
★★★★☆	2240	6	Raker set	Wood for curve cut	HCS	6		3	B-16689
		13		Wood for universal cut	HCS	4		3	B-16673
		16		Wood for cross cut	HCS	4		3	B-16667

ACCESSORIES

▣ Brushing



Hook and loop
type



6mm
6mm cylindrical
shank.

Brushes for Grinder

Shape type

For Grinder

Cup	Effective for flat or rugged surface.
Standard	With metal cover Keep high works effectively.

Wheel	Effective for working at spot.
--------------	--------------------------------

Bevel	Effective for working at corner.
--------------	----------------------------------

For Drill

Cup	Effective for flat or rugged surface.
------------	---------------------------------------

Wheel	Effective for working at spot.
--------------	--------------------------------

End	Effective for tight or narrow place.
------------	--------------------------------------

Flap	Effective for treatment for wood.
-------------	-----------------------------------

Material of Brush

Steel	Ideal for metal material.
--------------	---------------------------

Steel (Brass coated)	Ideal for metal material. Feature of wire is resistant to rust.
-----------------------------	-----------------------------------------------------------------

Stainless	Ideal for stainless material. Feature of wire is resistant to rust, heat and corrosion.
------------------	-----------------------------------------------------------------------------------------

Nylon*	Ideal for light rust removal of metal material, wood and PVC.
---------------	---------------------------------------------------------------

*For driver drill only

Wire type

Crimped	Ideal for light rust removal.
----------------	-------------------------------

Knotted	Ideal for heavy work.
----------------	-----------------------

Trim materials of Brushes for Grinder and Drill

Material of Brush	Steel wire		Steel wire (Brass coated)	Stainless wire		Nylon wire	
	Knotted	Crimped	Crimped	Knotted	Crimped	Coarse(#80)	Fine(#240)
Image							
Work efficiency	Very high	High	High	Very high	High	Low	Very low
Finishing	Very Rough	Rough	Rough	Very Rough	Rough	Clean	More clean
Rust resistant	Regular	Regular	Good	Very good	Very good	Very good	Very good
Work material	Stainless	×	×	◎	◎	×	×
	Metal	◎	◎	◎	◎	◎	◎
	Wood	×	×	○*	×	×	◎
	PVC	×	×	×	×	×	◎

◎ : Highly suitable ○ : Suitable × : Not use *Cannot be used for wood when you use with grinders.

Wire brush for angle grinder/ Cup/ Crimped



Range	Outer dia. mm(inch)	Thread mm(inch)	Brush Type	For Model	Sales Pkg Qty	Part No.
★★★★☆	60	M10x1.5	Steel wire 0.3mm	100mm Angle grinder	1	D-24066
	75				1	D-24088
	60	M14x2.0	Brass coated steel wire 0.3mm	115, 125, 150mm Angle grinder	1	D-39746
	75				1	D-39768
	60	M14x2.0	Steel wire 0.3mm	115, 125, 150mm Angle grinder	1	D-24072
	75				1	D-24094
	90	M14x2.0	Brass coated steel wire 0.3mm	180, 230mm Angle grinder	1	D-39780
	100				1	D-39805
	100	M14x2.0	Steel wire 0.3mm	180, 230mm Angle grinder	1	D-29284
	(2-1/2)				1	D-39752
	(3)	(5/8x11 UNC)	Brass coated steel wire 0.0118inch	115, 125, 150mm Angle grinder	1	D-39774
	(2-1/2)				1	D-26515
	(3)	(5/8x11 UNC)	Steel wire 0.0118inch	115, 125, 150mm Angle grinder	1	D-26521
	(3-1/2)				1	D-39796
	(4)	(5/8x11 UNC)	Brass coated steel wire 0.0118inch	180, 230mm Angle grinder	1	D-39811
	(4)				1	D-31697

Wire brush for angle grinder/ Cup/ Knotted



Steel Wire

Range	Outer dia. mm(inch)	Thread mm(inch)	Brush Type	For Model	Sales Pkg Qty	Part No.
★★★★☆	60	M10x1.5	Steel wire 0.5mm	100mm Angle grinder	1	D-24103
	75				1	D-24125
	60	M14x2.0	Steel wire 0.5mm	115, 125, 150mm Angle grinder	1	D-24119
	75				1	D-24131
	(2-1/2)	(5/8x11 UNC)	Steel wire 0.02 inch	115, 125, 150mm Angle grinder	1	D-26537
	(3)				1	D-26543
	(4)				1	D-31706
	(4)				1	D-31706

Wire brush for angle grinder/ Cup with metal cover/ Knotted



Steel Wire

Range	Outer dia. mm(inch)	Thread mm(inch)	Brush Type	For Model	Sales Pkg Qty	Part No.
★★★★☆	60	M10x1.5	Steel wire 0.5mm	100mm Angle grinder	1	D-24147
		M14x2.0		115, 125, 150mm Angle grinder	1	D-24153
	100		(5/8x11 UNC)	Steel wire 0.02 inch	180, 230mm Angle grinder	1
	(2-1/2)	115, 125, 150mm Angle grinder			1	D-26559
	(4)	(5/8x11 UNC)	Steel wire 0.02 inch	180, 230mm Angle grinder	1	D-31712
	(4)				1	D-31712

Wire brush for angle grinder/ Wheel/ Knotted



Steel Wire

Range	Outer dia. mm(inch)	Thread mm(inch)	Brush Type	For Model	Sales Pkg Qty	Part No.	
★★★★☆	100	M14x2.0	Steel wire 0.5mm	180, 230mm Angle grinder	1	D-29555	
	115				1	D-29561	
	125				1	D-29577	
	150				1	D-45761	
	175	(5/8x11 UNC)	Steel wire 0.02 inch	230mm Angle grinder	1	D-45777	
	(6)				180, 230mm Angle grinder	1	D-45783
	(7)				230mm Angle grinder	1	D-45799
						1	D-45799

Wire brush for angle grinder/ Bevel/ Crimped



Steel Wire

Range	Outer dia. mm(inch)	Thread mm(inch)	Brush Type	For Model	Sales Pkg Qty	Part No.
★★★★☆	100	M14x2.0	Steel wire 0.3mm	115, 125, 150mm Angle grinder	1	D-39827
	115				1	D-39849
	(4)	(5/8x11 UNC)	Steel wire 0.0118 inch	115, 125, 150mm Angle grinder	1	D-39833
	(4-1/2)				1	D-39855

Wire brush for angle grinder/ Bevel/ Knotted



Range	Outer dia. mm(inch)	Thread mm(inch)	Brush Type	For Model	Sales Pkg Qty	Part No.
★★★★☆	100	M14x2.0	Steel wire 0.5mm	115, 125, 150mm Angle grinder	1	D-39861
	115		1		D-39883	
	(4)	(5/8x11 UNC)	Steel wire 0.02inch		1	D-39877
	(4-1/2)	1	D-39899			

Wire brush for angle grinder with X-lock/ Cup/ Crimped



Range	Outer dia. mm	Thread	Brush Type	For Model	Sales Pkg Qty	Part No.
★★★★☆	75	X-LOCK	Brass coated steel wire 0.3mm	100, 115, 125mm Angle grinder (X-LOCK)	1	D-73433
			Stainless steel wire 0.3	1	D-73346	
			Steel wire 0.3mm	1	D-73396	

Wire brush for angle grinder with X-lock/ Cup/ Knotted



Range	Outer dia. mm	Thread	Brush Type	For Model	Sales Pkg Qty	Part No.
★★★★☆	80	X-LOCK	Stainless steel wire 0.5mm	100, 115, 125mm Angle grinder (X-LOCK)	1	D-73330
			Steel wire 0.35mm		1	D-73374
			Steel wire 0.5mm		1	D-73380

Wire brush for angle grinder with X-lock/ Wheel/ Crimped



Range	Outer dia. mm	Thread	Brush Type	For Model	Sales Pkg Qty	Part No.
★★★★☆	115	X-LOCK	Steel wire 0.3mm	115, 125mm Angle grinder (X-LOCK)	1	D-73427

Wire brush for angle grinder with X-lock/ Wheel/ Knotted



Range	Outer dia. mm	Thread	Brush Type	For Model	Sales Pkg Qty	Part No.
★★★★☆	115	X-LOCK	Stainless steel wire 0.5mm (Full Knotted)	115, 125mm Angle grinder (X-LOCK)	1	D-73352
			Stainless steel wire 0.5mm (Stringer Knotted)		1	D-73368
			Steel wire 0.5mm (Full Knotted)		1	D-73405
			Steel wire 0.5mm (Stringer Knotted)		1	D-73411

Wire brush for angle grinder with X-lock/ Bevel/ Crimped



Range	Outer dia. mm	Thread	Brush Type	For Model	Sales Pkg Qty	Part No.
★★★★☆	100	X-LOCK	Steel wire 0.3mm	100, 115, 125mm Angle grinder (X-LOCK)	1	D-73449

Wire brush for drill/ Cup/ Crimped



Range	Outer dia. mm	Shaft mm(inch)	Brush Type	Sales Pkg Qty	Part No.	
★★★★☆	38	6	Steel wire 0.3mm	1	D-39908	
	50			1	D-39914	
	63			1	D-39920	
	75			1	D-39936	
	80			1	D-39942	
	38			(1/4 Hex MZ)	Brass coated steel wire 0.3mm	1
	50	1	D-73617			
	63	1	D-73623			
	75	1	D-73639			
	80	1	D-73645			
	38	Stainless wire 0.3mm	1			D-76554
	50		1		D-76560	
	65		1		D-76576	
	75		1		D-76582	
	80		1		D-76598	
	38		(1/4 Hex NZ)		Steel wire 0.3mm	1
	50	1				D-76423
	65	1		D-76439		
	75	1		D-76445		
	80	1		D-76451		
	38	Brass coated steel wire 0.3mm		1	D-76308	
	50			1	D-76314	
	75			1	D-76320	

Wire brush for drill/ Cup/ Knotted



Range	Outer dia. mm	Shaft mm(inch)	Brush Type	Sales Pkg Qty	Part No.
★★★★★	63	6	Steel wire 0.5mm	1	D-73798
	75			1	D-73807
	65	(1/4 Hex MZ)	Stainless wire 0.5mm	1	D-76691
	75			1	D-76700

Wire brush for drill/ Wheel/ Crimped



Range	Outer dia. mm	Shaft mm(inch)	Brush Type	Sales Pkg Qty	Part No.
★★★★★	38	6	Steel wire 0.3mm	1	D-39958
	50			1	D-39964
	63			1	D-39970
	75			1	D-39986
	100			1	D-39992
★★★★★	80	8	Brass coated steel wire 0.25mm	1	D-67608
	38	(1/4 Hex MZ)	Brass coated steel wire 0.3mm	1	D-73651
	50			1	D-73667
	63			1	D-73673
	75			1	D-73689
	100			1	D-73695
	38		Stainless wire 0.3mm	1	D-76607
	50			1	D-76613
	65			1	D-76629
	75			1	D-76635
	100			1	D-76641
	38	(1/4 Hex NZ)	Steel wire 0.3mm	1	D-76467
	50			1	D-76473
	65			1	D-76489
	75			1	D-76495
	100			1	D-76504
	38		Brass coated steel wire 0.3mm	1	D-76336
	50			1	D-76342
	75			1	D-76358
	100			1	D-76364

Wire brush for drill/ Wheel/ Knotted



Range	Outer dia. mm	Shaft mm(inch)	Brush Type	Sales Pkg Qty	Part No.
★★★★★	75	6	Steel wire 0.5mm	1	D-73813
	100			1	D-73829
	75	(1/4 Hex MZ)	Stainless wire 0.5mm	1	D-76716
	100			1	D-76722

Wire brush for drill/ End/ Crimped



Range	Outer dia. mm	Shaft mm(inch)	Brush Type	Sales Pkg Qty	Part No.
★★★★★	12	6	Steel wire 0.3mm	1	D-40004
	19			1	D-40010
	25			1	D-40026
	30			1	D-40032
	12	(1/4 Hex MZ)	Brass coated steel wire 0.3mm	1	D-73704
	19			1	D-73710
	24			1	D-73726
	28			1	D-73732
	12		Stainless wire 0.3mm	1	D-76657
	19			1	D-76663
	24			1	D-76679
	28			1	D-76685
	12	(1/4 Hex NZ)	Steel wire 0.3mm	1	D-76510
	19			1	D-76526
	24			1	D-76532
	28			1	D-76548
	12		Brass coated steel wire 0.3mm	1	D-76370
	19			1	D-76386
	24			1	D-76392
	28			1	D-76401

Wire brush for drill/ End/ Knotted



Range	Outer dia. mm	Shaft mm(inch)	Brush Type	Sales Pkg Qty	Part No.
★★★★★	12	6	Steel wire 0.5mm	1	D-73835
	19			1	D-73841
	24			1	D-73857
	28			1	D-73863
	12	(1/4 Hex MZ)	Stainless wire 0.5mm	1	D-76738
	19			1	D-76744
	24			1	D-76750
	28			1	D-76766

Wire brush for drill assortment



Range	Note	Shaft mm	Brush Type	Sales Pkg Qty	Part No.
★★★★★	Cup-Crimped: 50mm, End-Crimped: 25mm, Wheel-Crimped: 50mm	6	Steel wire 0.3mm	3	D-66070
	Cup-Crimped: 63,75mm, Wheel-Crimped: 75,100mm			4	D-65729

Nylon brush for drill/ Cup



Range	Outer dia. mm	Shaft mm	Brush Type	Sales Pkg Qty	Part No.
★★☆☆☆	50	6	Coarse	1	D-45509
	63			1	D-45515
	75			1	D-45521
	50		Fine	1	D-45537
	63			1	D-45543
	75			1	D-45559

Nylon brush for drill/ Flap

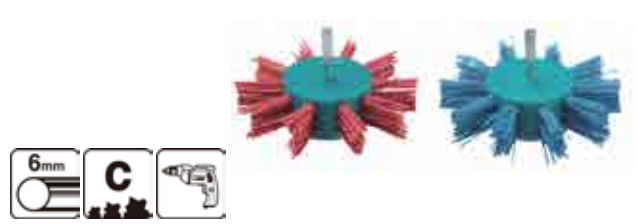

Range	Outer dia. mm	Shaft mm	Brush Type	Sales Pkg Qty	Part No.
★★☆☆☆	100	6	Coarse	1	D-45749
			Fine	1	D-45755

Nylon brush for drill/ Wheel



Range	Outer dia. mm	Shaft mm	Brush Type	Sales Pkg Qty	Part No.
★★☆☆☆	38	6	Coarse	1	D-45565
	50			1	D-45571
	63			1	D-45587
	75			1	D-45593
	100			1	D-45602
	38		Fine	1	D-45618
	50			1	D-45624
	63			1	D-45630
	75			1	D-45646
	100			1	D-45652

Nylon brush for drill assortment



Range	Note	Shaft mm	Brush Type	Sales Pkg Qty	Part No.
★★☆☆☆	Cup: 50mm, Wheel: 50mm, End: 24mm	6	Coarse	3	D-70742
	Cup: 50mm, Wheel: 50mm, End: 24mm		Fine	3	D-70758

Wire brush for wheel sander



Range	Outer dia. mm	Brush Type	Sales Pkg Qty	Part No.
★★☆☆☆	100	Brass coated steel wire 0.3mm	1	D-73570
		Steel wire 0.3mm	1	D-73564

Nylon brush for drill/ End



Range	Outer dia. mm	Shaft mm	Brush Type	Sales Pkg Qty	Part No.
★★☆☆☆	12	6	Coarse	1	D-45668
	17			1	D-45674
	24			1	D-45680
	30			1	D-45696
	12		Fine	1	D-45705
	17			1	D-45711
	24			1	D-45727
	30			1	D-45733

Nylon brush for wheel sander



Range	Outer dia. mm	Brush Type	Grit	Sales Pkg Qty	Part No.
★★☆☆☆	100	Coarse	C60	1	D-73586
	100	Medium	C80	1	D-73592

Sponge type

Flat

Feature: Full contact surface
Use: Suitable for large, flat, panel



Wave

Feature: Air flow between the pad and the paint.
Use: Suitable for bumper made with resin.



Sponge pad/ High repulsion

Color & Application

Coarse

Color: Orange
Use: Suitable for making wool bonnet sanding trace invisible



Medium

Color: Blue
Use: Suitable for finishing



Fine

Color: Black
Use: Suitable for Mirror finishing applying wax, making polishing traces invisible



Range	Outer dia. mm	Note	Type	Brush Type	Sales Pkg Qty	Part No.
★★★★☆	100	Hook & Loop type	Flat	Coarse	1	D-62505
				Medium	1	D-62533
				Fine	1	D-62561
			Wave	Coarse	1	D-62599
				Medium	1	D-62620
				Fine	1	D-62658
	125		Flat	Coarse	1	D-62511
				Medium	1	D-62549
				Fine	1	D-62577
			Wave	Coarse	1	D-62608
				Medium	1	D-62636
				Fine	1	D-62664
150	Flat	Coarse	1	D-62527		
		Medium	1	D-62555		
		Fine	1	D-62583		
	Wave	Coarse	1	D-62614		
		Medium	1	D-62642		
		Fine	1	D-62670		
190	Flat	Coarse	1	D-74572		
		Medium	1	D-74588		
		Fine	1	D-70801		

Wool pad/ Double side adapter



Range	Note	Sales Pkg Qty	Part No.
★★★★☆	M14 Adapter for Wool pad Double side	1	D-56960
	M16 Adapter for Wool pad Double side	1	D-57043

Sponge pad/ Low repulsion

Color & Application

Coarse

Color: Yellow
Use: Suitable for making paper sanding traces invisible

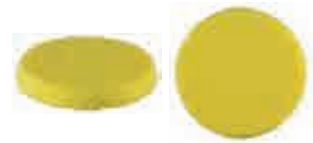

Medium

Color: White
Use: Suitable for finishing



Range	Outer dia. mm	Note	Type	Brush Type	Sales Pkg Qty	Part No.
★★★★☆	120	Hook & Loop type	Flat	Coarse	1	D-74647
				Medium	1	D-75960
	150			Coarse	1	D-74653
				Medium	1	D-75976
	170			Coarse	1	D-74669
				Medium	1	D-75982
	190			Coarse	1	D-70786
				Medium	1	D-70792

Wool pad



Range	Outer dia. mm	Note	Sales Pkg Qty	Part No.
★★★★☆	100	Hook & Loop type	1	D-67000
	125		1	D-70867
	150		1	D-65735
	180		1	D-74594

Wool pad/ Double side



Range	Outer dia. mm	Note	Brush Type	Sales Pkg Qty	Part No.
★★★★☆	230	Use with M14/ M16 adapter	Coarse	1	D-70873
	230	Use with M14/ M16 adapter	Fine	1	D-70889

Felt pad



Range	Outer dia. mm	Note	Sales Pkg Qty	Part No.
★★★★☆	100	Hook & Loop type	1	D-74603
	125		1	D-74631
	150		1	D-74619
	190		1	D-74625

ACCESSORIES

▣ Bonded Abrasive



Flexible



Always use
back up pad



Fast cut



3mm
3mm cylindrical
shank



6mm
6mm cylindrical
shank

New Label design



Lot number and validity : on washer (If there is not on washer, there is on label)

Point 1 The icon tell that how to use.

	for metal	for INOX	for Masonry	for Aluminum
Grinding				
Cutting for grinder				
Cutting for portable cut-off			—	
Cutting for power cutter		—		—

Point 2 The marks tell the range in makita.



performance more good

Point 3 How to read the spec.

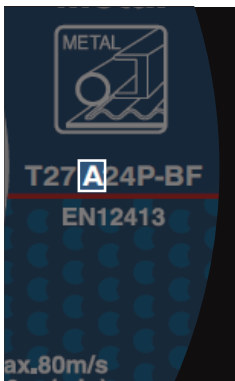

Aluminum Oxide Group (mainly for metal & INOX)

Brown Fused Aluminum: A

The most common abrasive material for metal.



Single Aluminum Oxide: SA

Single crystal abrasive material with high tenacity. Higher durability and grinding/cutting performance than A.



White Aluminum Oxide: WA

High purity abrasive material, eliminated extraneous elements from A. Higher grinding and cutting performance than A.



Alumina Zirconium: Z

Extremely sharp and hard abrasive material. Grinding/cutting performance than SA.



Ceramic:



Extremely sharp and high resistant to shock/heat/wear. High grade abrasive material with excellent grinding performance and durability.

Silicon Oxide Group (mainly for non-metallic)

Black Silicon Carbide: C

The most common abrasive material for non-metal.



Green Silicon Carbide: GC

Higher purity than C, eliminated extraneous elements, thus having higher grinding and cutting performance than C, but a little lower durability than C.



Bonded Abrasive

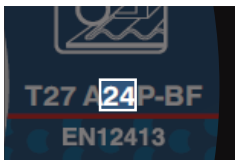

Grit Size

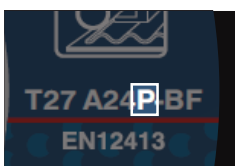
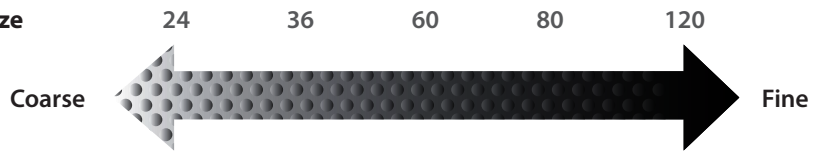

Hardness of grinding wheel

Closer to A, softer grinding wheel is
Closer to Z, harder grinding wheel is

Soft grinding wheel ▶ Hard work piece
Hard grinding wheel ▶ Soft work piece

Very Soft	Soft	Middle	Hard	Very Hard
A - G	H - K	L - O	P - S	T - Z

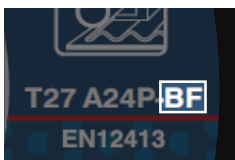

Type of Bond

BF : Reinforced resinoid bond
V : Vitrified bond

Point 4 The color tell the application.

	for metal	for INOX	for Masonry	for Aluminum
color	 Blue	 Orange	 Green	 Gray

Grinding wheel/ Metal/ Depressed



Range	Material	Outer dia. mm (inch)	Thickness mm (inch)	Inner dia. mm (inch)	Grit	Sales Pkg Qty	Part No.
★★★★☆	Metal	100 (4)	4.0 (5/32)	16.00 (5/8)	A36P	1	A-80905
					A36P	1	B-07272
					A24P	1	A-85391
					A24R	1	A-87719
					A24R	1	A-80911
					A24R	1	B-07266
		A24R	1	B-46246			
		A36P	1	A-80927			
		A36P	1	B-46252			
		A36P	1	A-80933			
		A36P	1	B-46268			
		A24R	1	A-84981			
		A24R	1	A-88886			
		A36P	1	A-80949			
		A36P	1	B-46274			
A36P	1	A-80955					
A36P	1	B-46280					
★★★☆☆	Metal	100 (4)	6.0 (1/4)	16.00 (5/8)	A24P	1	D-65090
					A24P	1	D-18459
		A24R			10	D-18459-10	
		A24R			20	D-18459-20	
		A24P			1	D-65919	
		A24P			1	D-18465	
		A24R			10	D-18465-10	
		A24R			20	D-18465-20	
★★★☆☆	Metal	125 (5)	6.0 (1/4)	22.23 (7/8)	A24P	1	D-65925
					A24P	1	D-26163
		A24R			1	D-18471	
		A24R			1	D-18487	
		A24R			1	D-18487	
		A24R			1	D-18487	
★★★★☆	Metal	100 (4)	6.0 (1/4)	22.23 (7/8)	A24P	1	D-72883
					A24P	1	D-72241
		A24P			1	D-74485	
		A24P			1	D-74491	
		A24P			1	D-74500	
		A24P			1	D-74516	
A24P	1	D-74522					

Grinding wheel/ Stainless / Depressed



Range	Material	Outer dia. mm (inch)	Thickness mm (inch)	Inner dia. mm (inch)	Grit	Sales Pkg Qty	Part No.	
★★★★☆	Stainless, Metal	100 (4)	6.0 (1/4)	16.00 (5/8)	A24R	1	B-21107	
					WA36N	1	A-80852	
					WA36N	1	B-46349	
					A24R	1	B-21113	
					WA36N	1	A-80640	
					A24R	1	B-21129	
		115 (4-1/2)	6.0 (1/4)	22.23 (7/8)	22.23 (7/8)	A24R	1	A-80656
						WA36N	1	B-46361
						WA36N	1	A-80846
						A24R	1	B-21135
						WA36O	1	A-80880
						A24R	1	B-21141
		125 (5)	6.0 (1/4)	22.23 (7/8)	22.23 (7/8)	A24R	1	A-80896
						WA36O	1	B-46383
						WA36O	1	B-46383

Grinding wheel/ Stainless/ Depressed/ for heavy Industries



- 1. 7.2mm thickness for Heavy Industries. It is suitable to use with a high power grinder.

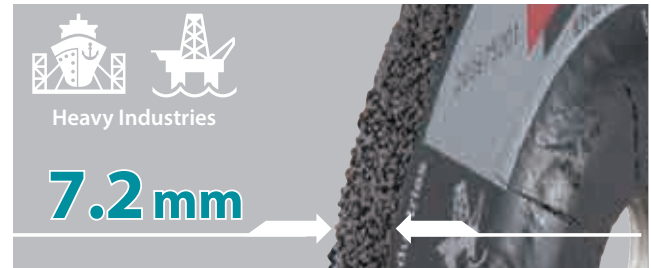

Grinding wheel/ Metal/ Depressed with X-LOCK



Range	Material	Outer dia. mm (inch)	Thickness mm (inch)	Thread	Grit	Sales Pkg Qty	Part No.
★★★★☆	Metal	100 (4)	6.0 (1/4)	X-LOCK	A36P	1	E-00480
		115 (4-1/2)				1	E-00365
		125 (5)				1	E-00393

- 2. Longer Life

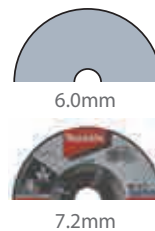

Grinding life time (min)

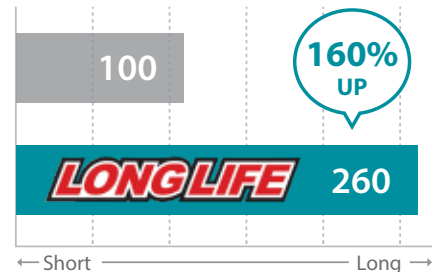

Range	Material	Outer dia. mm (inch)	Thickness mm (inch)	Inner dia. mm (inch)	Grit	Sales Pkg Qty	Part No.
★★★★★	Stainless, Metal	115 (4-1/2)	7.0 (9/32)	22.23 (7/8)	A24P (CERAMIC)	1	B-66911
		125 (5)			A24S	1	B-66927
★★★★☆	Stainless, Metal	115 (4-1/2)	7.2 (9/32)	22.23 (7/8)	A24S	1	B-56362
					AZ24N	1	B-56378
		125 (5)			A24S	1	B-56384
					AZ24N	1	B-56390
180 (7)	A24S	1	B-56409				
	AZ24N	1	B-56415				

Grinding wheel/ Stainless/ Depressed with X-LOCK



Range	Material	Outer dia. mm (inch)	Thickness mm (inch)	Thread	Grit	Sales Pkg Qty	Part No.
★★★☆☆	Stainless, Metal	100 (4)	6.0 (1/4)	X-LOCK	WA36N	1	E-00496
		115 (4-1/2)				1	E-00371
		125 (5)				1	E-00402

Grinding wheel/ Aluminum/ Depressed



Range	Material	Outer dia. mm (inch)	Thickness mm (inch)	Inner dia. mm (inch)	Grit	Sales Pkg Qty	Part No.
★★★☆☆	Aluminium	100 (4)	6.0 (1/4)	16.00 (5/8)	A36N	1	B-17706
		115 (4-1/2)		1		B-14560	
		125 (5)		1		B-17653	
		150 (6)		1		B-17669	
		180 (7)		1		B-14576	
		230 (9)		1		B-14582	
		22.23 (7/8)					

Grinding wheel/ Masonry/ Depressed



Range	Material	Outer dia. mm (inch)	Thickness mm (inch)	Inner dia. mm (inch)	Grit	Sales Pkg Qty	Part No.
★★☆☆☆	Masonry	100 (4)	6.0 (1/4)	16.00 (5/8)	C24R	1	D-18493
		115 (4-1/2)		1		D-18502	
		125 (5)		1		D-18518	
		150 (6)		1		D-18524	
		180 (7)		1		D-18530	
		230 (9)		1		D-18546	

Flexible grinding wheel

1. Less noise
2. Low vibration
3. As flexible grinding wheel cause almost no tapping, it provides excellent workability
4. Wide range of Applications

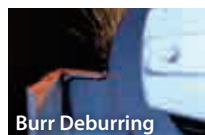
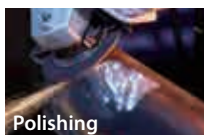
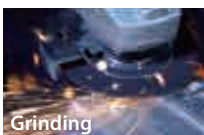

Flexible grinding wheel/ Metal/ Depressed



Range	Material	Outer dia. mm (inch)	Thickness mm (inch)	Inner dia. mm (inch)	Grit	Sales Pkg Qty	Part No.
★★★☆☆	Metal	100 (4)	2.0 (5/64)	16.00 (5/8)	AC46P	1	B-18203
					AC60P	1	A-85139
					AC80P	1	B-18219
			AC120P		1	B-18225	
			AC36P		1	B-18231	
			AC46P		1	B-18247	
		AC60P	1	B-18253			
		AC80P	1	B-18269			
		115 (4-1/2)	3.0 (1/8)	AC36P	1	B-18275	
				AC46P	1	B-18281	
				AC60P	1	B-18297	
			AC80P	1	B-18306		
			125 (5)	3.0 (1/8)	AC36P	1	B-18312
					AC46P	1	B-18328
		AC60P			1	B-18334	
		180 (7)	3.0 (1/8)	AC80P	1	B-18340	
				AC36P	1	B-18356	
				AC46P	1	B-18362	
			230 (9)	3.0 (1/8)	AC60P	1	A-88490
					AC80P	1	B-18378
					AC36P	1	B-18384
		22.23 (7/8)	3.0 (1/8)	AC46P	1	B-18390	
				AC60P	1	B-18409	
				AC80P	1	B-18415	

Flexible grinding wheel/ Stainless/ Depressed



Range	Material	Outer dia. mm (inch)	Thickness mm (inch)	Inner dia. mm (inch)	Grit	Sales Pkg Qty	Part No.
★★★☆☆	Stainless, Metal	100 (4)	2.0 (5/64)	16.00 (5/8)	WA46P	1	B-18421
					WA60P	1	B-18437
					WA80P	1	B-18443
			WA120P		1	B-18459	
			WA36P		1	B-18465	
			WA46P		1	B-18471	
		WA60P	1	B-18487			
		WA80P	1	B-18493			
		115 (4-1/2)	3.0 (1/8)	WA36P	1	B-18502	
				WA46P	1	B-18518	
				WA60P	1	B-18524	
			WA80P	1	B-18530		
			125 (5)	3.0 (1/8)	WA36P	1	B-18546
					WA46P	1	B-18552
		WA60P			1	B-18568	
		180 (7)	3.0 (1/8)	WA80P	1	B-18574	
				WA36P	1	B-18580	
				WA46P	1	B-18596	
			230 (9)	3.0 (1/8)	WA60P	1	B-18605
					WA80P	1	B-18611
					WA36P	1	B-18627
		22.23 (7/8)	3.0 (1/8)	WA46P	1	B-18633	
				WA60P	1	B-18649	
				WA80P	1	B-18655	

Flexible grinding wheel/ Stainless/ Depressed/ Ideal for Cordless angle grinder



1. Amount of grinding per 1 charged 70%up than grinding wheel/ stainless.
2. Vibration 60% off than grinding wheel/ stainless.



Range	Material	Outer dia. mm (inch)	Thickness mm (inch)	Inner dia. mm (inch)	Grit	Sales Pkg Qty	Part No.
★★★★☆	Stainless, Metal	100 (4)	4.0 (5/32)	16.00 (5/8)	WA36P	1	B-52392
		115 (4-1/2)		22.23 (7/8)		1	B-49775
		125 (5)		22.23 (7/8)		1	B-53110

Flexible grinding wheel/ Masonry/ Depressed



1. GC grain



Contains GC (Green Silicon Carbide) grain which is specialized to grind stone/glass.

2. Ground surface



A rough ground surface releases dust smoothly and reduces clogging.

3. Flexible



Original manufacturing method realized high flexibility. Clean surface is available.

Application

1. Chamfering of marble



2. Grinding marble's curved surface



3. Deburring of glass



*Always use with back-up pad.

Range	Material	Outer dia. mm (inch)	Thickness mm (inch)	Inner dia. mm (inch)	Grit	Sales Pkg Qty	Part No.
★★★★☆	Masonry	100 (4)	2.0 (5/64)	16.00 (5/8)	GC46	1	B-18661
					GC60	1	B-18677
					GC80	1	B-18683
					GC120	1	B-18699
					GC36	1	B-18708
		115 (4-1/2)	3.0 (1/8)	22.23 (7/8)	GC60P	1	B-51356
					GC80P	1	B-51362
					GC120P	1	B-51378
					GC60P	1	E-02294
					GC80P	1	E-02303
					GC120P	1	E-02319

Back up pad for Flexible grinding wheel



Range	Note	Sales Pkg Qty	Part No.
★★★★☆	Back Up Pad for 100mm	1	B-20476
	Back Up Pad for 115/125mm	1	B-20482
	Back Up Pad for 180mm	1	B-20498
	Back Up Pad for 230mm	1	B-20507

Cut-off wheel/ Metal/ Flat



Range	Material	Outer dia. mm (inch)	Thickness mm (inch)	Inner dia. mm (inch)	Grit	Sales Pkg Qty	Part No.
★★★★☆	Metal	100 (4)	2.0 (5/64)	16.00 (5/8)	A46S	1	A-85123
						1	A-85298
						1	B-46399
						1	A-85307
						1	B-46408
		115 (4-1/2)	22.23 (7/8)	A30R	1	A-85313	
					1	B-46414	
					1	A-85329	
					1	B-46420	
					1	A-85335	
125 (5)	2.5 (3/32)	16.00 (5/8)	A30S	1	B-46436		
				1	D-18655		
				50	D-18655-50		
				1	D-18661		
				50	D-18661-50		
180 (7)	22.23 (7/8)	22.23 (7/8)	A30S	1	D-18677		
				50	D-18677-50		
				1	D-29402		
				1	D-18683		
				50	D-18683-50		
230 (9)				1	D-18699		
				25	D-18699-25		

Cut-off wheel/ Metal/ Depressed



Range	Material	Outer dia. mm (inch)	Thickness mm (inch)	Inner dia. mm (inch)	Grit	Sales Pkg Qty	Part No.
★★★★☆	Metal	100 (4)	3.0 (1/8)	16.00 (5/8)	A30T	1	A-83587
		115 (4-1/2)				1	A-83593
		125 (5)				1	B-21200
		150 (6)				1	A-83602
		180 (7)				1	B-05050
		230 (9)				1	A-83618
★★★★☆	Metal	100 (4)	3.0 (1/8)	22.23 (7/8)	A30T	1	A-83624
		115 (4-1/2)				1	B-62913
		125 (5)				1	D-18552
		150 (6)				1	D-18568
		180 (7)				1	D-18574
		230 (9)				1	D-29418
★★★★☆	Metal	100 (4)	3.0 (1/8)	16.00 (5/8)	A30R	1	D-18580
		115 (4-1/2)				1	D-18596
		125 (5)				1	
		150 (6)				1	
		180 (7)				1	
		230 (9)				1	

Thin cut-off wheel/ Metal/ Flat



Range	Material	Outer dia. mm (inch)	Thickness mm (inch)	Inner dia. mm (inch)	Grit	Sales Pkg Qty	Part No.
★★★★☆	Metal	115 (4-1/2)	1.6 (1/16)	22.23 (7/8)	A46U	1	B-14102
		10				B-14102-10	
		1				B-35134	
		10				B-35134-10	

Thin cut-off wheel/ Stainless metal/ Flat



Range	Material	Outer dia. mm (inch)	Thickness mm (inch)	Inner dia. mm (inch)	Grit	Sales Pkg Qty	Part No.
★★★★☆	Stainless, Metal	100 (4)	1.6 (1/16)	16.00 (5/8)	A36S	1	B-45749
		115 (4-1/2)				1	B-45755
		125 (5)	22.23 (7/8)	1		B-46931	
		180 (7)		1.8 (1/14)		1	B-60458
		230 (9)		2.0 (5/64)		1	B-60464

Cut-off wheel/ Masonry/ Flat



Range	Material	Outer dia. mm (inch)	Thickness mm (inch)	Inner dia. mm (inch)	Grit	Sales Pkg Qty	Part No.	
★★★★☆	Masonry	100 (4)	3.0 (1/8)	16.00 (5/8)	C30T	1	A-86739	
		115 (4-1/2)				1	A-85357	
		125 (5)				22.23 (7/8)	1	A-85363
		180 (7)				1	A-85379	
		230 (9)				1	A-85385	
★★★★☆	Masonry	100 (4)	3.0 (1/8)	16.00 (5/8)	C30S	50	D-18708-50	
		115 (4-1/2)				1	D-18714	
		125 (5)				22.23 (7/8)	1	D-18720
		180 (7)				1	D-18736	
		230 (9)				1	D-18742	

Thin cut-off wheel/ Stainless/ Flat



Range	Material	Outer dia. mm (inch)	Thickness mm (inch)	Inner dia. mm (inch)	Grit	Sales Pkg Qty	Part No.		
★★★★☆	Stainless, Metal	100 (4)	1.0 (3/64)	16.00 (5/8)	A60V	1	E-17108		
						12	E-17108-12		
		25		E-17108-25					
		1		E-17114					
		12		E-17114-12					
		25		E-17114-25					
★★★★☆	Stainless, Metal	115 (4-1/2)	22.23 (7/8)	16.00 (5/8)	A60U	1	E-17120		
						12	E-17120-12		
						25	E-17120-25		
		1				E-03028			
		12				E-03028-12			
		25				E-03028-25			
		125 (5)	1.6 (1/16)	22.23 (7/8)	A60U	1	E-03034		
						12	E-03034-12		
						25	E-03034-25		
						1	E-03040		
						12	E-03040-12		
						25	E-03040-25		
180 (7)	1.9 (5/64)	22.23 (7/8)	A60T	1	B-12251				
				1	B-12267				
				1	B-12273				
				150 (6)	1.6 (1/16)	22.23 (7/8)	A60U	1	E-13742
								1	E-13758
								1	E-13764

Cut-off wheel/ Masonry/ Depressed



Range	Material	Outer dia. mm (inch)	Thickness mm (inch)	Inner dia. mm (inch)	Grit	Sales Pkg Qty	Part No.	
★★★★☆	Masonry	100 (4)	3.0 (1/8)	16.00 (5/8)	C30T	1	A-86745	
		115 (4-1/2)				1	A-85254	
		125 (5)				22.23 (7/8)	1	A-85260
		180 (7)				1	A-85276	
		230 (9)				1	A-85282	
		★★★★☆				Masonry	100 (4)	3.0 (1/8)
115 (4-1/2)	1		D-18611					
125 (5)	22.23 (7/8)		1	D-18627				
180 (7)	1		D-18633					
230 (9)	1		D-18649					

Range	Material	Outer dia. mm (inch)	Thickness mm (inch)	Inner dia. mm (inch)	Grit	Sales Pkg Qty	Part No.
★★★★☆	Stainless, Metal	100 (4)	1.0 (3/64)	16.00 (5/8)	WA46R	1	D-65947
						1	D-74871
						10	D-65947-10
						12	D-65947-12
		115 (4-1/2)	22.23 (7/8)	1	10	D-65953	
						1	D-72001
						10	D-65953-10
						10	D-72001-10
		125 (5)	22.23 (7/8)	1	10	D-65969	
						1	D-65969
						10	D-65969-10
						12	D-65969-12
	180 (7)	22.23 (7/8)	1	10	D-65975		
					1	D-65975	
					10	D-65975-10	
					12	D-65975-12	
	Stainless, Metal	100 (4)	1.0 (3/64)	16.00 (5/8)	WA60T	1	D-18758
						100	D-18758-100
						1	D-18764
						10	D-18764-10
115 (4-1/2)		22.23 (7/8)	1	10	D-18764-10		
					50	D-18764-50	
					100	D-18764-100	
					1	D-18770	
125 (5)		22.23 (7/8)	1	10	D-18770-10		
					50	D-18770-50	
					100	D-18770-100	
					1	D-29424	
150 (6)	22.23 (7/8)	1	10	D-18786			
				1	D-18786		
				1	D-18792		
				1	D-18792		
Stainless, Metal	100 (4)	1.0 (3/64)	16.00 (5/8)	WA46R	1	D-75518	
					1	D-77148	
					1	D-75524	
					1	D-75530	
	115 (4-1/2)	22.23 (7/8)	1	10	D-77154		
					1	D-75546	
					1	D-77160	
					1	D-75552	
	125 (5)	22.23 (7/8)	1	10	D-77176		
					1	D-77176	
					1	D-75568	
					1	D-77182	
150 (6)	22.23 (7/8)	1	10	D-77182			
				1	D-77182		
				1	D-77182		
				1	D-77182		

Thin cut-off wheel/ Stainless/ Depressed



Range	Material	Outer dia. mm (inch)	Thickness mm (inch)	Inner dia. mm (inch)	Grit	Sales Pkg Qty	Part No.
★★★★☆	Stainless, Metal	115 (4-1/2)	1.2 (3/64)	22.23 (7/8)	A60T	1	B-64587
		125 (5)				1	B-64593
		180 (7)				1	B-64602
		230 (9)				1	B-64618
★★★★☆	Stainless, Metal	100 (4)	1.2 (3/64)	16.00 (5/8)	WA60T	1	D-18801
		115 (4-1/2)				1	D-18817
		125 (5)				1	D-18823
		180 (7)				1	D-18839
230 (9)	1	D-18845					

Thin cut-off wheel/ Aluminum/ Flat



Range	Material	Outer dia. mm (inch)	Thickness mm (inch)	Inner dia. mm (inch)	Grit	Sales Pkg Qty	Part No.
★★★★☆	Aluminum	100 (4)	1.0 (3/64)	16.00 (5/8)	A60T	1	B-45319
		115 (4-1/2)				1	B-50192
		125 (5)				1	B-45325
		150 (6)	1.6 (1/16)	22.23 (7/8)		1	B-45331
		180 (7)				1	B-45347
		1				B-45353	
		1				B-45369	
230 (9)	1.9 (5/64)	1	B-45369				

Thin cut-off wheel/ Stainless/ Flat with X-LOCK



Range	Material	Outer dia. mm (inch)	Thickness mm (inch)	Thread	Grit	Sales Pkg Qty	Part No.
★★★★☆	Stainless, Metal	100 (4)	1.2 (3/64)	X-LOCK	A60T	1	E-00505
		115 (4-1/2)				1	E-00387
		125 (5)				1	E-00418

Thin cut-off wheel/ Multi material/ Flat



Range	Material	Outer dia. mm (inch)	Thickness mm (inch)	Inner dia. mm (inch)	Grit	Sales Pkg Qty	Part No.
Specialized	Multi material	100 (4)	1.2 (3/64)	16.00 (5/8)	C46T	1	E-10702
		115 (4-1/2)		22.23 (7/8)		1	E-10718
		125 (5)		22.23 (7/8)		1	E-10724

Thin cut-off wheel/ Stainless/ Flat/ Ideal for Cordless power cutter



Range	Material	Outer dia. mm (inch)	Thickness mm (inch)	Inner dia. mm (inch)	Grit	Sales Pkg Qty	Part No.
★★★★☆	Stainless, Metal	230 (9)	2.0	22.23 (7/8)	WA36R	1	E-03006
						25	E-03006-25

Ultra thin cut-off wheel/ Stainless

1. Cutting speed 40% up than 1.0mm cutting.
2. Number of cut with 1 charge 20% up than 1.0mm cutting.
3. Less burr of materials



4. Less dust of materials



Ultra thin cut-off wheel/ Stainless/ Flat/ Ideal for Cordless angle grinder



Range	Material	Outer dia. mm (inch)	Thickness mm (inch)	Inner dia. mm (inch)	Grit	Sales Pkg Qty	Part No.
★★★★☆	Stainless, Metal	100 (4)	0.8 (1/32)	16.00 (5/8)	Z60T	1	B-45711
						12	B-45711-12
						1	B-45727
						12	B-45727-12
						1	B-45733
						12	B-45733-12
		115 (4-1/2)	22.23 (7/8)	Z60U	1	E-10855	
					12	E-10855-12	
					25	E-10855-25	
					1	E-10861	
					12	E-10861-12	
					25	E-10861-25	
125 (5)	22.23 (7/8)	Z60U	1	E-10877			
			12	E-10877-12			
			25	E-10877-25			

Ultra thin cut-off wheel/ Stainless/ Depressed/ Ideal for Cordless angle grinder



Range	Material	Outer dia. mm (inch)	Thickness mm (inch)	Inner dia. mm (inch)	Grit	Sales Pkg Qty	Part No.
★★★★☆	Stainless, Metal	115 (4-1/2)	0.8 (1/32)	22.23 (7/8)	Z60T	1	B-46947
		125 (5)				1	B-46953

Grinding wheel/ Metal/ Depressed/ 2in1



1. Grinding and cutting with one wheel.
2. Time and cost saving thanks to its efficient workability.
3. Recommendable from DIY to professional.

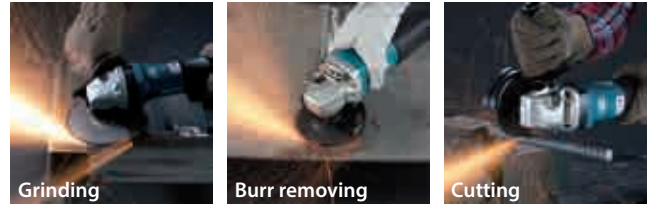

Range	Material	Outer dia. mm (inch)	Thickness mm (inch)	Inner dia. mm (inch)	Grit	Sales Pkg Qty	Part No.
★★★☆☆	Metal	100 (4)	3.2 (1/8)	16.00 (5/8)	A36T	1	B-21222
		115 (4-1/2)		22.23 (7/8)		1	B-21238
		125 (5)	4.0 (5/32)	1		B-21244	
		180 (7)		1		B-21250	

Grinding wheel/ Stainless/ Depressed/ 2in1/ Ideal for Cordless angle grinder



1. Cutting speed 10% up than 2in 1 wheel.
2. Number of cut with 1 charge 80% up than 2in 1 wheel.



Range	Material	Outer dia. mm (inch)	Thickness mm (inch)	Inner dia. mm (inch)	Grit	Sales Pkg Qty	Part No.
★★★★☆	Stainless, Metal	100 (4)	2.2 (5/64)	16.00 (5/8)	SA46P	1	B-51649
		115 (4-1/2)	2.0 (5/64)	22.23 (7/8)		1	B-50360
		125 (5)	2.2 (5/64)	1		B-51655	

Cut-off wheel for Portable cut-off/ Metal



Range	Material	Outer dia. mm (inch)	Thickness mm (inch)	Inner dia. mm (inch)	Grit	Sales Pkg Qty	Part No.	
★★★☆☆	Metal	305 (12)	3.0 (1/8)	25.40 (1)	A36P	25	A-05038	
						25	A-87650-25	
						25	A-88456-25	
						5	B-16891-5	
						5	B-16891-25	
					A30P	25	B-16891-25	
						5	B-20775-5	
						25	B-20775-25	
						A30Q	5	B-20753-5
							25	B-20753-25
		A30R	5	A-01351				
			5	A-87672-5				
			5	A-89545-5				
			5	A-89953-5				
			5	B-10665-5				
		A36P	5	B-10730-5				
			5	B-19881-5				
			25	A-05044				
			25	A-87585-25				
			25	A-87672-25				
25	A-89545-25							
25	A-89953-25							
25	B-10665-25							
25	B-10730-25							
25	B-19881-25							
405 (16)	3.0 (1/8)	25.40 (1)	A36P	25	B-55360-25			
				25	A-05050			
★★★☆☆	Metal	355 (14)	3.0 (1/8)	25.40 (1)	A36P	25	A-87694-25	
						25	A-88478-25	
						5	D-62088-5	
						25	D-71336-25	
						25	E-10540-25	

Cut-off wheel for Portable cut-off/ Stainless



- The optimum bonding
Heat-resistance property provides long life.

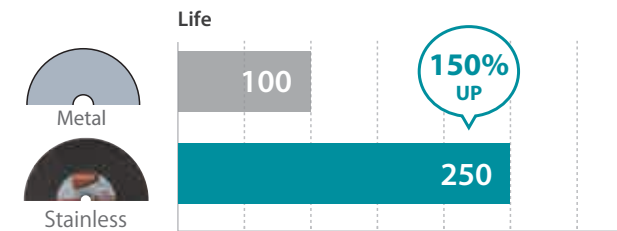

Range	Material	Outer dia. mm (inch)	Thickness mm (inch)	Inner dia. mm (inch)	Grit	Sales Pkg Qty	Part No.
★★★☆☆	Stainless, Metal	305 (12)	3.0 (1/8)	25.40 (1)	A30P	5	B-64571-5
						25	B-64571-25
		355 (14)	2.8 (7/64)	25.40 (1)	A30P	5	B-64565-5
						25	B-64565-25

Cut-off wheel for Portable cut-off/ Aluminum



- Minimize clogging
Minimize clogging which caused by the heat when you cut-off the material by adding special additive to the cut-off wheel.
Clog will occur when you cut aluminum with cut-off wheel which is not for aluminum

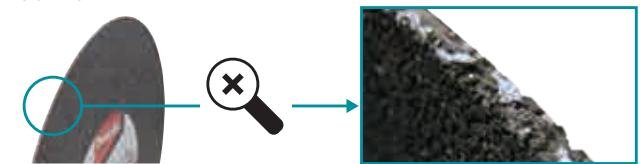

Range	Material	Outer dia. mm (inch)	Thickness mm (inch)	Inner dia. mm (inch)	Grit	Sales Pkg Qty	Part No.
Specialized	Aluminium	305 (12)	3.0 (1/8)	25.40 (1)	AC30P	5	E-04961-5
						25	E-04961-25

Cut-off wheel for Portable cut-off/ Metal/ Fast cut



Range	Material	Outer dia. mm (inch)	Thickness mm (inch)	Inner dia. mm (inch)	Grit	Sales Pkg Qty	Part No.
★★★☆☆	Metal	355 (14)	3.0 (1/8)	25.40 (1)	A30P	5	B-64353-5
						25	B-64353-25

Cut-off wheel for Portable cut-off/ Metal stud/ Ideal for Cordless Portable cut-off



Range	Material	Outer dia. mm (inch)	Thickness mm (inch)	Inner dia. mm (inch)	Grit	Sales Pkg Qty	Part No.
Specialized	Metal stud	355 (14)	2.5 (3/32)	25.40 (1)	A36P	5	B-64696-5
						25	B-64696-25

Cut-off wheel for Portable cut-off/ Aluminum/ Ideal for Cordless Portable cut-off



Range	Material	Outer dia. mm (inch)	Thickness mm (inch)	Inner dia. mm (inch)	Grit	Sales Pkg Qty	Part No.
Specialized	Aluminium	355 (14)	2.8 (7/64)	25.40 (1)	AC30P	5	E-04977-5
						25	E-04977-25

Thin cut-off wheel for Portable cut-off/ Metal



1. Thinner blade & the optimum bonding

2.5mm thickness blade for smooth and fast cutting.

The optimum bonding for fast cutting and longer life.

2.5 mm

2. Ideal for cordless tools

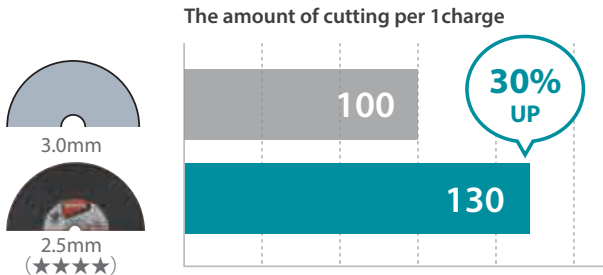

B-49448: For high voltage machine, B-57607: For low voltage machine

Range	Material	Outer dia. mm (inch)	Thickness mm (inch)	Inner dia. mm (inch)	Grit	Sales Pkg Qty	Part No.
★★★★☆	Metal	355 (14)	2.5 (3/32)	25.40 (1)	A36N	5	B-57607-5
						25	B-57607-25
					A36P	5	B-49448-5
						25	B-49448-25
					A30Q	5	B-20769-5
						25	B-20769-25
		2.4 (3/32)					

Cut-off wheel for Power cutter/ Metal/ Ideal for Cordless Power cutter



Range	Material	Outer dia. mm (inch)	Thickness mm (inch)	Inner dia. mm (inch)	Grit	Sales Pkg Qty	Part No.
★★★★☆	Metal	355 (14)	4.3 (11/64)	25.40 (1)	A24T	5	E-12790-5

Cut-off wheel for Power cutter/ Masonry/ Flat



Range	Material	Outer dia. mm (inch)	Thickness mm (inch)	Inner dia. mm (inch)	Grit	Sales Pkg Qty	Part No.
★★★★☆	Masonry	355 (14)	4.3 (11/64)	25.40 (1)	C24T	5	E-16966-5

Grinding wheel for Straight grinder



Range	Material	Outer dia. mm (inch)	Thickness mm (inch)	Inner dia. mm (inch)	Grit	Sales Pkg Qty	Part No.
★★★★☆	Metal	125 (5)	20.0 (13/16)	20.00	A24P	1	B-28662
				(13/16)	A36P	1	B-28678
		150 (6)		12.70	A24P	1	B-34017
				(13/16)	A36P	1	B-34023
				20.00	A24P	1	B-28684
				(13/16)	A36P	1	B-28690

Grinding wheel for Bench grinder



Range	Material	Outer dia. mm (inch)	Thickness mm (inch)	Inner dia. mm (inch)	Grit	Sales Pkg Qty	Part No.
★★★★☆	Metal	150 (6)	6.4 (1/4)	12.70 (1/2)	A60M	1	B-51895
			16.0 (5/8)	A36M	1	B-51904	
		205 (8)	19.0 (3/4)	15.88 (5/8)	A60M	1	B-51910
					A36P	1	B-51948
	Non-Ferrous Stainless Metal	150 (6)	16.0 (5/8)	12.70 (1/2)	GC120H	1	B-51932
		205 (8)	19.0 (3/4)	15.88 (5/8)	GC120H	1	B-51976
		150 (6)	16.0 (5/8)	12.70 (1/2)	WA60K	1	B-51926
					WA60K	1	B-51960
		205 (8)	19.0 (3/4)	15.88 (5/8)	WA60K	1	B-51960

Dressing stone



Range	Material	Grit	Note	Sales Pkg Qty	Part No.
★★★★☆	Metal	A1200	100x25mm	1	794063-3
			150x70mm	1	794061-7
			180x70mm	1	794060-9
			GC600	1	A-24642

Tungsten carbide burrs

Cut and application

Standard cut

<Feature> High efficiency
<Surface> Smooth
<Material> Metal, Stainless



Diamond cut

<Feature> Less vibration
<Surface> Rough
<Material> Metal, Stainless

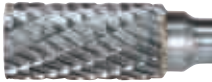

Non-ferrous cut

<Feature> Less clogging up
<Surface> Rough
<Material> Non-ferrous, Plastic



Shape and application

Shape : SA



Shape : SC



Shape : SF



Shape : SL



Shape : SM



Clean the burrs on inox



Deburr of aluminium

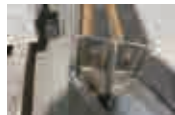

Wipe the welding line between steel plate



Wheel point



Range	Shank mm	Shape	Grit	Bit dia. mm	Working Length mm	Sales Pkg Qty	Part No.
★★★★☆	3	Cylinder	A60P	5	13.0	10	794050-2
				6		10	794051-0
				8		10	794052-8
				10		10	794053-6
			WA60P	5		10	794054-4
				6		10	794055-2
		Sphere	A60P	5	5.0	10	794056-0
				6	10	794057-8	
				8	10	794058-6	
				10	10.0	10	794059-4

Tungsten carbide burrs/ mm type



Range	Shank mm	Shape	Grit	Bit dia. mm	Working Length mm	Sales Pkg Qty	Part No.
★★★★☆	6	SA	Diamond cut	10	20	1	B-52722
		SC			20	1	B-52750
		SF			20	1	B-52788
		SL			25	1	B-52819
		SM			20	1	B-52847
		SA	Standard cut		20	1	B-52716
		SC			20	1	B-52744
		SF			20	1	B-52772
		SL			25	1	B-52803
		SM			20	1	B-52831
		SA	Non-ferrous cut		20	1	B-52738
		SC			20	1	B-52766
		SF			20	1	B-52794
		SL			25	1	B-52825
		SM			20	1	B-52853

ACCESSORIES

▣ Coated Abrasive



Thread for
Cordless sander
polisher



No wet use by
powertool



Hand sanding



Hand sanding
(wet)



Long life



12100rpm



6mm
6mm cylindrical
shank

New Label design



Point 1 The icon tell that how to use.

	for metal	for INOX	for Masonry
Grinding			

Point 2 The marks tell the range in makita.



Point 3 Grain and Grit

Aluminum Oxide Group (mainly for metal & INOX)

Grain

Brown Fused Aluminum: A
The most common abrasive material for metal.



Alumina Zirconium: Z
Extremely sharp and hard abrasive material. Grinding/cutting performance than SA.



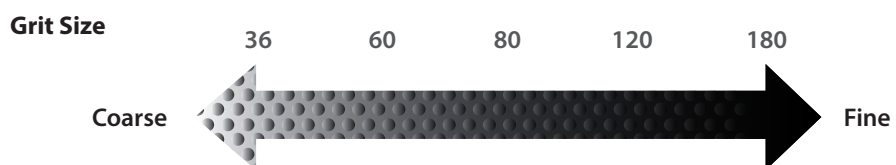
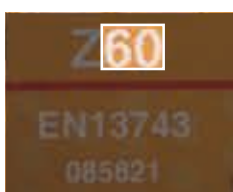
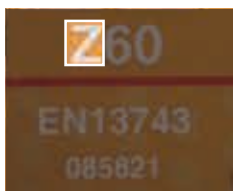

Silicon Oxide Group (mainly for non-metallic)

Black Silicon Carbide: C
The most common abrasive material for non-metal.



Point 4 The color tell the application.

	for metal	for INOX	for Masonry
color	 Blue	 Orange	 Green

Backing Type



Fiber glass backing
Standard backing type



Nylon backing
For heavy duty

Shape Type













Flat
Effective for flat surface



Angled
Effective for angles or corners

Material chart

AA : Recommended A : Acceptable

Description of Grit material		 Aluminum oxide	 Zirconia alumina	 Silicon carbide
Description of label color		Best for metal 	Best for INOX and metal 	Best for Masonry 
Plastic		A		
Metal		AA	AA	
No ferrous		A	A	
INOX			A	
Masonry				AA

*After reading instruction manual of grinder, please chose work material.

Flap disc aluminum oxide/ Fiberglass backing/ Angled



Range	Material	Outer dia. mm	Inner dia. mm	Grit	Sales Pkg Qty	Part No.
★★★★★	Metal, Non-ferrous, PVC	100	16.00	A40	1	D-63395
					10	D-63395-10
				A60	1	D-63404
					10	D-63404-10
			A80	1	D-63410	
				10	D-63410-10	
			A120	1	D-63426	
				10	D-63426-10	
		115	22.23	A40	1	D-63432
					10	D-63432-10
				A60	1	D-63448
					10	D-63448-10
			A80	1	D-63454	
				10	D-63454-10	
			A120	1	D-63460	
				10	D-63460-10	
125	22.23	A40	1	D-63476		
			10	D-63476-10		
		A60	1	D-63482		
			10	D-63482-10		
	A80	1	D-63498			
		10	D-63498-10			
	A120	1	D-63507			
		10	D-63507-10			
180	22.23	A40	1	D-63513		
			10	D-63513-10		
		A60	1	D-63529		
			10	D-63529-10		
	A80	1	D-63535			
		10	D-63535-10			
	A120	1	D-63541			
		10	D-63541-10			
★★★★★	Metal, Non-ferrous, PVC	100	16.00	A36	1	D-26973
					1	D-26989
				A60	1	D-26995
					1	D-27006
			A120	1	D-27012	
		115	22.23	A36	1	D-27028
					1	D-27034
				A60	1	D-27040
					1	D-27056
			A120	1	D-27062	
		125	22.23	A36	1	D-27078
					1	D-27084
				A60	1	D-27090
					1	D-27109
			A120	1	D-27115	
		180	22.23	A36	1	D-27121
	1			D-27137		
A60	1			D-27143		
	1			D-27159		
	A120	1	D-27165			

Flap disc zirconia aluminum/ Fiberglass backing/ Angled/ For heavy Industries



- High efficiency
 - Long life
 - Suitable for Industry use
- High-speed Grinding with high-power grinder.

Efficiency

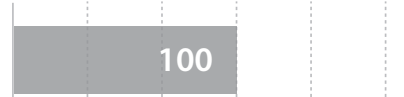

Life



Range	Material	Outer dia. mm	Inner dia. mm	Grit	Sales Pkg Qty	Part No.	
★★★★★	Stainless, Metal, Non-ferrous	115	22.23	Z40	1	B-55603	
					Z60	1	B-55619
					Z80	1	B-55625
					Z120	1	B-55631
			Z40	1	B-53920		
		125	22.23	Z60	1	B-53936	
					Z80	1	B-53942
					Z120	1	B-53958
				Z40	1	B-55647	
		180	22.23	Z60	1	B-55653	
					Z80	1	B-55669
					Z120	1	B-55675

Flap disc zirconia aluminum/ Fiberglass backing/ Angled



Range	Material	Outer dia. mm	Inner dia. mm	Grit	Sales Pkg Qty	Part No.	
★★★★★	Stainless, Metal, Non-ferrous	100	16.00	Z36	1	D-27377	
					Z40	1	D-27383
					Z60	1	D-27399
					Z80	1	D-27408
			Z120	1	D-27414		
		115	22.23	Z36	1	D-27420	
					Z40	1	D-27436
					Z60	1	D-27442
					Z80	1	D-27458
			Z120	1	D-27464		
		125	22.23	Z36	1	D-27470	
					Z40	1	D-27486
	Z60			1	D-27492		
	Z80			1	D-27501		
	Z120	1	D-27517				

Range	Material	Outer dia. mm	Inner dia. mm	Grit	Sales Pkg Qty	Part No.
★★★★☆	Stainless, Metal, Non-ferrous	180	22.23	Z36	1	D-27523
				Z40	1	D-27539
				Z60	1	D-27545
				Z80	1	D-27551
				Z120	1	D-27567
★★★★☆	Stainless, Metal, Non-ferrous	100	16.00	Z40	1	D-63703
				10	10	D-63703-10
				Z60	1	D-63719
				10	10	D-63719-10
				Z80	1	D-63725
				10	10	D-63725-10
		115	22.23	Z40	1	D-63731
				10	10	D-63731-10
				Z60	1	D-63747
				10	10	D-63747-10
				Z80	1	D-63753
				10	10	D-63753-10
		125	22.23	Z80	1	D-63769
				10	10	D-63769-10
				Z120	1	D-63775
				10	10	D-63775-10
				Z40	1	D-63781
				10	10	D-63781-10
		180	22.23	Z60	1	D-63797
				10	10	D-63797-10
				Z80	1	D-63806
				10	10	D-63806-10
				Z120	1	D-63812
				10	10	D-63812-10
115	22.23	Z40	1	D-63828		
		10	10	D-63828-10		
		Z60	1	D-63834		
		10	10	D-63834-10		
		Z80	1	D-63840		
		10	10	D-63840-10		
★★★★☆	Masonry	180	22.23	Z120	1	D-63856
				10	10	D-63856-10
				Z36	1	D-53718
				Z40	1	D-53724
				Z60	1	D-53730
★★★★☆	Masonry	115	22.23	Z80	1	D-53746
				Z120	1	D-53752

Flap disc zirconia aluminum/ Fiberglass backing/ Flat



Range	Material	Outer dia. mm	Inner dia. mm	Grit	Sales Pkg Qty	Part No.
★★★★☆	Stainless, Metal, Non-ferrous	100	16.00	Z40	1	D-74142
				Z60	1	D-74158
				Z80	1	D-74164
				Z120	1	D-74170
		115	22.23	Z40	1	D-74186
				Z60	1	D-74192
				Z80	1	D-74201
				Z120	1	D-74217
		125	22.23	Z40	1	D-74223
				Z60	1	D-74239
				Z80	1	D-74245
				Z120	1	D-74251
180	22.23	Z40	1	D-74267		
		Z60	1	D-74273		
		Z80	1	D-74289		
		Z120	1	D-74295		

Flap disc zirconia aluminum/ Fiberglass backing/ Angled with X-LOCK



Range	Material	Outer dia. mm	Thread mm	Grit	Sales Pkg Qty	Part No.
★★★★☆	Stainless, Metal, Non-ferrous	125	X-LOCK	Z36	1	D-75998
				Z40	1	D-76009
				Z60	1	D-76015
				Z80	1	D-76021
				Z120	1	D-76037

Flap disc silicon carbide/ Fiberglass backing/ Flat



Range	Material	Outer dia. mm	Inner dia. mm	Grit	Sales Pkg Qty	Part No.
★★★★☆	Masonry	100	16.00	C36	1	D-27975
				C40	1	D-27981
				C60	1	D-27997
				C80	1	D-28008
				C120	1	D-28014
		115	22.23	C36	1	D-28020
				C40	1	D-28036
				C60	1	D-28042
				C80	1	D-28058
				C120	1	D-28064
		125	22.23	C36	1	D-28070
				C40	1	D-28086
				C60	1	D-28092
				C80	1	D-28101
				C120	1	D-28117
		180	22.23	C36	1	D-28123
				C40	1	D-28139
				C60	1	D-28145
				C80	1	D-28151
				C120	1	D-28167

Flexible flap disc aluminum oxide/ Flat



High flexibility



Suitable for grinding on CURVE/EDGE/CORNER surface.



Range	Material	Outer dia. mm	Inner dia. mm	Grit	Sales Pkg Qty	Part No.
★★★★☆	Metal, Non-ferrous, PVC	100	16.00	A40	1	D-62686
				A60	1	D-62692
				A80	1	D-62701
				A120	1	D-62717

Strip disc
Special tool for stripping work

Grit (SiC)

It is covered with glue with Sic (Silicon Carbide), so it enables you to grind quickly with less power.

Fiber

Entangled fiber acts as a cushion material and prevents from grinding too much and scratching steel.

The surface condition of strip disc is the finest.

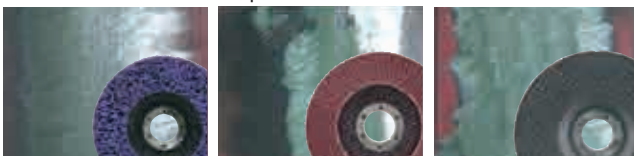

Removing Paint, Removing Rust, Removing blue weld discoloration



Strip disc/ Fiberglass backing/ Long life



Range	Material	Outer dia. mm	Inner dia. mm	Sales Pkg Qty	Part No.
★★★★☆	Metal, Stainless, Non-ferrous	100	16.00	1	B-29000
		115	22.23	1	B-29016
		125	22.23	1	B-29022
		180	22.23	1	B-29038

Strip disc/ Nylon backing/ Long life



Range	Material	Outer dia. mm	Inner dia. mm	Sales Pkg Qty	Part No.
★★★★☆	Metal, Stainless, Non-ferrous	100	16.00	1	B-36245
		115	22.23	1	B-36251
		125	22.23	1	B-36267
		180	22.23	1	B-36273

Strip disc/ Fiberglass backing



Range	Material	Outer dia. mm	Inner dia. mm	Sales Pkg Qty	Part No.
★★★★☆	Metal, Stainless, Non-ferrous	100	16.00	1	B-28961
		115	22.23	1	B-28977
		125	22.23	1	B-28983
		180	22.23	1	B-28999

Strip disc/ Nylon backing



Range	Material	Outer dia. mm	Inner dia. mm	Sales Pkg Qty	Part No.
★★★★☆	Metal, Stainless, Non-ferrous	100	16.00	1	B-29044
		115	22.23	1	B-29050
		125	22.23	1	B-29066
		180	22.23	1	B-36239

Surface conditioning flap disc

1. Grinding and surface conditioning of metal in one step.
2. Suitable for polishing after grinding by flap disc.
3. Usable for stainless and metal.

How to use



Removing blue weld discoloration Removing Rust

Polishing after grinding by flap disc

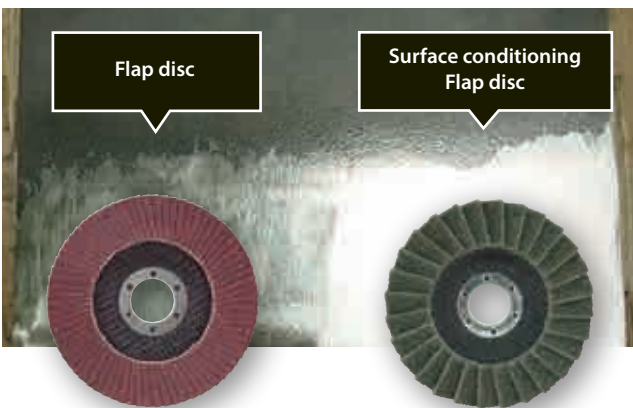

Surface conditioning flap disc/ Angled/ Fine



Range	Material	Outer dia. mm	Inner dia. mm	Sales Pkg Qty	Part No.
★★★★☆	Stainless, Metal, Non-ferrous, Paint	100	16.00	1	B-40733
		115	22.23	1	B-40777
		125	22.23	1	B-40814
		180	22.23	1	B-40858

Surface conditioning flap disc/ Angled/ Very fine



Range	Material	Outer dia. mm	Inner dia. mm	Sales Pkg Qty	Part No.
★★★★☆	Stainless, Metal, Non-ferrous, Paint	100	16.00	1	B-40749
		115	22.23	1	B-40783
		125	22.23	1	B-40820
		180	22.23	1	B-40864

Surface conditioning flap disc/ Flat/ Coarse



Range	Material	Outer dia. mm	Inner dia. mm	Sales Pkg Qty	Part No.
★★★★☆	Stainless, Metal, Non-ferrous, Paint	100	16.00	1	B-40870
		115	22.23	1	B-40917
		125	22.23	1	B-40951
		180	22.23	1	B-40995

Surface conditioning flap disc/ Angled/ Coarse



Range	Material	Outer dia. mm	Inner dia. mm	Sales Pkg Qty	Part No.
★★★★☆	Stainless, Metal, Non-ferrous, Paint	100	16.00	1	B-40711
		115	22.23	1	B-40755
		125	22.23	1	B-40799
		180	22.23	1	B-40836

Surface conditioning flap disc/ Flat/ Medium



Range	Material	Outer dia. mm	Inner dia. mm	Sales Pkg Qty	Part No.
★★★★☆	Stainless, Metal, Non-ferrous, Paint	100	16.00	1	B-40886
		115	22.23	1	B-40923
		125	22.23	1	B-40967
		180	22.23	1	B-41006

Surface conditioning flap disc/ Angled/ Medium



Range	Material	Outer dia. mm	Inner dia. mm	Sales Pkg Qty	Part No.
★★★★☆	Stainless, Metal, Non-ferrous, Paint	100	16.00	1	B-40727
		115	22.23	1	B-40761
		125	22.23	1	B-40808
		180	22.23	1	B-40842

Surface conditioning flap disc/ Flat/ Fine



Range	Material	Outer dia. mm	Inner dia. mm	Sales Pkg Qty	Part No.
★★★★☆	Stainless,	100	16.00	1	B-40892
	Metal, Non-	115	22.23	1	B-40939
	ferrous,	125	22.23	1	B-40973
	Paint	180	22.23	1	B-41012

Surface conditioning flap disc/ Flat/ Very fine



Range	Material	Outer dia. mm	Inner dia. mm	Sales Pkg Qty	Part No.
★★★★☆	Stainless,	100	16.00	1	B-40901
	Metal, Non-	115	22.23	1	B-40945
	ferrous,	125	22.23	1	B-40989
	Paint	180	22.23	1	B-41028

Flap wheel aluminum oxide with 6mm shank



Range	Material	Outer dia. mm	Shank mm	Grit	Sales Pkg Qty	Part No.	
★★★★☆	Wood, Metal, PVC	30.0	6.0	A40	1	D-75297	
			6.0	A60	1	D-75306	
			6.0	A80	1	D-75312	
			6.0	A120	1	D-75328	
		40.0	6.0	A40	1	D-75334	
			6.0	A60	1	D-75340	
			6.0	A80	1	D-75356	
			6.0	A120	1	D-75362	
		50.0	6.0	A40	1	D-75219	
			6.0	A40	1	D-75378	
			6.0	A40	1	D-75792	
			6.0	A60	1	D-75225	
			6.0	A60	1	D-75384	
			6.0	A60	1	D-75801	
			6.0	A80	1	D-75231	
			6.0	A80	1	D-75390	
			6.0	A80	1	D-75817	
			6.0	A120	1	D-75247	
			6.0	A120	1	D-75409	
			6.0	A120	1	D-75823	
		60.0	6.0	A40	1	D-75253	
			6.0	A40	1	D-75839	
			6.0	A60	1	D-75269	
			6.0	A60	1	D-75845	
			6.0	A80	1	D-75275	
			6.0	A80	1	D-75851	
				6.0	A120	1	D-75281
				6.0	A120	1	D-75867

Fiber sanding disc



Range	Work material	Size mm	Grit	Sales pkg q'ty	Part No.
★★★★☆	Metal	150x22	A80	25	B-66765-25
	Mortar	180x22	C50	25	B-66771-25
		180x22	C80	25	B-66787-25

Fiber sanding disc for wet



Range	Work material	Size mm	Grit	Model No.	Sales pkg q'ty	Part No.
★★★★☆	Marble, Granite	125x22	C24	PK5001C, PK5011C	10	B-14526
			C50		10	B-14532
			C80		10	B-14548
			C120		10	B-14554

Accessory for DPV300 / PV301D (Sander Polisher)

How to use

1. Use with adapter (743126-2)
2. Use with pad (743124-6)

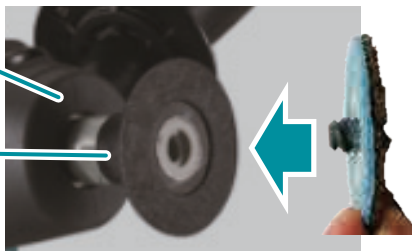

Fiber sanding disc for DPV300



Range	Work material	Dia mm	Grit	Fastening	Sales pkg q'ty	Part No.
★★★★☆	Metal, Stainless	50	A60	Use with adapter (Part No. 743126-2) and pad (Part No. 743124-6)	25	E-07412
			A80		25	E-07428
			A120		25	E-07434
			Z60		25	E-07440
			Z80		25	E-07456

Surface conditioning disc for DPV300



Range	Work material	Dia mm	Grit type	Grit	Fastening	Sales pkg q'ty	Part No.
★★★★☆	Paint	50	Hard	Coarse (A80)	Use with adapter (Part No. 743126-2) and pad (Part No. 743124-6)	25	E-07462
				Medium (A120)		25	E-07478
				Fine (A240)		25	E-07484
			Soft	Medium (A120)		25	E-07490
				Fine (A180)		25	E-07509
				Very fine (A320)		25	E-07515

Abrasive disc/ Wood



Range	Work material	Dia mm	Grit	Holes	Fastening	Sales pkg q'ty	Part No.					
★★★★☆		150	A40	15		10	B-51415					
			A60			10	B-51421					
			A80			10	B-51437					
			A100			10	B-51443					
			A120			10	B-51459					
			A180			10	B-51465					
			A240			10	B-51471					
			A320			10	B-51487					
			A400			10	B-51493					
			★★★★☆			Wood, Paint, Metal	125	A40	8	Hook & Loop	10	D-54134
								A40			50	D-54673
								A60			10	D-54140
								A60			50	D-54689
								A80			10	D-54156
								A80			50	D-54695
A100	10	D-54162										
A100	50	D-54704										
A120	10	D-54178										
A120	50	D-54710										
A150	10	D-54184										
A150	50	D-54726										
A180	10	D-54190										
A180	50	D-54732										
A240	10	D-54209										
A240	50	D-54748										
A320	10	D-54215										
A320	50	D-54754										
A60, A120, A240, A320	20	D-77229										
★★★★☆		150	A40	15		10	D-54586					
			A40			50	D-54760					
			A60			10	D-54592					
			A60			50	D-54776					
			A80			10	D-54601					
			A80			50	D-54782					
			A100			10	D-54617					
			A100			50	D-54798					
			A120			10	D-54623					
			A120			50	D-54807					
			A150			10	D-54639					
			A150			50	D-54813					
			A180			10	D-54645					
			A180			50	D-54829					
			A240			10	D-54651					
			A240			50	D-54835					
			A320			10	D-54667					
			A320			50	D-54841					
			A60, A120, A240, A320			20	D-77235					

Abrasive disc/ Wood/ Metal



Range	Work material	Dia mm	Grit	Holes	Fastening	Sales pkg q'ty	Part No.
★★★★☆	Wood, Paint, Metal	125	WA60	8	Hook & Loop	10	794542-1
			WA80			10	794543-9
			WA120			10	794544-7
			WA180			10	794545-5
			WA240			10	794546-3
			WA60			10	794608-7
		150	WA80	10		794609-5	
			WA120	10		794610-0	
			WA180	10		794611-8	
			WA240	10		794612-6	
			WA400	10		794613-4	

Abrasive disc/ Paint



Range	Work material	Dia mm	Grit	Holes	Fastening	Sales pkg q'ty	Part No.
★★★★☆	Paint, Wood, Metal	150	A40	15	Hook & Loop	10	B-51502
			A60			10	B-51518
			A80			10	B-51524
			A100			10	B-51530
			A120			10	B-51546
			A180			10	B-51552
			A240			10	B-51568
			A320			10	B-51574
			A400			10	B-51580
			★★★★☆			Paint, Wood, Metal	125
A60	10	D-65822					
A80	10	D-65838					
A100	10	D-65844					
A120	10	D-65850					
A150	10	D-65866					
A180	10	D-65872					
A240	10	D-65888					
A320	10	D-65894					
A400	10	D-65903					

Abrasive disc/ Drywall



Range	Work material	Dia mm	Grit	Holes	Fastening	Sales pkg q'ty	Part No.
★★★★☆	Drywall	225	A40	9	Hook & Loop	25	B-68389
			A80			25	B-68395
			A120			25	B-68404
			A150			25	E-02375
			A180			25	B-68410
			A220			25	E-02381
			A320			25	B-68426

Abrasive belt/ Wood



Range	Work material	Size mm	Grit	Sales pkg q'ty	Part No.
★★★★☆	Wood, Paint, Metal	30x533	A40	5	D-67066
			A60	5	D-67072
			A80	5	D-67088
			A100	5	D-67094
			A120	5	D-67103
			A150	5	D-67119
		76x457	A180	5	D-67125
			A240	5	D-67131
			A40	3	D-59184
			A60	3	D-59190
			A80	3	D-59209
			A100	3	D-59215
			A120	3	D-59221
			A150	3	D-59237
		76x533	A180	3	D-59243
			A240	3	D-59259
			A40	3	D-59265
			A60	3	D-59271
			A80	3	D-59287
			A100	3	D-59293
			A120	3	D-59302
			A150	3	D-59318
		76x610	A180	3	D-59324
			A240	3	D-59330
			A40	3	D-67147
			A60	3	D-67153
			A80	3	D-67169
			A100	3	D-67175
			A120	3	D-67181
			A150	3	D-67197
			A180	3	D-67206
			A240	3	D-67212
		100x610	A40	3	D-59346
			A60	3	D-59352
			A80	3	D-59368
			A100	3	D-59374
			A120	3	D-59380
			A150	3	D-59396
			A180	3	D-59405
			A240	3	D-59411

Abrasive belt/ Wood/ Metal



Range	Work material	Size mm	Grit	Sales pkg q'ty	Part No.
★★★★☆	Metal, Wood, Paint	6x533	A40	10	A-34512
			A60	10	A-34528
			A80	10	A-34534
			A100	10	A-34540
			A120	10	A-34556
		9x533	A40	10	A-34447
			A60	10	A-34453
			A80	10	A-34469
			A100	10	A-34475
			A120	10	A-34481
		13x533	A40	10	A-34562
			A60	10	A-34578
			A80	10	A-34584
			A100	10	A-34590
			A120	10	A-34609

Range	Work material	Size mm	Grit	Sales pkg q'ty	Part No.
★★★★☆	Metal, Wood, Paint	30x533	A40	10	A-23852
			A60	10	A-23868
			A80	10	A-23874
			A100	10	A-23880
			A120	10	A-23896
			A150	10	A-23905
		76x457	WA80	10	794551-0
			WA60	10	794120-7
		76x533	WA150	10	794242-3
			WA180	10	794243-1
		100x610	WA240	10	794244-9
			WA40	5	794133-8
			WA60	5	794134-6
			WA80	5	794135-4
			WA100	5	794136-2
			WA120	5	794137-0
WA150	5		794138-8		
WA180	5		794222-9		
WA240	5	794139-6			

Abrasive belt/ Stone/ Plastic



Range	Work material	Size mm	Grit	Sales pkg q'ty	Part No.
★★★★☆	Stone, Plastics	30x533	C40	10	A-23927
			C60	10	A-23933
			C80	10	A-23949
			C100	10	A-23955
			C120	10	A-23961
			C150	10	A-23977
			C240	10	A-23983

Abrasive paper/ Wood



Range	Work material	Size mm	Grit	Holes	Fastening	Sales pkg q'ty	Part No.
★★★★☆	Wood, Paint, Metal	114x102	A40	6	Hook & Loop	10	D-58665
			A60			10	D-58671
			A80			10	D-58687
			A100			10	D-58693
			A120			10	D-58702
			A150			10	D-58718
			A180			10	D-58724
			A240			10	D-58730
			A320			10	D-58746

Abrasive paper/ Wood/ Metal



Range	Work material	Size mm	Grit	Holes	Fastening	Sales pkg q'ty	Part No.		
★★★★☆	Wood, Metal, Paint	93x228	WA60	-	Clamp	10	794156-6		
			WA60	8		10	A-31245		
			WA80	-		10	794471-8		
			WA80	8		10	A-31251		
			WA100	-		10	794157-4		
			WA120	8		10	A-31267		
			WA150	-		10	794158-2		
			WA180	8		10	A-31273		
			WA240	8		10	A-31289		
			114x140	WA60		-	10	794216-460	
				WA80		-	10	794469-5	
				WA100		-	10	794215-660	
				WA150		-	10	794214-8	
				114x280		WA60	-	10	794210-6
						WA80	-	10	794470-0
						WA100	-	10	794209-1
		WA120			-	10	794212-2		
		115x232	WA150	-	10	794213-0			
			WA180	-	10	794211-4			
			WA60	-	5	A-14130			
			WA80	-	5	A-14146			
			WA100	-	5	A-14152			
			WA120	-	5	A-14168			
			WA150	-	5	A-14174			
			WA180	-	5	A-14180			
			115x280	WA240	-	5	A-14196		
				WA60	-	10	A-14065		
				WA80	-	10	A-14071		
				WA100	-	10	A-14087		
		WA120		-	10	A-14093			
		WA150		-	10	A-14102			
		WA180		-	10	A-14118			
WA240	-	10		A-14124					

Abrasive paper/ Paint

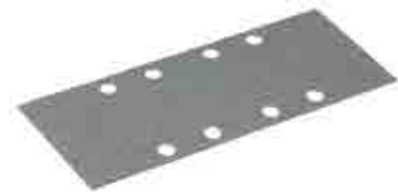

Range	Work material	Size mm	Grit	Holes	Fastening	Sales pkg q'ty	Part No.
★★★★☆	Paint, Wood, Metal	93x228	A40	-	Clamp	10	E-18041
			A60			10	E-18057
			A80			10	E-18063
			A100			10	E-18079
			A120			10	E-18085
			A150			10	E-18091
			A180			10	E-18100
			A240			10	E-18116
		115x280	A40	14		10	E-18122
			A60			10	E-18138
			A80			10	E-18144
			A100			10	E-18150
			A120			10	E-18166
			A150			10	E-18172
★★☆☆☆	Paint, Wood, PVC	93x228	A180	8	10	E-18188	
			A240		10	E-18194	
			A80		10	D-65252	
			A100		10	D-65268	
			A120		10	D-65274	
			A180		10	D-65280	
			A240		10	D-65296	
A320	10	D-65305					

Range	Work material	Size mm	Grit	Holes	Fastening	Sales pkg q'ty	Part No.
★★★★★	Paint, Wood, PVC	114x140	A80	6	Clamp	10	D-65311
			A100			10	D-65327
			A120			10	D-65333
			A180			10	D-65349
			A240			10	D-65355
			A320			10	D-65361

Abrasive paper 230mm x 280mm (9" x 11")

How to use



Abrasive paper sheet/ Wood



Range	Work material	Size mm	Grit	Fastening	Sales pkg q'ty	Part No.
★★★★★	Wood	230x280	A40	Clamp	10	D-66313
			A40		50	D-51683
			A60		10	D-66329
			A60		50	D-51699
			A80		10	D-66335
			A80		50	D-51708
			A100		10	D-66341
			A100		50	D-51714
			A120		10	D-66357
			A120		50	D-51720
			A150		10	D-66363
			A150		50	D-51736
			A180		10	D-66379
			A180		50	D-51742
			A240		10	D-66385
			A240		50	D-51758
			A320		10	D-66391
			A320		50	D-56873
A400	10	D-66400				
A400	50	D-56889				

Abrasive paper sheet/ Metal



Range	Work material	Size mm	Grit	Fastening	Sales pkg q'ty	Part No.
★★★★★	Metal	230x280	A36	Clamp	10	D-66488
			A36		50	D-56677
			A40		10	D-66494
			A40		50	D-56683
			A60		10	D-66503
			A60		50	D-56699
			A80		10	D-66519
			A80		50	D-56708
			A100		10	D-66525
			A100		50	D-56714
			A120		10	D-66531

Range	Work material	Size mm	Grit	Fastening	Sales pkg q'ty	Part No.
★★★★★	Metal	230x280	A120	Clamp	50	D-56720
			A150		10	D-66547
			A150		50	D-56736
			A180		10	D-66553
			A180		50	D-56742
			A240		10	D-66569
			A240		50	D-56758

Abrasive paper sheet/ Mortar



Range	Work material	Size mm	Grit	Fastening	Sales pkg q'ty	Part No.
★★★★★	Mortar	230x280	A60	Clamp	10	D-66416
			A60		50	D-56530
			A80		10	D-66422
			A80		50	D-56546
			A100		10	D-66438
			A100		50	D-56552
			A120		10	D-66444
			A120		50	D-56568
			A150		10	D-66450
			A150		50	D-56574
			A180		10	D-66466
			A180		50	D-56580
			A240		10	D-66472
			A240		50	D-56596

Abrasive paper sheet/ Paint



Range	Work material	Size mm	Grit	Fastening	Sales pkg q'ty	Part No.
★★★★★	Paint, Wood, PVC	230x280	A80	Clamp	10	D-66086
			A80		100	D-60698
			A100		10	D-66092
			A100		100	D-60707
			A120		10	D-66101
			A120		100	D-60713
			A150		10	D-66117
			A150		100	D-60729
			A180		10	D-66123
			A180		100	D-60735
			A240		10	D-66145
			A240		100	D-60757
			A320		100	D-60779
			A400		100	D-60791

Abrasive paper sheet/ Carbody/ Waterproof

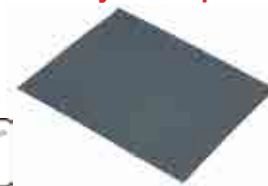

Range	Work material	Size mm	Grit	Fastening	Sales pkg q'ty	Part No.
★★★★★	Paint, Metal, Stainless, PVC	230x280	C120	Clamp	10	D-66189
			C120		50	D-58964
			C180		10	D-66204
			C180		50	D-58986
			C280		10	D-66226
			C280		50	D-59003
			C320		10	D-66232

Range	Work material	Size mm	Grit	Fastening	Sales pkg q'ty	Part No.
★★★★☆	Paint, Metal, Stainless, PVC	230x280	C320	Clamp	50	D-59019
			C600		10	D-66254
			C600		50	D-59031
			C800		10	D-66260
			C800		50	D-59047
			C1000		10	D-66276
			C1000		50	D-59053
			C1500		10	D-66298
			C1500		50	D-59069
			C2000		10	D-66307
			C2000		50	D-59075

Abrasive delta paper/ Wood



Range	Work material	Size mm	Grit	Fastening	Sales pkg q'ty	Part No.
★★★★☆	Wood, Paint, Metal	94	A60, A80, A120, A180, A240	Hook & Loop	10	B-21618
			A60		10	B-21624
			A80		10	B-21630
			A100		10	B-22947
			A120		10	B-21646
			A150		10	B-22953
			A180		10	B-21652
★★★★☆	Wood, Paint, Metal	93	A240	Hook & Loop	10	B-21668
			A40		10	D-58578
			A60		10	D-58584
			A80		10	D-58590
			A100		10	D-58609
			A120		10	D-58615
			A150		10	D-58621
★★★★☆	Wood, Paint, Metal	93	A180	Hook & Loop	10	D-58637
			A240		10	D-58643
			A320		10	D-58659
			A320		10	D-58659

Abrasive delta paper/ Wood/ long-life



Range	Work material	Size mm	Grit	Fastening	Sales pkg q'ty	Part No.
★★★★☆	Wood, Paint, Metal	94	A60, A80, A100, A120, A180	Hook & Loop	10	B-21559
			A60		10	B-21565
			A80		10	B-21571
			A100		10	B-21587
			A120		10	B-21593
			A180		10	B-21602
			A240		10	B-22931

Abrasive delta paper/ Paint



Range	Work material	Size mm	Grit	Fastening	Sales pkg q'ty	Part No.
★★★★☆	Paint, Wood, Metal	94	A60, A80, A100, A240, A320	Hook & Loop	10	B-21674
			A60		10	B-21680
			A80		10	B-21696

Range	Work material	Size mm	Grit	Fastening	Sales pkg q'ty	Part No.
★★★★☆	Paint, Wood, Metal	94	A100	Hook & Loop	10	B-21705
			A120		10	B-22969
			A240		10	B-21711
			A320		10	B-21727

Abrasive delta paper/ Stone



Range	Work material	Size mm	Grit	Fastening	Sales pkg q'ty	Part No.
★★★★☆	Marble	94	C120, C240, C400, C600, C1200	Hook & Loop	10	B-21733
			C120		10	B-21749
			C240		10	B-21755
			C400		10	B-21761
			C600		10	B-21777
			C1200		10	B-21783

Abrasive delta paper/ Polishing fleece



Range	Work material	Size mm	Grit	Fastening	Sales pkg q'ty	Part No.
★★★★☆	Wood, Metal, PVC, Paint	94	-	Hook & Loop	1	B-21814
	Metal, Non-ferrous metal, PVC, Paint		A100		1	B-21808
	Wood, Metal, Non-ferrous metal, PVC		A280		1	B-21799

Abrasive delta paper/ Polishing felt



Range	Work material	Size mm	Fastening	Sales pkg q'ty	Part No.
★★★★☆	Perspex, Non-ferrous metal, Glass	94	Hook & Loop	1	B-21820

Abrasive paper for JR1000FT



For Sanding adapter (A-40967)

Range	Work material	Size mm	Grit	Fastening	Sales pkg q'ty	Part No.
★★★★☆	Wood	22x95	A120	Hook & Loop	10	B-04983

ACCESSORIES

Multi Tool



Hook and loop type



Precise



Blade thickness
2.0mm



Blade thickness
3.0mm

Multi Tool

STARLOCK



Rating Suitability for application:
 ✓ = Suitable
 Blank = No Rating

Color coding for application



Wood & Metal



Wood



Metal



Multi Material



Grout Abrasive

Width (mm)	Teeth per inch	Blade Material	Curve Teeth
------------	----------------	----------------	-------------

TMA Code	Width (mm)	Teeth per inch	Blade Material	Curve Teeth
TMA045	85	18	BiM	
TMA046	100	15	BiM	
TMA047	32	20	BiM	•
TMA048	65	20	BiM	•
TMA057	10	20	BiM	
TMA058	20	20	BiM	
TMA049	85	18	HCS	
TMA050	24	18	HCS	
TMA051	32	18	HCS	•
TMA052	65	20	HCS	•
TMA053	32	14	BiM	•
TMA054	32	14	HCS	•
TMA055	65	14	BiM	•
TMA056	65	14	HCS	•
TMA059	32	20	BiM	
TMA060	20	23	TC	
TMA061	32	23	TC	
TMA079	45	23	TC	
TMA063	100	-	BiM	
TMA064	85	18	BiM	
TMA065	52	-	HCS	
TMA066	52	-	HCS	
TMA067	28	-	HCS	
TMA068	11	-	HCS	
TMA080	32	20	TC	•
TMA081	53	14	BiM	•
TMA082	12	-	Stainless	
TMA069	85	-	TC #30	
TMA070	85	-	Diamond	
TMA071	70	-	TC #50	
TMA072	85	-	TC #40	
TMA073	78	-	TC #20	
TMA074	70	-	TC #40	
TMA075	32	-	TC #50	
TMA076	32	-	TC #40	
TMA077	32	-	TC #100	
TMA083	90	-	TC #20	
TMA084	90	-	TC #40	
TMA085	90	-	TC #60	
TMA086	90	-	TC #100	

Wood & Metal								
Wood					Metal			
Wood	Plywood	Chipboard	Laminate	Plaster board	Non ferrous metal	Sheet metal	Stainless	Soft nail
✓	✓	✓	✓	✓	✓	✓		✓
✓	✓	✓	✓	✓	✓			✓
✓	✓	✓	✓	✓	✓	✓		✓
✓	✓	✓	✓	✓	✓	✓		✓
✓	✓	✓	✓	✓	✓	✓		✓
✓	✓	✓	✓	✓	✓	✓		✓
✓	✓	✓	✓					
✓	✓	✓	✓					
✓	✓	✓	✓	✓				
✓	✓	✓	✓	✓				
✓	✓	✓	✓	✓	✓	✓		✓
✓	✓	✓	✓	✓	✓	✓	✓	✓
✓	✓	✓	✓	✓	✓	✓	✓	✓
✓	✓	✓	✓	✓	✓	✓	✓	✓
✓	✓	✓	✓	✓	✓	✓		✓
✓	✓	✓	✓	✓	✓	✓	✓	✓
✓		✓		✓				
				✓				
				✓				
				✓				
✓								
✓				✓				
✓	✓							
✓	✓							
✓	✓	✓						
✓	✓	✓						
✓								
✓								

Multi Tool

STARLOCK PLUS **STARLOCK MAX**



Rating Suitability for application:
 ✓ = Suitable
 Blank = No Rating

Color coding for application

Width (mm)	Teeth per inch	Blade Material	Curve Teeth
------------	----------------	----------------	-------------

Wood & Metal								
Wood					Metal			
Wood	Plywood	Chipboard	Laminate	Plaster board	Non ferrous metal	Sheet metal	Stainless	Soft nail

STARLOCK PLUS



Wood & Metal

MAP001	32	20	BiM	●
MAP002	65	20	BiM	●

✓	✓	✓	✓	✓	✓	✓		✓
✓	✓	✓	✓	✓	✓	✓		✓



Wood

MAP003	32	18	HCS	●
--------	----	----	-----	---

✓	✓	✓	✓					
---	---	---	---	--	--	--	--	--



Metal

MAP004	32	23	TC	
MAP005	45	23	TC	

✓	✓	✓	✓	✓	✓	✓	✓	✓
✓	✓	✓	✓	✓	✓	✓	✓	✓



Multi Material

MAP006	32	20	TC	●
MAP007	52	20	TC	●

✓	✓	✓	✓	✓	✓	✓	✓	✓
✓	✓	✓	✓	✓	✓	✓	✓	✓



Grout Abrasive

MAP008	53	-	TC #40	
--------	----	---	--------	--

✓		✓		✓	✓			✓
---	--	---	--	---	---	--	--	---

STARLOCK MAX



Wood & Metal

MAM001	32	20	BiM	●
MAM002	52	18	BiM	●
MAM003	100	15	BiM	

✓	✓	✓	✓	✓	✓	✓		✓
✓	✓	✓	✓	✓	✓	✓		✓
✓	✓	✓	✓		✓			✓



Wood

MAM004	32	18	HCS	●
--------	----	----	-----	---

✓	✓	✓	✓					
---	---	---	---	--	--	--	--	--



Metal

MAM005	32	23	TC	
--------	----	----	----	--

✓	✓	✓	✓	✓	✓	✓	✓	✓
---	---	---	---	---	---	---	---	---



Multi Material

MAM006	32	20	TC	●
MAM007	32	-	HCS	
MAM008	32	-	HCS	

✓	✓	✓	✓	✓	✓	✓	✓	✓

MAM009	68	-	TC #50	
MAM010	68	-	TC #30	
MAM011	68	-	Diamond	
MAM012	68	-	Diamond	
MAM013	68	-	TC #40	
MAM014	100	-	TC #40	
MAM015	116	-	TC #20	
MAM016	116	-	TC #40	
MAM017	116	-	TC #60	
MAM018	116	-	TC #100	

				✓				
				✓				
				✓				
				✓				
				✓				
✓	✓			✓	✓			✓
✓	✓	✓						
✓	✓	✓						
✓	✓	✓						



Grout Abrasive



Multi Material						Grout Abrasive		
Epoxy	Fiber glass	Linoleum Carpet	Carpet adhesive	Insulation material	Soft joint material	Porous Concrete Soft brick	Soft wall tiles	Mortar Tile adhesive

Curve Teeth	Blade Material	Teeth per inch	Width (mm)
-------------	----------------	----------------	------------

Color coding for application

✓	✓							
✓	✓							

•	BiM	20	32	MAP001
•	BiM	20	65	MAP002

Wood & Metal



✓								
---	--	--	--	--	--	--	--	--

•	HCS	18	32	MAP003
---	-----	----	----	--------

Wood



✓	✓					✓		
✓	✓							

	TC	23	32	MAP004
	TC	23	45	MAP005

Metal



✓	✓					✓		
✓	✓					✓		

•	TC	20	32	MAP006
•	TC	20	52	MAP007

Multi Material



✓						✓		
---	--	--	--	--	--	---	--	--

	TC #40	-	53	MAP008
--	--------	---	----	--------

Grout Abrasive



✓	✓							
✓	✓							
✓								

•	BiM	20	32	MAM001
•	BiM	18	52	MAM002
	BiM	15	100	MAM003

Wood & Metal



--	--	--	--	--	--	--	--	--

•	HCS	18	32	MAM004
---	-----	----	----	--------

Wood



✓	✓					✓		
---	---	--	--	--	--	---	--	--

	TC	23	32	MAM005
--	----	----	----	--------

Metal



✓	✓					✓		
					✓			
				✓	✓			

•	TC	20	32	MAM006
	HCS	-	32	MAM007
	HCS	-	32	MAM008

Multi Material



✓	✓					✓	✓	✓
✓	✓					✓	✓	✓
✓	✓					✓	✓	✓
✓	✓					✓	✓	✓
✓	✓					✓	✓	✓
✓	✓					✓		✓
	✓							✓
	✓							✓

	TC #50	-	68	MAM009
	TC #30	-	68	MAM010
	Diamond	-	68	MAM011
	Diamond	-	68	MAM012
	TC #40	-	68	MAM013
	TC #40	-	100	MAM014
	TC #20	-	116	MAM015
	TC #40	-	116	MAM016
	TC #60	-	116	MAM017
	TC #100	-	116	MAM018

Grout Abrasive



STARLOCK

Compatibility with models		Blade Shank		
		STARLOCK	STARLOCK PLUS	STARLOCK MAX
Tool Shank	OIS Compatible Tools	✓	-	-
	STARLOCK MAX	✓	✓	✓

Segment saw blade Starlock shank Wood and metal

Range	Makita No.	Blade Width mm	Tpi	Material of Blade	Material	Sales Pkg Qty	Part No.
★★★☆☆	TMA045	85	18TPI	BiM	Wood and Metal	1	B-64799
	TMA046	100	15TPI			1	B-64808

Plunge cut saw blade Starlock shank Wood and metal

Range	Makita No.	Blade Width mm	Tpi	Material of Blade	Note	Material	Sales Pkg Qty	Part No.
★★★☆☆	TMA047	32x50	20TPI	BiM	Bow shape	Wood and Metal	1	B-64814
							5	B-64814-5
							20	B-64814-20
★★★☆☆	TMA048	65x40	20TPI	BiM		Wood and Metal	1	B-64820
							5	B-64820-5
★★★☆☆	TMA057	10x30					1	B-64917
	TMA058	20x30					1	B-64923
							5	B-64923-5

Segment saw blade Starlock shank Wood

Range	Makita No.	Blade Width mm	Tpi	Material of Blade	Material	Sales Pkg Qty	Part No.
★★★☆☆	TMA049	85	18TPI	HCS	Wood	1	B-64836

Plunge cut saw blade Starlock shank Wood

Range	Makita No.	Blade Width mm	Tpi	Material of Blade	Material	Sales Pkg Qty	Part No.	
★★★☆☆	TMA050	24x50	18TPI	HCS	Wood	1	B-64842	
						5	B-64842-5	
	TMA051	32x50				1	B-64858	
						5	B-64858-5	
						20	B-64858-20	
TMA052	65x40	20TPI	1	B-64864				
			5	B-64864-5				
★★★☆☆	TMA053	32x50	14TPI	BiM	Hard wood	1	B-64870	
						5	B-64870-5	
	TMA054					HCS	1	B-64886
						5	B-64886-5	
	TMA055	65x40				BiM	1	B-64892
						5	B-64892-5	
TMA056		HCS	1	B-64901				
			5	B-64901-5				

Plunge cut saw blade Starlock shank Metal

Range	Makita No.	Blade Width mm	Tpi	Material of Blade	Material	Sales Pkg Qty	Part No.
★★★☆☆	TMA059	32x50	20TPI	BiM	Metal	1	B-64939
						5	B-64939-5

TC bar plunge cut saw blade Starlock shank Metal

Range	Makita No.	Blade Width mm	Tpi	Material of Blade	Material	Sales Pkg Qty	Part No.
★★★☆☆	TMA060	20x40	23TPI	TC/HM	Metal	1	B-64945
						5	B-64945-5
	TMA061	32x40				1	B-64951
						5	B-64951-5
TMA079	45x49			1	B-69755		

Segment saw blade Starlock shank Multi material

Range	Makita No.	Blade Width mm	Tpi	Material of Blade	Material	Sales Pkg Qty	Part No.
★★★☆☆	TMA064	85	18TPI	BiM-TiN	Plaster board, Fiberglass, Wood with nail, Metal,epoxy	1	B-64973

Serrated segment blade Starlock shank Multi material



Range	Makita No.	Blade Width mm	Material of Blade	Material	Sales Pkg Qty	Part No.
★★★★☆	TMA063	100	BiM	Insulation, Carpet	1	B-64967

Universal purpose knife Starlock shank Multi material

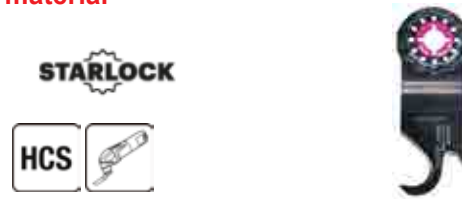

Range	Makita No.	Blade Width mm	Material of Blade	Material	Sales Pkg Qty	Part No.
★★★★☆	TMA068	11x24	HCS	Insulation, Carpet	1	B-65012

Plunge and segment cut saw blade Starlock shank Multi material



Range	Makita No.	Blade Width mm	Tpi	Material of Blade	Material	Sales Pkg Qty	Part No.
★★★★☆	TMA081	53x40	14TPI	BiM	Plaster board, Plywood, Wood, Epoxy	1	B-69777

Scraper blade Starlock shank Multi material

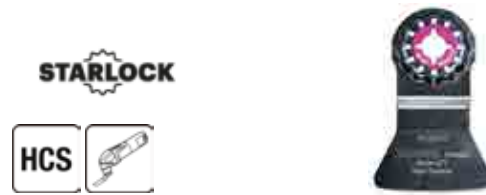

Range	Makita No.	Blade Width mm	Material of Blade	Note	Sales Pkg Qty	Part No.
★★★★☆	TMA065	52x26	HCS	Rigid	1	B-64989
	TMA066	52x40	HCS	Flexible	1	B-64995

TC bar plunge cut saw blade Starlock shank Multi material

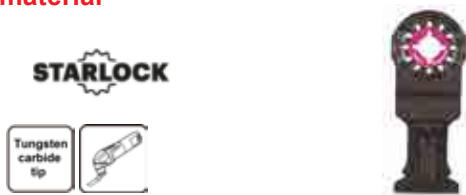

Range	Makita No.	Blade Width mm	Tpi	Material of Blade	Note	Material	Sales Pkg Qty	Part No.
★★★★☆	TMA080	32x40	20TPI	TC/HM	Bow shape	Plaster board, Fiberglass, Epoxy, Aluminum, Stainless, Wood with nail, Metal	1	B-69761

TC segment blade Starlock shank Grout abrasive



Range	Makita No.	Blade Width mm	Material of Blade	Note	Material	Sales Pkg Qty	Part No.
★★★★☆	TMA069	85	TC/HM #30	Blade thickness 2.5mm	Grout and mortar remover	1	B-65028
	TMA071	70	TC/HM #50	Blade thickness 1.6mm		1	B-65040
	TMA072	85	TC/HM #40	Blade thickness 1.7mm		1	B-65056

Joint cutter blade Starlock shank Multi material





Range	Makita No.	Blade Width mm	Material of Blade	Material	Sales Pkg Qty	Part No.
★★★★☆	TMA067	28x40	HCS	Silicon, Insulation	1	B-65006
	TMA082	12x29	Stainless	Silicon	5	B-65006-5
					1	B-69783

Diamond segment blade Starlock shank Grout abrasive

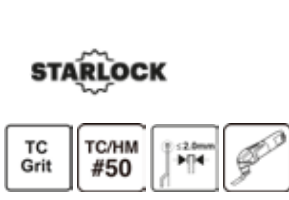

Range	Makita No.	Blade Width mm	Material of Blade	Note	Material	Sales Pkg Qty	Part No.
★★★★☆	TMA070	85	Diamond #40	Blade thickness 2mm	Grout and mortar remover	1	B-65034

TC plunge blade Starlock shank Grout abrasive



Range	Makita No.	Blade Width mm	Material of Blade	Note	Material	Sales Pkg Qty	Part No.
★★★★☆	TMA075	32x30	TC/HM #50	Blade thickness 2mm	Grout and mortar remover	1	B-65084

Sanding pad for abrasive paper delta Starlock shank

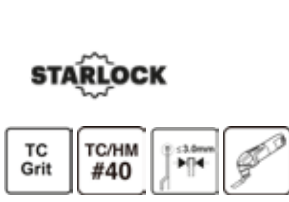

Range	Makita No.	Blade Width mm	Sales Pkg Qty	Part No.
★★★★☆	TMA078	93	1	B-65115

TC remover Starlock shank Grout abrasive



Range	Makita No.	Blade Width mm	Material of Blade	Note	Material	Sales Pkg Qty	Part No.
★★★★☆	TMA074	70	TC/HM #40	Blade thickness 3mm	Grout and mortar remover	1	B-65078

Multi tool blade Starlock shank assortment



Range	Makita No.	Note	Material	Sales Pkg Qty	Part No.
★★★★☆	TMA045, TMA047, TMA053, 2xTMA078	Carpentry set	Wood and Metal, Hard Wood	5	B-67511
	TMA045, TMA047, TMA053, TMA058	Plunge set	Wood and Metal, Hard Wood, Metal	4	B-67480
	TMA045, TMA048, TMA051, TMA066	Floor set	Wood and Metal, Wood, Multi Material	4	B-67505
	TMA058, TMA065, TMA069, TMA073	Tile set	Metal, Multi Material, Grout and mortar remover	4	B-67496

TC sanding plate Starlock shank Grout abrasive Delta shape

Range	Makita No.	Blade Width mm	Material of Blade	Note	Material	Sales Pkg Qty	Part No.
★★★★☆	TMA073	78	TC/HM #20	-	Grout and mortar remover	1	B-65062
	TMA083	90	TC/HM #40			1	B-69799
	TMA084		TC/HM #60			1	B-69808
	TMA085	TC/HM #100	Use only wood	Wood	1	B-69814	
	TMA086		1	B-69820			

TC sanding plate Starlock shank Grout abrasive Pointer shape



Range	Makita No.	Blade Width mm	Material of Blade	Material	Sales Pkg Qty	Part No.
★★★★☆	TMA076	32x50	TC/HM #40	Grout and mortar remover	1	B-65090
	TMA077		TC/HM #100		1	B-65109

Abrasive delta paper (Page 132) applications



Rating Suitability for application

- AA : Recommended
- A : Acceptable
- n.r : No Rating

Product Application and Rating On Each Material		Grit	Paint	Varnish	Filler	Roughcast	Wood / Wooden materials	soft wood	hard wood	Plywood	Chipboard/MDF	Metal	Steel (mild steel / carbon steel)	Stone	Marble	Granite	Glass	Perspex	Corian®	Glass fiber reinforced	
Wood / long-life	Coarse	60	n.r	n.r	n.r	n.r	AA	AA	AA	AA	AA	AA	A	n.r	n.r	n.r	n.r	n.r	n.r	n.r	n.r
		80																			
	Medium	100																			
		120																			
	Fine	180																			
		240																			
Wood (★★★)	Coarse	60	n.r	n.r	n.r	n.r	AA	A	AA	AA	AA	n.r	n.r	n.r	n.r	n.r	n.r	n.r	n.r	n.r	n.r
		80																			
	Medium	100																			
		120																			
	Fine	150																			
180																					
		240																			
Wood (★★)	Coarse	40	A	A	n.r	n.r	AA	AA	AA	AA	A	A	A	n.r	n.r	n.r	n.r	n.r	n.r	n.r	n.r
		60																			
		80																			
	Medium	100																			
		120																			
		150																			
	Fine	180																			
		240																			
		320																			
Paint	Coarse	60	AA	AA	AA	AA	n.r	n.r	A	n.r	n.r	A	A	n.r	n.r	n.r	n.r	n.r	n.r	n.r	n.r
		80																			
	Medium	100																			
		120																			
	Fine	240																			
320																					
Stone	Medium	120	A	AA	n.r	n.r	n.r	n.r	n.r	n.r	n.r	n.r	n.r	A	A	A	A	A	A	A	A
		240																			
	Fine	400																			
		600																			
	Very fine	1200																			



STARLOCK PLUS

Compatibility with models		Blade Shank		
		STARLOCK	STARLOCK PLUS	STARLOCK MAX
Tool Shank	OIS Compatible Tools	✓	-	-
	STARLOCK MAX	✓	✓	✓

Plunge cut saw blade Starlock plus shank Wood and metal

STARLOCK PLUS



Range	Makita No.	Blade Width mm	Tpi	Material of Blade	Note	Material	Sales Pkg Qty	Part No.
★★★☆☆	MAP001	32x60	20TPI	BIM	Bow shape	Wood and metal	1	B-66329
★★★☆☆	MAP002	65x50					1	B-66335

Plunge cut saw blade Starlock plus shank Wood

STARLOCK PLUS



Range	Makita No.	Blade Width mm	Tpi	Material of Blade	Note	Material	Sales Pkg Qty	Part No.
★★★☆☆	MAP003	32x60	18TPI	HCS	Bow shape	Wood	1	B-66341

TC bar plunge cut saw blade Starlock plus shank Metal

STARLOCK PLUS



Range	Makita No.	Blade Width mm	Tpi	Material of Blade	Material	Sales Pkg Qty	Part No.
★★★☆☆	MAP004	32x50	23TPI	TC/HM	Metal	1	B-66357
★★★☆☆	MAP005	45x50	23TPI	TC/HM	Metal	1	B-66363

TC bar plunge cut saw blade Starlock plus shank Multi material

STARLOCK PLUS



Range	Makita No.	Blade Width mm	Tpi	Material of Blade	Note	Material	Sales Pkg Qty	Part No.
★★★☆☆	MAP006	32x50	20TPI	TC/HM	Bow shape	Epoxy, Stainless, Metal,	1	B-66379
★★★☆☆	MAP007	52x50				Plasterboard, Fiberglass, Limestone	1	B-66385

TC plunge and segment blade Starlock plus shank Grout abrasive

STARLOCK PLUS



Range	Makita No.	Blade Width mm	Material of Blade	Material	Sales Pkg Qty	Part No.
★★★☆☆	MAP008	53x40	TC/HM #40	Porous concrete	1	B-66391

STARLOCK MAX

Compatibility with models		Blade Shank		
		STARLOCK	STARLOCK PLUS	STARLOCK MAX
Tool Shank	OIS Compatible Tools	✓	-	-
	STARLOCK MAX	✓	✓	✓

Segment saw blade Starlock max shank Wood and metal

STARLOCK MAX



Range	Makita No.	Blade Width mm	Tpi	Material of Blade	Material	Sales Pkg Qty	Part No.
★★★☆☆	MAM003	100x50	15TPI	BIM	Wood and metal	1	B-66422

Plunge cut saw blade Starlock max shank Wood and metal

STARLOCK MAX



Range	Makita No.	Blade Width mm	Tpi	Material of Blade	Note	Material	Sales Pkg Qty	Part No.
★★★☆☆	MAM001	32x80	20TPI	BIM	Bow shape	Wood and metal	1	B-66400
							5	B-66400-5
	MAM002	52x70	18TPI				1	B-66416
						5	B-66416-5	

Plunge cut saw blade Starlock max shank Wood

STARLOCK MAX



Range	Makita No.	Blade Width mm	Tpi	Material of Blade	Note	Material	Sales Pkg Qty	Part No.
★★★☆☆	MAM004	32x80	18TPI	HCS	Bow shape	Wood	1	B-66438
							5	B-66438-5

TC bar plunge cut saw blade Starlock max shank Metal

STARLOCK MAX



Range	Makita No.	Blade Width mm	Tpi	Material of Blade	Material	Sales Pkg Qty	Part No.
★★★☆☆	MAM005	32x70	23TPI	TC/HM	Metal	1	B-66444

TC bar plunge cut saw blade Starlock max shank Multi material

STARLOCK MAX



Range	Makita No.	Blade Width mm	Tpi	Material of Blade	Note	Material	Sales Pkg Qty	Part No.
★★★☆☆	MAM006	32x70	20TPI	TC/HM	Bow shape	Epoxy, Stainless, Metal, Plasterboard, Fiberglass, Limestone	1	B-66450

Joint cutter blade Starlock max shank Multi material

STARLOCK MAX



Range	Makita No.	Blade Width mm	Material of Blade	Material	Sales Pkg Qty	Part No.
★★★☆☆	MAM007	32x70	HCS	Silicon	1	B-66466
	MAM008	32x55	HCS	Silicon, Insulation	1	B-66472

TC segment blade Starlock max shank Grout abrasive

STARLOCK MAX



Range	Makita No.	Blade Width mm	Material of Blade	Note	Material	Sales Pkg Qty	Part No.
★★★☆☆	MAM009	68x10	TC/HM #50	Blade thickness 1.5mm	Grout and mortar remover	1	B-66494
	MAM010		TC/HM #30	Blade thickness 2.2mm		1	B-66503
	MAM013		TC/HM #40	Blade thickness 2.1mm		1	B-66531
	MAM014	100x50		Blade thickness 1.9mm		1	B-66547

Diamond segment blade Starlock max shank Grout abrasive

STARLOCK MAX



Range	Makita No.	Blade Width mm	Material of Blade	Note	Material	Sales Pkg Qty	Part No.
★★★☆☆	MAM011	68x30	Diamond #40	Blade thickness 2.2mm	Grout and mortar remover	1	B-66519
	MAM012	68x10		Blade thickness 1.5mm		1	B-66525

TC sanding plate Starlock max shank Grout abrasive Delta shape

STARLOCK MAX



Range	Makita No.	Blade Width mm	Material of Blade	Note	Material	Sales Pkg Qty	Part No.
★★★☆☆	MAM015	116	TC/HM #20	-	Grout and mortar remover	1	B-66553
	MAM016	116	TC/HM #40			1	B-66569
	MAM017	116	TC/HM #60	Use only wood	Wood	1	B-66575
	MAM018	116	TC/HM #100			1	B-66581

ACCESSORIES

▣ Diamond



Wet



Hook and loop type

Diamond Wheels



Segmented Type:

Most commonly used. Blade has slits and layers of diamond are sintered on edges. Cut faster than continuous rim type and attain average cutting surface.



Segmented Wave Type:

This wheel has slits like segmented wheel. Each segment has many notches (Wave). These notches assure;

- Fast cutting with less resistance.
- Smooth debris removal.
- Less loading on wheel.



Corrugated Type:

This wheel has notches around the Rim. Has a characteristic between Continuous Rim and Segmented Type. Has faster cutting like Segmented Type. At the same time, can attain cleaner surface like continuous rim without broken edges.



Continuous Rim Type:

Has layer of diamond with uniform thickness around the entire rim. Can attain clean surface even on crusty, brittle materials. Cut with accuracy but not as fast as segmented type wheel.

SPECIALIZED



Electrodeposited Type:

Diamonds are electrodeposited and has more exposure than bonded type. Cuts faster and more efficient.



Vacuum brazed Type:

Diamonds are vacuum brazed and has more exposure than bonded type. Able to cut harder material. It is longer life than electrodeposited type because diamonds are held tightly.



Crack Chaser:

Blade is thicker than regular blades. Designed for repair the wall easily.

Material

Material No. 1						
Hard concrete	Granite	Gneiss	Smoothable Engineering	Carbonaceous Shale	Sidewalk Slate	Engineering Block/ Engineering Block Class 2

Material No. 2				Material No. 3		
Concrete	Block	U-shaped Groove	Sidewalk Block	Hard concrete	Cemented Tile	Unglazed Tile

Material No. 4			Material No. 5	Material No. 6	Material No. 7
Brick	Aggregate Block	French Tile	Asphalt	Tile	Glass

Diamond wheel for Angle Grinder with X-lock Concrete Granite Marble Segmented



Range	Work Material	Material No.	Outer dia. mm	Tip height mm	Thread mm	Dry/Wet	Standard	Part No.
★★★★☆	Concrete, Granite, Marble	1 2 3 4	100	7	X-LOCK	Dry	EN13236	E-02054
		1 2 3 4	115	7	X-LOCK	Dry	EN13236	E-02060
		1 2 3 4	125	7	X-LOCK	Dry	EN13236	E-02076

Diamond wheel Concrete Segmented



Range	Work Material	Material No.	Outer dia. mm	Tip height mm	Hole dia. mm	Ring mm(inch)	Dry/Wet	Note	Standard	Sales pkg q'ty	Part No.
★★★★☆		-	125	7.5	22.23	20	Dry	-	-	1	A-02808
		-	180	7.5	22.23	-	Dry	-	-	1	A-02814
		1 2 3 4	125	7	22.23	20	Dry	-	-	1	A-01236
		1 2 3 4 5	125	7.5	20	-	Dry	-	EN13236	1	792282-5
		2 3 4	105	7.5	20	16	Dry	-	-	1	A-87149
		2 3 4	180	6.5	25.4	22.23	Dry	-	-	1	A-87155
		2 3 4	230	7.5	22.23	-	Dry	-	-	1	A-86826
		2 3 4 5	105	7.5	20	16	Dry	-	-	1	A-88842
		2 3 4 5	105	7.3	20	(5/8)	Dry	-	-	1	A-90211
		2 3 4 5	110	6.5	20	-	Dry	-	-	1	A-05022
★★★☆☆	Concrete	2 3 4 5	150	7.5	22.23	-	Dry	-	EN13236	1	B-06432
		2 3 4 5	230	7.5	22.23	-	Dry	-	-	1	A-02820
		-	115	7.5	22.23	-	Dry	-	EN13236	1	D-41589
		-	125	7.5	22.23	-	Dry	-	EN13236	1	D-41595
		-	125	7.5	22.23	-	Dry	-	EN13236	10	D-41595-10
		-	230	7.5	22.23	-	Dry	-	EN13236	1	D-41610
		1 2 3 4	105	7	20	16	Dry	-	-	1	D-42531
		1 2 3 4	115	7	22.23	-	Dry	-	-	1	D-44270
		1 2 3 4	180	7	22.23	-	Dry	-	-	1	D-44286
		1 2 3 4	230	7	22.23	-	Dry	-	-	1	D-44292
		2 3 4	115	7.5	22.23	-	Dry	Long life	-	1	D-37552
		2 3 4	125	7.5	22.23	-	Dry	Long life	-	1	D-37568
		2 3 4 5	105	7	20	16	Dry	-	-	1	D-05197
		2 3 4 5	105	7.64	20	16	Dry	-	EN13236	1	A-84187
		2 3 4 5	115	7.75	22.23	-	Dry	-	EN13236	1	A-84109
		2 3 4 5	125	7.25	22.23	20	Dry	-	EN13236	1	A-84115
		2 3 4 5	180	7.5	25.4	22.23	Dry	-	EN13236	1	A-84121
		2 3 4 5	230	7.5	22.23	-	Dry	-	EN13236	1	A-84137
		2	105	9	20	16	Dry & Wet	-	-	1	D-71009
		2	115	9	22.23	-	Dry	-	-	1	D-71015
2	125	9	22.23	20	Dry & Wet	-	-	1	D-71021		

Diamond wheel Concrete Marble Segmented



Range	Work Material	Outer dia. mm	Tip height mm	Hole dia. mm	Dry/Wet	Standard	Sales pkg q'ty	Part No.
★☆☆☆☆	Concrete, Marble	115	7	22.23	Dry	EN13236	1	D-52750
		125	7	22.23	Dry	EN13236	1	D-52766
		180	7	22.23	Dry	EN13236	1	D-52772
		230	7	22.23	Dry	EN13236	1	D-52788

Diamond wheel Concrete Granite Marble Segmented Ideal for Cordless Angle Grinder



1. Ideal for cordless tools

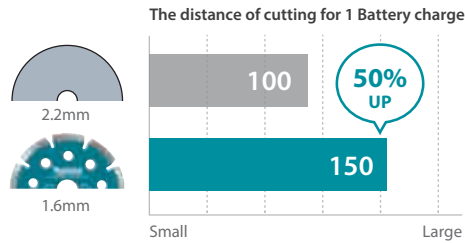

Note:
The test results depend to a great extent on the hardness of materials, etc.
The numbers in the bar graphs are relative values when the capacity of Makita Diamond Wheel (Thickness:2.2mm) is indexed at 100.

2. Thin blade & Light weight



This blade is designed as 1.6mm (the basis is 1.1mm). So smooth and light cutting is available.

It was lightened by punching the body. (eg:ø125mm blade is 95g [current blade : 125g])

It is also reduced the load on the battery and increased the cutting distance per 1 battery charge.

Range	Work Material	Material No.	Outer dia. mm	Tip height mm	Hole dia. mm	Dry/Wet	Standard	Sales pkg q'ty	Part No.
★★★★☆	Concrete, Granite, Marble	1 2 3 4	115	7	22.23	Dry	EN13236	1	B-53780
		1 2 3 4	125	7	22.23	Dry	EN13236	1	B-53796

Diamond wheel Concrete Corrugated



Range	Work Material	Material No.	Outer dia. mm	Tip height mm	Hole dia. mm	Ring mm	Dry/Wet	Note	Standard	Sales pkg q'ty	Part No.
★★★★☆		1 2 3 4 5	110	10	20	16	Dry	-	-	1	B-39207
		1 2 3 4 5 6	110	5	20	-	Wet	-	-	1	B-02836
		1 2 3 4 5 6	110	5	20	-	Wet	-	EN13236	1	B-22034
★★★☆☆	Concrete	-	115	7.5	22.23	-	Dry	-	EN13236	1	D-41626
		-	125	7.5	22.23	-	Dry	-	EN13236	1	D-41632
		-	180	7.5	22.23	-	Dry	-	EN13236	1	D-41648
		-	230	7.5	22.23	-	Dry	-	EN13236	1	D-41654
		2 3 4	105	8	20	16	Dry	-	-	1	D-05206
		2 3 4	115	7.5	22.23	-	Dry	Long life	-	1	D-37596
		2 3 4	125	7.5	22.23	-	Dry	Long life	-	1	D-37605
		2 3 4	180	7.5	22.23	-	Dry	Long life	-	1	D-37611
		2 3 4	230	7.5	22.23	-	Dry	Long life	-	1	D-37627
		2 3 4 5	105	7.25	20	16	Dry	-	EN13236	1	A-84193
		2 3 4 5	115	7.25	22.23	-	Dry	-	EN13236	1	A-84143
		2 3 4 5	125	7.15	22.23	20	Dry	-	EN13236	1	A-84159
		2 3 4 5	180	7.5	25.4	22.23	Dry	-	EN13236	1	A-84165
		2 3 4 5	230	7.5	22.23	-	Dry	-	EN13236	1	A-84171
		★★★★☆		2 3 4	110	7	20	16	Dry	-	-
2 3 4	110			10	20	16	Dry	-	-	1	D-42640

Diamond wheel Concrete Marble Corrugated



Range	Work Material	Outer dia. mm	Tip height mm	Hole dia. mm	Dry/Wet	Standard	Sales pkg q'ty	Part No.
★★★★☆	Concrete, Marble	115	7	22.23	Dry	EN13236	1	D-52794
		125	7	22.23	Dry	EN13236	1	D-52803
		180	7	22.23	Dry	EN13236	1	D-52819
		230	7	22.23	Dry	EN13236	1	D-52825

Diamond wheel Concrete Tile Corrugated



Range	Work Material	Material No.	Outer dia. mm	Tip height mm	Hole dia. mm	Ring mm	Dry/Wet	Standard	Sales pkg q'ty	Part No.
★★★★☆	Concrete, Roof tile	1 2 3 4 5	115	7.6	22.23	-	Dry	EN13236	1	A-80684
		1 2 3 4 5	125	7.8	22.23	20	Dry	-	1	A-02761
		1 2 3 4 5	125	7.8	22.23	-	Dry	EN13236	1	A-80690
		1 2 3 4 5	180	7.95	22.23	-	Dry	-	1	A-80709
		-	180	7.95	22.23	-	Dry	-	1	A-02777
		1 2 3 4 5	230	8.55	22.23	-	Dry	EN13236	1	A-80715

Diamond wheel Concrete Granite Corrugated



Range	Work Material	Material No.	Outer dia. mm	Tip height mm	Hole dia. mm	Ring mm	Dry/Wet	Standard	Sales pkg q'ty	Part No.
★★★★☆	Concrete,	1 2 3 4 5 6	125	7.5	20	-	Wet	EN13236	1	B-16748
★★★★☆	Granite	1 2 3 4	110	10	20	16	Dry	-	1	D-42628

Diamond wheel Concrete Granite Segmented wave



Range	Work Material	Material No.	Outer dia. mm	Tip height mm	Hole dia. mm	Ring mm	Dry/Wet	Sales pkg q'ty	Part No.
★★★★☆	Concrete, Granite	1 2 3 4	105	7	20	16	Dry	1	D-42581
		1 2 3 4	115	7	22.23	-	Dry	1	D-41420
		1 2 3 4	180	7	22.23	-	Dry	1	D-44339
		1 2 3 4	230	7	22.23	-	Dry	1	D-44345

Diamond wheel Concrete Marble Continuous rim



Range	Work Material	Material No.	Outer dia. mm	Tip height mm	Hole dia. mm	Dry/Wet	Sales pkg q'ty	Part No.
★★★★☆	Concrete, Marble	2 3 4 6	110	5	20	Wet	1	D-05212

Diamond wheel Concrete Continuous rim



Range	Work Material	Material No.	Outer dia. mm	Tip height mm	Hole dia. mm	Dry/Wet	Standard	Sales pkg q'ty	Part No.
★★★★☆	Concrete	1 2 3 4 5 6	110	4	20	Wet	-	1	A-07185
		1 2 3 4 5 6	110	4	20	Wet	-	1	A-81131
		1 2 3 6	110	4	20	Wet	-	1	A-85210
		1 2 3 4 6	110	4	20	Wet	-	1	A-01292
		1 2 3 4 6	125	5.5	20	Wet	EN13236	1	B-21951
		1 2 3 4 5 6	180	4	25	Wet	-	1	792191-8
		1 2 3 4 5 6	180	4	25	Wet	-	1	A-80117
		-	180	5	25.4	Wet	-	1	A-87161

Diamond wheel Concrete Segmented wave



Range	Work Material	Material No.	Outer dia. mm	Tip height mm	Hole dia. mm	Ring mm	Dry/Wet	Standard	Sales pkg q'ty	Part No.
★★★★☆	Concrete	1 2 3 4 5	115	7.5	22.23	-	Dry	-	1	B-02048
		2 3 4 5	105	7.5	20	16	Dry	-	1	B-03028
		2 3 4 5	115	7.5	22.23	-	Dry	-	1	A-80422
		1 2 3 4 5	125	7.5	22.23	-	Dry	-	1	B-02054
		2 3 4 5	125	7.5	22.23	-	Dry	EN13236	1	A-80438
		1 2 3 4 5	180	8	22.23	-	Dry	-	1	B-02060
		2 3 4 5	180	7.5	22.23	-	Dry	-	1	A-83842
		1 2 3 4 5	230	7.5	22.23	-	Dry	-	1	B-02004
		2 3 4	230	7.5	22.23	-	Dry	EN13236	1	A-80173

Diamond wheel Brick Segmented

Range	Work Material	Outer dia. mm	Tip height mm	Hole dia. mm	Ring mm	Dry/Wet	Sales pkg q'ty	Part No.
★★★★☆	Brick	125	7.5	22.23	20	Dry	1	A-02200
		230	6.5	22.23	-	Dry	1	A-02216

Diamond wheel Granite Segmented



Range	Work Material	Material No.	Outer dia. mm	Tip height mm	Hole dia. mm	Ring mm	Dry/Wet	Sales pkg q'ty	Part No.
★★★★☆	Granite	1 2 3 4 5	105	7.5	20	16	Dry	1	A-84090
		1 2 3 4 5	115	7.5	22.23	-	Dry	1	A-84006
		-	125	7.5	22.23	20	Dry	1	A-07381
		1 2 3 4 5	125	7.5	22.23	20	Dry	1	A-84012
		1 2 3 4 5	180	6	25.4	22.23	Dry	1	A-84028
		1 2 3 4 5	230	7	22.23	-	Dry	1	A-84408
★★★☆☆		1 2 3 4	105	7	20	16	Dry	1	D-42656
★★★★☆		-	105	10	20	16	Wet	1	D-41399
		1 2 3 4	105	10	20	16	Wet	1	D-44351

Diamond wheel Marble Segmented



Range	Work Material	Material No.	Outer dia. mm	Tip height mm	Hole dia. mm	Ring mm	Dry/Wet	Sales pkg q'ty	Part No.
★★★★☆	Marble	-	105	10	20	16	Wet	1	D-41408
	Marble	1 2 3 4	105	10	20	16	Wet	1	D-44367

Diamond wheel Granite Marble Segmented



Range	Work Material	Material No.	Outer dia. mm	Tip height mm	Hole dia. mm	Ring mm	Dry/Wet	Sales pkg q'ty	Part No.
★★★★☆	Granite, Marble	-	105	8	20	16	Dry & Wet	1	D-67511
		1 2 3 4	105	8	20	16	Dry & Wet	1	D-63688

Diamond wheel Granite Corrugated



Range	Work Material	Material No.	Outer dia. mm	Tip height mm	Hole dia. mm	Ring mm	Dry/Wet	Standard	Sales pkg q'ty	Part No.
★★★★☆	Granite	1 2 3 4 5	105	7.25	20	16	Dry	EN13236	1	A-84040
		1 2 3 4 5	110	8	20	16	Dry	-	1	D-42662
		1 2 3 4 5	115	7.25	22.23	-	Dry	EN13236	1	A-84056
		1 2 3 4 5	125	7.15	22.23	20	Dry	EN13236	1	A-84062
		1 2 3 4 5	180	7.5	25.4	22.23	Dry	EN13236	1	A-84078
		1 2 3 4 5	230	7.5	22.23	-	Dry	EN13236	1	A-84084

Diamond wheel Granite Marble Corrugated



Range	Work Material	Material No.	Outer dia. mm	Tip height mm	Hole dia. mm	Ring mm	Dry/Wet	Sales pkg q'ty	Part No.
★★★★☆	Granite, Marble	1 2 3 4	105	7	20	16	Dry	1	D-42553
		1 2 3 4	115	7	22.23	-	Dry	1	D-44301
		1 2 3 4	180	7	22.23	-	Dry	1	D-44317
		1 2 3 4	230	7	22.23	-	Dry	1	D-44323

Diamond wheel Marble Continuous rim



Range	Work Material	Outer dia. mm	Tip height mm	Hole dia. mm	Dry/Wet	Sales pkg q'ty	Part No.
★★★★☆	Marble	115	5	22.23	Dry	1	D-36837

Diamond wheel Tile Corrugated Ideal for Cordless Angle Grinder



1. Ideal for cordless tools

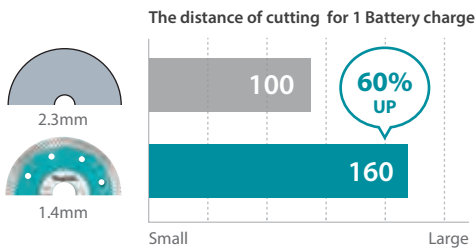

Note:
The test results depend to a great extent on the hardness of materials, etc.
The numbers in the bar graphs are relative values when the capacity of Makita Diamond Wheel (Thickness:2.3mm) is indexed at 100.

2. Thinner blade

With the bare necessities of thickness which able to have enough strength, able to get smooth and light cutting.

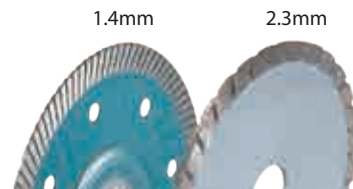

Range	Work Material	Material No.	Outer dia. mm	Tip height mm	Hole dia. mm	Ring mm	Dry/Wet	Standard	Sales pkg q'ty	Part No.
★★★★☆	Porcelain tile	2 3 4 6	105	10	22.23	16	Dry	EN13236	1	B-49030
		2 3 4 6	115	10	22.23	-	Dry	EN13236	1	B-46327
		2 3 4 6	125	10	22.23	-	Dry	EN13236	1	B-46333

Diamond wheel Tile Corrugated



Range	Work Material	Material No.	Outer dia. mm	Tip height mm	Hole dia. mm	Ring mm	Dry/Wet	Sales pkg q'ty	Part No.
★★★★☆	Porcelain tile	2 3 4 6	110	8	20	-	Dry	1	D-51057
		2 3 4 6	115	8	22.23	-	Dry	1	D-50893
		2 3 4 6	180	8	22.23	-	Dry	1	D-50902
★★★★☆	Porcelain tile, Ceramic tile	-	105	10	20	16	Dry & Wet	1	D-77198

Diamond wheel Tile Continuous rim



Range	Work Material	Material No.	Outer dia. mm	Tip height mm	Hole dia. mm	Ring mm	Dry/Wet	Note	Standard	Sales pkg q'ty	Part No.
★★★★☆	Porcelain tile	-	105	7	20	16	Dry & Wet	Continuous rim with slit	EN13236	1	D-76299
		6	115	7	22.23	-	Dry		-	1	D-65109
★★★★☆	Ceramic Tile	2 3 4 6	110	5	20	16	Wet	-	-	1	D-44258
		2 3 4 6	180	5	25.4	-	Wet	-	-	1	D-44264
	Porcelain tile	-	110	5	22.23	-	Dry	-	EN13236	1	D-52716

Diamond wheel Glass Corrugated



Range	Work Material	Material No.	Outer dia. mm	Tip height mm	Hole dia. mm	Dry/Wet	Standard	Sales pkg q'ty	Part No.
★★★★☆	Bulletproof Glass	3 4 5 6 7	110	5.75	20	Wet	-	1	B-00795
		3 4 5 6 7	110	5.75	20	Wet	EN13236	1	B-22028

Diamond wheel Glass Continuous rim



Range	Work Material	Material No.	Outer dia. mm	Tip height mm	Hole dia. mm	Dry/Wet	Sales pkg q'ty	Part No.
★★★★☆	Glass	7	110	5.2	20	Wet	1	D-40705

Diamond wheel Marmoglass Continuous rim



Range	Work Material	Material No.	Outer dia. mm	Tip height mm	Hole dia. mm	Dry/Wet	Sales pkg q'ty	Part No.
★★★★☆	Marmoglass	6	110	8.5	20	Wet	1	D-37770

Diamond wheel Mortar Corrugated



Range	Work Material	Material No.	Outer dia. mm	Tip height mm	Hole dia. mm	Ring mm	Dry/Wet	Sales pkg q'ty	Part No.
★★★★☆	Mortar	2 3 4 5	115	7.6	22.23	-	Dry	1	B-02967
		2 3 4 5	125	7.8	22.23	20	Dry	1	B-02973
		2 3 4 5	180	7.95	22.23	-	Dry	1	B-02989
		2 3 4 5	230	8.3	22.23	-	Dry	1	B-01806

Diamond wheel Universal Corrugated



Range	Work Material	Outer dia. mm	Tip height mm	Hole dia. mm	Dry/Wet	Standard	Sales pkg q'ty	Part No.
Specialized	Concrete, Granite, Marble, Porcelain tile	125	8	20	Dry & Wet	EN13236	1	D-72899

Diamond wheel Universal Segmented



Range	Work Material	Outer dia. mm	Tip height mm	Hole dia. mm	Ring mm	Dry/Wet	Standard	Sales pkg q'ty	Part No.
★★★★☆	Concrete, Brick, Limestone, Roof tile	105	12	20	16	Dry & Wet	EN13236	1	D-74083
		115	12	22.23	-	Dry	EN13236	1	D-74099
		125	12	22.23	20	Dry & Wet	EN13236	1	D-74108
		180	12	25.4	22.23	Dry & Wet	EN13236	1	D-74114
		230	12	22.23	-	Dry & Wet	EN13236	1	D-74120

Diamond wheel Tuck Point Mortar



Range	Work Material	Outer dia. mm	Tip height mm	Hole dia. mm	Dry/Wet	Sales pkg q'ty	Part No.
★★★★☆	Mortar	125	8	22.23	Dry	1	A-02705

Curved Diamond wheel Marble Corrugated



Range	Work Material	Material No.	Outer dia. mm	Tip height mm	Hole dia. mm	Dry/Wet	Sales pkg q'ty	Part No.
★★☆☆☆	Marble	2 3 4	110	8	20	Dry	1	D-36968

Electroplated Diamond wheel Marble



Fine Surface

Cutting surface is very fine for the additional diamond on the plate's side.



DRY Cutting and Smoothly Cutting

Thanks to high-quality diamond, it can be used for dry cutting despite rim type. So smooth and fine cutting of marble is available.



< Comparison of cutting surface >

Electroplated type



Fine

Normal



Normal

Range	Work Material	Material No.	Outer dia. mm	Tip height mm	Hole dia. mm	Dry/Wet	Sales pkg q'ty	Part No.
★★★★☆	Marble	-	110	3	20	Wet	1	D-38277
		3	115	5	22.23	Dry	1	D-51085
		3	180	5	22.23	Dry	1	D-51091
		3	230	5	22.23	Dry	1	D-51100
		3	110	5	20	Wet	1	D-45004

Vacuum brazed Diamond wheel Metal Segmented



Range	Work Material	Outer dia. mm	Tip height mm	Hole dia. mm	Dry/Wet	Standard	Sales pkg q'ty	Part No.
Specialized	Metal	100	1.8	16	Dry	EN13236	1	B-53671
		115	1.8	22.23	Dry	EN13236	1	B-53687
		125	1.8	22.23	Dry	EN13236	1	B-53693
		180	1.8	22.23	Dry	EN13236	1	B-53702
		230	1.8	22.23	Dry	EN13236	1	B-53718

Vacuum brazed Diamond wheel Multi material Segmented

1. Cut various material



The diamond abrasive grain are adhered on wheel surface directly which is different from the regular wheel containing diamond abrasive grain buried on layers.

2. Less spark

Diamond wheel



Abrasive Cut-off wheel



The major general contractor dislike sparks at the work site, so you can recommend this blade to these work site.

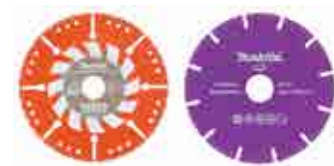

Range	Work Material	Material No.	Outer dia. mm	Tip height mm	Hole dia. mm	Ring mm	Dry/Wet	Note	Standard	Sales pkg q'ty	Part No.
Specialized	Metal, Plastic, Reinforced concrete	1 2 3 4	110	5	20	16	Dry	-	-	1	D-44426
		-	115	5	22.23	-	Dry	-	-	1	D-58883
		-	180	5	22.23	-	Dry	-	-	1	D-58899
		-	230	5	22.23	-	Dry	-	-	1	D-58908
	Metal, Plastic, Wood, Glass, Brick, Fiber cement board, concrete	1 2 3 4 5 6 7	100	3	16	-	Dry	for Rescue	EN13236	1	B-66933
		1 2 3 4 5 6 7	115	3	22.23	-	Dry	for Rescue	EN13236	1	B-55304
		1 2 3 4 5 6 7	125	3	22.23	-	Dry	for Rescue	EN13236	1	B-55310
		1 2 3 4 5 6 7	180	3	22.23	-	Dry	for Rescue	EN13236	1	B-66949
		1 2 3 4 5 6 7	230	3	22.23	-	Dry	for Rescue	EN13236	1	B-55326

Diamond wheel for Cordless Compact Cut-off Tile Continuous rim



Range	Work Material	Outer dia. mm(inch)	Tip height mm	Hole dia. mm(inch)	Dry/Wet	Standard	Sales pkg q'ty	Part No.
★★★★☆	Porcelain tile	76(3)	8	9.5(3/8)	Dry & Wet	EN13236	1	D-75580
		76	8	10	Dry & Wet	EN13236	1	D-74790

Diamond wheel for 4103KB Concrete Continuous rim

Range	Work Material	Material No.	Outer dia. mm	Tip height mm	Hole dia. mm	Dry/Wet	Standard	For model	Sales pkg q'ty	Part No.
★★★★☆	Concrete	1 2 3 4 6	80	3.5	20	Dry	-	4103KB	1	792192-6
		1 2 3 4 6	80	3.5	20	Dry	EN13236	4103KB	1	B-22012

Diamond wheel for 4103KB Granite Continuous rim



Range	Work Material	Material No.	Outer dia. mm	Tip height mm	Hole dia. mm	Dry/Wet	For model	Sales pkg q'ty	Part No.
★★★★☆	Granite	1 2 3 4 6	80	5	20	Dry	4103KB	1	A-01264

Diamond wheel for Angle Cutter Concrete Segmented



Range	Work Material	Material No.	Outer dia. mm	Tip height mm	Hole dia. mm	Ring mm	Dry/Wet	Sales pkg q'ty	Part No.
★★★★☆	Concrete	2 3 4 5	305	7.5	30	20,22,23,25.4	Dry	1	A-02478

Diamond wheel for Angle Cutter Asphalt Concrete Segmented



Range	Work Material	Material No.	Outer dia. mm	Tip height mm	Hole dia. mm	Ring mm	Dry/Wet	Sales pkg q'ty	Part No.
★★★★☆	Asphalt, Concrete	2 3 4 5	305	7.5	30	20,22,23,25.4	Dry	1	A-02490

Diamond wheel for Angle Cutter Granite Segmented



Range	Work Material	Material No.	Outer dia. mm	Tip height mm	Hole dia. mm	Dry/Wet	Sales pkg q'ty	Part No.
★★★★☆	Granite	1 2 3 4 5	255	7	25.4	Dry	1	A-02406

Diamond wheel for Angle Cutter Asphalt Segmented



Range	Work Material	Material No.	Outer dia. mm	Tip height mm	Hole dia. mm	Ring mm	Dry/Wet	Sales pkg q'ty	Part No.
★★★★☆	Asphalt	5	305	7.5	30	20,22,23,25.4	Dry	1	A-02484

Diamond wheel for Cordless Cutter Glass Continuous rim



Range	Work Material	Material No.	Outer dia. mm	Tip height mm	Hole dia. mm	Dry/Wet	Sales pkg q'ty	Part No.
★★★★☆	Glass	6 7	80	4	15	Wet	1	792296-4

Diamond wheel for Cordless Cutter Glass Corrugated



Range	Work Material	Material No.	Outer dia. mm	Tip height mm	Hole dia. mm	Dry/Wet	Sales pkg q'ty	Part No.
★★★★☆	Glass	3 4 5 6 7	85	5	15	Dry	1	B-02995

Diamond wheel for Cordless Cutter Glass Tile Continuous rim



Range	Work Material	Material No.	Outer dia. mm	Tip height mm	Hole dia. mm	Dry/Wet	Standard	Sales pkg q'ty	Part No.
★★★★☆	Glass, Tile	6 7	85	5.5	15	Wet	-	1	B-21082
		6 7	85	5	15	Wet	EN13236	1	B-21098

Electroplated Diamond wheel for Cordless Cutter Glass Tile



Range	Work Material	Material No.	Outer dia. mm	Tip height mm	Hole dia. mm	Dry/Wet	Sales pkg q'ty	Part No.
★★★★☆	Glass, Porcelain tile	3 6 7	85	1.2	15	Wet	1	A-07179

Diamond wheel for Power cutter Concrete Segmented



Range	Work Material	Material No.	Outer dia. mm	Tip height mm	Hole dia. mm	Ring mm	Dry/Wet	Note	Standard	Sales pkg q'ty	Part No.
★★★★☆	Concrete	1 2 3 4	300	7	25.4	20	Dry	-	-	1	A-86773
		1 2 3 4	304	8	25.4	20	Dry	-	-	1	A-89349
		1 2 3 4	350	7	25.4	20	Dry	-	-	1	A-87317
		1 2 3 4 5	305	8.5	25.4	20	Dry	-	-	1	A-87018
★★★☆☆	Concrete	-	300	7.5	25.4	20	Dry	Laser welded	EN13236	1	D-56982
		-	350	7.5	25.4	20	Dry	Laser welded	EN13236	1	D-56998
		-	400	7.5	25.4	20	Dry	Laser welded	EN13236	1	D-57009

Diamond wheel for Power cutter Concrete Segmented Ideal for Cordless Power Cutter



Range	Work Material	Material No.	Outer dia. mm	Tip height mm	Hole dia. mm	Dry/Wet	Note	Standard	Sales pkg q'ty	Part No.
★★★★☆	Concrete	-	355	10	25.4	Dry & Wet	-	EN13236	1	E-12996
		1 2 3 4	230	13+2	22.23	Dry & Wet	Grit patterned	EN13236	1	E-02967

Vacuum brazed Diamond wheel for Power cutter Multi material Segmented



Range	Work Material	Material No.	Outer dia. mm	Tip height mm	Hole dia. mm	Dry/Wet	Note	Standard	Sales pkg q'ty	Part No.
Specialized	Metal, Plastic, Wood, Glass, Brick, Fiber cement board, concrete	1 2 3 4 5 6 7	305	3	25.4	Dry	for Rescue	EN13236	1	B-55332
		1 2 3 4 5 6 7	355	3	25.4	Dry	for Rescue	EN13236	1	B-55348
		1 2 3 4 5 6 7	405	3	25.4	Dry	for Rescue	EN13236	1	B-66955

Vacuum brazed Diamond wheel for Portable Cut-off Metal Segmented



Range	Work Material	Outer dia. mm	Tip height mm	Hole dia. mm	Dry/Wet	Sales pkg q'ty	Part No.
★★★★☆	Metal	355	3.5	25.4	Dry	1	B-29511
★★★★☆		355	3	25.4	Dry	1	D-41414

Diamond wheel for Tile saw Tile Continuous rim



Range	Work Material	Outer dia. mm	Tip height mm	Hole dia. mm	Ring mm	Dry/Wet	Standard	Sales pkg q'ty	Part No.
★☆☆☆☆	Porcelain tile	180	5	25.4	-	Wet	EN13236	1	D-52722
		200	5	25.4	-	Wet	EN13236	1	D-52738
		250	7	30	25.4	Wet	EN13236	1	D-52744

Diamond wheel for Wall Chaser Concrete





Range	Work Material	Material No.	Outer dia. mm	Tip height mm	Hole dia. mm	Dry/Wet	Sales pkg q'ty	Part No.
★★★★☆	Concrete	2 3 4 5	155	7	22.23	Dry	1	A-83836

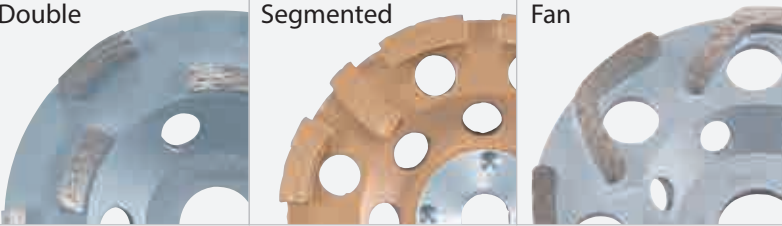
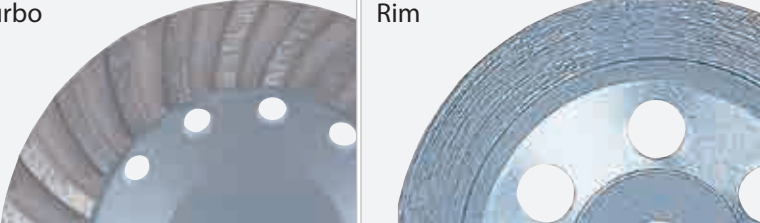

Offset Diamond Wheels

<p>Single</p> 	<p>Rough work This wheel grind more efficiency. Faster than the wheel for standard work.</p>
<p>Double Segmented Fan</p> 	<p>Standard work This wheel has a characteristic between Rough work offset diamond wheels and Fine work offset diamond wheels.</p>
<p>Turbo Rim</p> 	<p>Fine work This wheel is suitable for cleanup and finish work and chamfering works.</p>

SPECIALIZED

<p>PCD</p> 	<p>Removal of paint This wheel is suitable for removal of polyurethane, adhesive, paint, epoxy and acrylic coating. PCD is an abbreviations of "Polycrystalline Diamond". It is a kind of an artificial diamond and superior in hardness and durability.</p>
<p>Vacuum brazed</p> 	<p>For hard materials This wheel is suitable for hard materials. Diamonds are held tightly.</p>

Low Vibration Offset Diamond Wheel

	<p>Low Vibration The vibration is not conducted to the worker's hand and able to ease the load a lot!!</p> <p>Less Tapping Clinging to the material and able to cut smoothly, faster and more efficient.</p> <p>Low Vibration Type</p> <p>Normal  → Low Vibration Type </p>
-------------------------------------------------------------------------------------	-----------------------------------------------------------------------------------------------------------------------------------------------------------------------------------------------------------------------------------------------------------------------------------------------------------------------------------------------------------------------------------------------------------------------------------------------------------------------------------------

Offset Diamond wheel Single Low vibration



Range	Work Material	Material No.	Outer dia. mm	Tip height mm	Thread mm	Dry/Wet	Note	Standard	Sales pkg q'ty	Part No.
★★★★☆	Concrete	1 2 3 4 5	125	5.5	M14	Dry	Rough work	EN13236	1	B-48533
		1 2 3 4 5	180	5	M14	Dry	Rough work	EN13236	1	B-48599

Offset Diamond wheel Double Low vibration



Range	Work Material	Material No.	Outer dia. mm	Tip height mm	Thread mm	Dry/Wet	Note	Standard	Sales pkg q'ty	Part No.
★★★★☆	Concrete	1 2 3 4 5	125	5.5	M14	Dry	Standard work	EN13236	1	B-48549
		1 2 3 4 5	180	5	M14	Dry	Standard work	EN13236	1	B-48608

Offset Diamond wheel Fan Low vibration



Range	Work Material	Material No.	Outer dia. mm	Tip height mm	Thread mm	Dry/Wet	Note	Standard	Sales pkg q'ty	Part No.
★★★★☆	Concrete	1 2 3 4 5	125	5	M14	Dry	Standard work	EN13236	1	B-48555
		1 2 3 4 5	180	5	M14	Dry	Standard work	EN13236	1	B-48614

Offset Diamond wheel Turbo Low vibration



Range	Work Material	Material No.	Outer dia. mm	Tip height mm	Thread mm	Dry/Wet	Note	Standard	Sales pkg q'ty	Part No.
★★★★☆	Concrete	1 2 3 4 5	125	4.5	M14	Dry	Fine work	EN13236	1	B-49993
		1 2 3 4 5	180	5	M14	Dry	Fine work	EN13236	1	B-48620

Offset Diamond wheel Single



Range	Work Material	Material No.	Outer dia. mm	Tip height mm	Hole dia. mm	Ring mm	Dry/Wet	Note	Standard	Sales pkg q'ty	Part No.
★★★★☆	Concrete	1 2 3 4 5	105	4	22.23	-	Dry	Rough work	-	1	B-14629
		1 2 3 4 5	125	5.5	22.23	-	Dry	Rough work	EN13236	1	B-48561
		1 2 3 4 5	180	5	22.23	-	Dry	Rough work	EN13236	1	B-48636
★☆☆☆☆	Concrete	1 2 3 4 5	100	5	22.23	16	Dry	Rough work	EN13236	1	D-62284
		1 2 3 4 5	115	5	22.23	-	Dry	Rough work	EN13236	1	D-60676
		1 2 3 4 5	125	5	22.23	-	Dry	Rough work	EN13236	1	D-60682
		1 2 3 4 5	180	5	22.23	-	Dry	Rough work	EN13236	1	D-62290

Offset Diamond wheel Double

Medium
WORK



Range	Work Material	Material No.	Outer dia. mm	Tip height mm	Hole dia. mm	Ring mm	Dry/Wet	Note	Standard	Sales pkg q'ty	Part No.
★★★★☆	Concrete	1 2 3 4 5	125	4.5	22.23	-	Dry	Standard work	EN13236	1	B-12295
		1 2 3 4 5	125	5.5	22.23	-	Dry	Standard work	EN13236	1	B-48577
		1 2 3 4 5	180	5	22.23	-	Dry	Standard work	EN13236	1	B-48642
★☆☆☆☆		1 2 3 4 5	100	5	22.23	16	Dry	Standard work	EN13236	1	D-62309
		1 2 3 4 5	115	5	22.23	-	Dry	Standard work	EN13236	1	D-62315
		1 2 3 4 5	125	5	22.23	-	Dry	Standard work	EN13236	1	D-66715
		1 2 3 4 5	180	5	22.23	-	Dry	Standard work	EN13236	1	D-62321

Offset Diamond wheel Segmented

Medium
WORK



Range	Work Material	Material No.	Outer dia. mm	Tip height mm	Hole dia. mm	Dry/Wet	Note	Standard	Sales pkg q'ty	Part No.
★★★★☆	Concrete	1 2 3 4 5	100	5	22.23	Dry	Standard work	EN13236	1	A-87105

Offset Diamond wheel Fan

Medium
WORK



Range	Work Material	Material No.	Outer dia. mm	Tip height mm	Hole dia. mm	Dry/Wet	Note	Standard	Sales pkg q'ty	Part No.
★★★★☆	Concrete	1 2 3 4 5	125	5	22.23	Dry	Standard work	EN13236	1	B-48583
		1 2 3 4 5	180	5	22.23	Dry	Standard work	EN13236	1	B-48658

Offset Diamond wheel Turbo

Fine
WORK



Range	Work Material	Material No.	Outer dia. mm	Tip height mm	Hole dia. mm	Ring mm	Dry/Wet	Note	Standard	Sales pkg q'ty	Part No.
★★★★☆	Concrete	1 2 3 4 5	105	5	22.23	-	Dry	Fine work	-	1	B-44993
		1 2 3 4 5	125	4.5	22.23	-	Dry	Fine work	EN13236	1	B-50005
		1 2 3 4 5	180	5	22.23	-	Dry	Fine work	EN13236	1	B-48664
★☆☆☆☆		1 2 3 4 5	100	5	22.23	16	Dry	Fine work	EN13236	1	D-62337
		1 2 3 4 5	115	5	22.23	-	Dry	Fine work	EN13236	1	D-62343
		1 2 3 4 5	125	5	22.23	-	Dry	Fine work	EN13236	1	D-66721
		1 2 3 4 5	180	5	22.23	-	Dry	Fine work	EN13236	1	D-62359

Offset Diamond wheel Rim

Fine
WORK



Range	Work Material	Material No.	Outer dia. mm	Tip height mm	Hole dia. mm	Dry/Wet	Note	Standard	Sales pkg q'ty	Part No.
★★★★☆	Concrete	1 2 3 4 5	125	4	22.23	Dry	Fine work	EN13236	1	B-12289

Offset Diamond wheel for PC1100 Segmented



Range	Work Material	Material No.	Outer dia. mm	Tip height mm	Hole dia. mm	Dry/Wet	Note	Standard	For model	Sales pkg q'ty	Part No.
★★★☆☆	Concrete	1 2 3 4 5	110	5	15	Dry	Standard work	EN13236	PC1100	1	A-86321

Offset Diamond wheel for PC1100 Turbo



Range	Work Material	Material No.	Outer dia. mm	Tip height mm	Hole dia. mm	Dry/Wet	Note	Standard	For model	Sales pkg q'ty	Part No.
★★★☆☆	Concrete	1 2 3 4 5	110	4	15	Dry	Fine work	EN13236	PC1100	1	A-07369

Offset Diamond wheel for PC1100 Rim



Range	Work Material	Material No.	Outer dia. mm	Tip height mm	Hole dia. mm	Dry/Wet	Note	Standard	For model	Sales pkg q'ty	Part No.
★★★☆☆	Concrete	1 2 3 4 5	110	4	15	Dry	Fine work	EN13236	PC1100	1	792289-1

Offset Diamond wheel for Concrete Planer Double



Range	Work Material	Material No.	Outer dia. mm	Tip height mm	Hole dia. mm	Dry/Wet	Note	Standard	Sales pkg q'ty	Part No.
★★★☆☆	Concrete	1 2 3 4 5	125	5	22.23	Dry	Standard work	EN13236	1	D-41458

Offset Diamond wheel for Concrete Planer Rim



Range	Work Material	Material No.	Outer dia. mm	Tip height mm	Hole dia. mm	Dry/Wet	Note	Standard	Sales pkg q'ty	Part No.
★★★☆☆	Concrete	1 2 3 4 5	125	4	22.23	Dry	Fine work	EN13236	1	D-41464

Offset Diamond wheel for PK5001C Turbo



Range	Work Material	Outer dia. mm	Tip height mm	Thread mm	Dry/Wet	For model	Sales pkg q'ty	Part No.
★★★☆☆	Granite, Marble	125	5	M14	Wet	PK5001C/PK5011C	1	D-36843

Offset Diamond wheel for PK5001C Rim



Range	Work Material	Outer dia. mm	Tip height mm	Thread mm	Dry/Wet	Note	For model	Sales pkg q'ty	Part No.
★★★★☆	Granite, Marble	100	3.5	M14	Wet	Grit 36	PK5001C/ PK5011C	1	D-37247
		100	3.5	M14	Wet	Grit 60	PK5001C/ PK5011C	1	D-37253
		100	3.5	M14	Wet	Grit 120	PK5001C/ PK5011C	1	D-37269
		100	3.5	M14	Wet	Grit 220	PK5001C/ PK5011C	1	D-37275
		100	3.5	M14	Wet	Grit 400	PK5001C/ PK5011C	1	D-37281

PCD Offset Diamond wheel



This Offset Diamond Wheel can be used for removing of polyurethane, adhesive, paint, epoxy and acrylic coatings.



< Difference with the normal offset diamond >

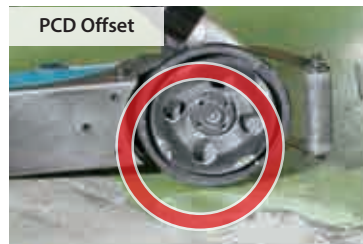

It just scratched the surface and couldn't remove the paint film.

Range	Work Material	Outer dia. mm	Tip height mm	Hole dia. mm	Dry/Wet	Standard	Sales pkg q'ty	Part No.
Specialized	Polyurethane, Adhesive, Paint, Epoxy, Acrylic coatings	125	2.6	22.23	Dry	EN13236	1	B-53160
		180	2.6	22.23	Dry	EN13236	1	B-53176

Vacuum brazed Offset Diamond wheel



Range	Work Material	Material No.	Outer dia. mm	Tip height mm	Hole dia. mm	Dry/Wet	Note	Sales pkg q'ty	Part No.
★★★★☆	Concrete, Granite	1 2 3	115	0.7	22.23	Dry	Standard work	1	A-87834
		1 2 3	115	0.7	22.23	Dry	Standard work	1	A-87884

Diamond core bit for SDS-PLUS hammers



Cutting depth: 175mm

Range	Outer dia. mm	Dry/Wet	Part No.
★★★★☆	38	Dry	A-87535
	54	Dry	A-87541
	65	Dry	A-87557

Diamond core bit for SDS-PLUS hammers adapter



Range	Shank mm	Part No.
★★★★☆	SDS-PLUS	A-87563

Diamond core bit for Diamond Core Hammer Drill



Cutting depth: 165mm

Range	Outer dia. mm	Dry/Wet	Part No.
★★★★☆	32	Dry	A-85036
	38	Dry	A-85042
	54	Dry	A-85058
	65	Dry	A-85064
	70	Dry	A-85070
	80	Dry	A-80472
	90	Dry	A-85086
	105	Dry	A-80488
	120	Dry	A-80494
	127	Dry	A-85606
	152	Dry	A-85597
	162	Dry	A-85612

Diamond core bit for Diamond Core Hammer Drill center bit



Range	Part No.
★★★★☆	A-80503

Diamond core bit for Diamond Core Hammer Drill adapter



Range	Shank mm	Part No.
★★★★☆	13mm Hex	A-80519

Diamond Core Drill Bit for Grinders		
	Vacuum brazed	Electroplated
Fix	Special chemical bond	Nickel plating
Fixing strength of diamond	High	Low
Cutting material	Marble, Granite, Porcelain Tile	Marble
Precision of cutting	Middle	High

Electroplated Diamond core for Angle Grinder



Range	Outer dia. mm	Thread mm	Dry/Wet	Part No.
Specialized	25	M14	Dry	D-35025
	30	M14	Dry	D-35019
	35	M14	Dry	D-35003
	40	M14	Dry	D-37007
	45	M14	Dry	D-37013

Vacuum brazed Diamond core for Angle Grinder



Range	Outer dia. mm	Thread mm	Dry/Wet	Part No.
Specialized	5	M10	Dry	D-75063
	5	M14	Dry	D-61064
	6	M10	Dry	D-75079
	6	M14	Dry	D-61070
	8	M10	Dry	D-75085
	8	M14	Dry	D-61086
	10	M10	Dry	D-75091
	10	M14	Dry	D-61092
	12	M10	Dry	D-75100
	12	M14	Dry	D-61101
	14	M10	Dry	D-75116
	14	M14	Dry	D-44432
	16	M10	Dry	D-75122
	16	M14	Dry	D-44448
	19	M10	Dry	D-75138
	20	M10	Dry	D-75144
	20	M14	Dry	D-44454
	22	M14	Dry	D-44460
	25	M10	Dry	D-75150
	25	M14	Dry	D-44476
	26	M10	Dry	D-75166
	27	M14	Dry	D-44482
	30	M14	Dry	D-44498
	32	M10	Dry	D-75172
	32	M14	Dry	D-44507
	35	M14	Dry	D-44513
	37	M10	Dry	D-75188
	38	M14	Dry	D-44529
	40	M10	Dry	D-75194
	40	M14	Dry	D-44535
	45	M14	Dry	D-44541

Range	Outer dia. mm	Thread mm	Dry/Wet	Part No.
Specialized	50	M10	Dry	D-75203
	51	M14	Dry	D-44557
	55	M14	Dry	D-44563
	57	M14	Dry	D-44579
	60	M14	Dry	D-44585
	65	M14	Dry	D-44591
	67	M14	Dry	D-44600
	68	M14	Dry	D-44616
	70	M14	Dry	D-44622
	75	M14	Dry	D-44638
	80	M14	Dry	D-44644
83	M14	Dry	D-44650	

Vacuum brazed Diamond pin drill bit



Range	Outer dia. mm	Shank mm	Dry/Wet	Part No.
★★★★☆	6	12.5	Dry	B-51823
	8	12.5	Dry	B-51839
	10	12.5	Dry	B-51845

Diamond polishing pad for Stone Polisher



Range	Outer dia. mm	Dry/Wet	Note	Backing color	Part No.
★★★★☆	100	Wet	Grit 50	Blue	D-15584
			Grit 100	Yellow	D-15590
			Grit 200	Orange	D-15609
			Grit 400	Red	D-15615
			Grit 800	Dark green	D-15621
			Grit 1500	Light green	D-15637
			Grit 3000	Brown	D-15643
			Buff(Finishing)	Green	D-15659
★★★☆☆	100	Wet	Grit 50	Blue	D-37035
			Grit 100	Yellow	D-37041
			Grit 200	Orange	D-37057
			Grit 400	Red	D-37063
			Grit 800	Green	D-37079
			Grit 1500	Light blue	D-37085
			Grit 3000	Black	D-37091

Diamond polishing pad for Stone Polisher Assortment



Range	Outer dia. mm	Dry/Wet	Note	Part No.
★★★★☆	100	Wet	(Set contents, Grit 50, 100, 200, 400, 800, 1500, 3000, Buff (Finishing))	D-15805

ACCESSORIES

▣ Planing / Routering



Wood



Aluminum



High speed steel

Planer blade/ HSS



Range	Size mm(inch)	Note	Sales Pkg Qty	Part No.
★★★★☆	400	-	2	793019-3
★★★★☆	170(6-3/4)	General pkg with 3 languages	2	D-63666
	155(6-1/8)		2	D-63915
	155(6-1/8)		2	D-70910
	136	-	2	D-71227
	110	-	2	D-71211
★★★★☆	82	-	2	D-16346
	80(3-1/8)	General pkg with 3 languages	2	D-65501
★☆☆☆☆	82	-	2	D-67228
	82	-	10	D-67234

Planer blade/ TC



Range	Size mm	Sales Pkg Qty	Part No.
★★★★☆	155	2	793015-1
	306	2	793137-7
★★★★☆	110	2	D-08822
	82	2	D-07967
★☆☆☆☆	82	2	D-72207

Mini planer blade/ HSS



Range	Size mm(inch)	Note	Sales Pkg Qty	Part No.
★★★★☆	312	General pkg with 3 languages	2	B-02870
	306(12)		2	793346-8
★★★★☆	155	-	2	B-02864
	50	-	2	A-85400

Mini planer blade/ TC



Range	Size mm	Note	Sales Pkg Qty	Part No.
★★★★☆	82	-	2	A-82921
	82	-	2	D-07945
★★★★☆	82	With plates	2	D-07951
	82		10	D-35302
★☆☆☆☆	82	-	2	D-70823
	82	-	10	D-70839

Straight bit 1flute



Range	Shank dia. mm(inch)	Overall dia. mm(inch)	Length mm(inch)	Carbide height mm(inch)	Sales pkg q'ty	Part No.	
★★★★☆	6	6	50	18	1	D-09167	
	(1/4)	(15/64)	(2-1/32)	(23/32)	1	D-09173	
	6	6	51	19	1	D-47416	
	6	6	51	19	1	D-67701	
	8	3	51	13	1	D-47379	
	8	3	51	13	1	D-67664	
	8	4	48	13	1	D-67670	
	8	4	51	13	1	D-47385	
	8	5	48	13	1	D-47391	
	8	5	48	13	1	D-67686	
	8	6	51	19	1	D-47400	
	8	6	51	19	1	D-67692	
	★★★★☆	(1/4)	(1/8)	(2)	(1/2)	1	D-49002
		(1/4)	(1/8)	(2)	(1/2)	1	D-68862
		(1/4)	(5/32)	(2)	(1/2)	1	D-49018
(1/4)		(5/32)	(2)	(1/2)	1	D-68878	
(1/4)		(3/16)	(1-7/8)	(1/2)	1	D-49024	
(1/4)		(3/16)	(1-7/8)	(1/2)	1	D-68884	
(1/4)		(1/4)	(2)	(3/4)	1	D-49030	
(1/4)		(1/4)	(2)	(3/4)	1	D-68890	
(1/2)		(1/4)	(2-1/2)	(3/4)	1	D-62739	
(1/2)		(1/4)	(2-1/2)	(3/4)	1	D-68909	
(1/2)	(3/8)	(2-1/2)	(1)	1	D-62745		
(1/2)	(3/8)	(2-1/2)	(1)	1	D-68915		

Straight bit 2flute



Range	Shank dia. mm(inch)	Overall dia. mm(inch)	Length mm(inch)	Carbide height mm(inch)	Sales pkg q'ty	Part No.	
★★★★☆	6	8	52	20	1	D-09260	
	6	20	52	20	1	D-09313	
	12	10	38	30	1	D-10182	
	12	12	61	30	1	D-07892	
	(1/4)	(5/16)	(2-1/64)	(3/4)	1	D-15388	
	(1/4)	(3/4)	(2-1/64)	(3/4)	1	D-15431	
	(1/2)	(25/64)	(2-47/64)	(1)	1	D-15512	
	(1/2)	(15/32)	(2-13/32)	(1-3/16)	1	D-07901	
	★★★★☆	6	6	48	16	1	D-47422
		6	6	48	16	1	D-67717
6		6	57	25	1	D-47438	
6		6	57	25	1	D-67723	
6		8	51	19	1	D-47444	
6		8	51	19	1	D-67739	
6		8	57	25.4	1	D-47450	
6		8	57	25.4	1	D-67745	
6		10	57	25.4	1	D-47466	
6		10	57	25.4	1	D-67751	
6		12	64	32	1	D-47472	
6		12	64	32	1	D-67767	
6		14	51	19	1	D-47488	
6		14	51	19	1	D-67773	
6		20	51	19	1	D-47494	
6		20	51	19	1	D-67789	
8		6	48	16	1	D-47503	
8		6	48	16	1	D-67795	
8		6	51	19	1	D-47519	
8		6	51	19	1	D-67804	
8		8	51	19	1	D-47525	
8		8	51	19	1	D-67810	
8		10	51	19	1	D-47531	
8		10	51	19	1	D-67826	
8		12	51	19	1	D-47547	
8		12	51	19	1	D-67832	
8		14	51	19	1	D-47553	
8		14	51	19	1	D-67848	

Range	Shank dia. mm(inch)	Overall dia. mm(inch)	Length mm(inch)	Carbide height mm(inch)	Sales pkg q'ty	Part No.
★★★★★	8	16	51	19	1	D-47569
	8	16	51	19	1	D-67854
	8	18	51	19	1	D-47575
	8	18	51	19	1	D-67860
	8	20	51	19	1	D-47581
	8	20	51	19	1	D-67876
	8	22	57	25.4	1	D-47597
	8	22	57	25.4	1	D-67882
	8	24	57	25.4	1	D-47606
	8	24	57	25.4	1	D-67898
	12	8	70	25	1	D-47612
	12	8	70	25	1	D-67907
	12	10	70	25.4	1	D-47628
	12	10	70	25.4	1	D-67913
	12	12	73	32	1	D-47634
	12	12	73	32	1	D-67929
	12	14	73	32	1	D-47640
	12	14	73	32	1	D-67935
	12	16	73	32	1	D-47656
	12	16	73	32	1	D-67941
12	19	73	32	1	D-47662	
12	19	73	32	1	D-67957	
12	22	73	32	1	D-47678	
12	22	73	32	1	D-67963	
12	25	73	32	1	D-47684	
12	25	73	32	1	D-67979	
(1/4)	(1/4)	(1-7/8)	(5/8)	1	D-49096	
(1/4)	(1/4)	(1-7/8)	(5/8)	1	D-68965	
(1/4)	(1/4)	(2)	(3/4)	1	D-49105	
(1/4)	(1/4)	(2)	(3/4)	1	D-68971	
(1/4)	(1/4)	(2-1/4)	(1)	1	D-49052	
(1/4)	(1/4)	(2-1/4)	(1)	1	D-68921	
(1/4)	(5/16)	(2)	(3/4)	1	D-49111	
(1/4)	(5/16)	(2)	(3/4)	1	D-68987	
(1/4)	(5/16)	(2-1/4)	(1)	1	D-49068	
(1/4)	(5/16)	(2-1/4)	(1)	1	D-68937	
(1/4)	(3/8)	(2)	(3/4)	1	D-49127	
(1/4)	(3/8)	(2)	(3/4)	1	D-68993	
(1/4)	(3/8)	(2-1/4)	(1)	1	D-49074	
(1/4)	(3/8)	(2-1/4)	(1)	1	D-68943	
(1/4)	(1/2)	(2)	(3/4)	1	D-49133	
(1/4)	(1/2)	(2)	(3/4)	1	D-69004	
(1/4)	(1/2)	(2-1/2)	(1-1/4)	1	D-49080	
(1/4)	(1/2)	(2-1/2)	(1-1/4)	1	D-68959	
(1/4)	(9/16)	(2)	(3/4)	1	D-49149	
(1/4)	(9/16)	(2)	(3/4)	1	D-69010	
(1/4)	(5/8)	(2)	(3/4)	1	D-49155	
(1/4)	(5/8)	(2)	(3/4)	1	D-69026	
(1/4)	(23/32)	(2)	(3/4)	1	D-49161	
(1/4)	(23/32)	(2)	(3/4)	1	D-69032	
(1/4)	(3/4)	(2)	(3/4)	1	D-49177	
(1/4)	(3/4)	(2)	(3/4)	1	D-69048	
(1/2)	(1/4)	(2-1/2)	(3/4)	1	D-62751	
(1/2)	(1/4)	(2-1/2)	(3/4)	1	D-69054	
(1/2)	(5/16)	(2-3/4)	(1)	1	D-49183	
(1/2)	(5/16)	(2-3/4)	(1)	1	D-69060	
(1/2)	(3/8)	(2-7/8)	(1)	1	D-49199	
(1/2)	(3/8)	(2-7/8)	(1)	1	D-69076	
(1/2)	(1/2)	(2-5/8)	(1)	1	D-62767	
(1/2)	(1/2)	(2-5/8)	(1)	1	D-69082	
(1/2)	(1/2)	(2-7/8)	(1-1/4)	1	D-49208	
(1/2)	(1/2)	(2-7/8)	(1-1/4)	1	D-69098	
(1/2)	(1/2)	(3)	(1-1/2)	1	D-62773	
(1/2)	(1/2)	(3)	(1-1/2)	1	D-69107	
(1/2)	(1/2)	(4)	(2)	1	D-62810	
(1/2)	(1/2)	(4)	(2)	1	D-69200	
(1/2)	(1/2)	(4-1/2)	(2-1/2)	1	D-58512	
(1/2)	(1/2)	(4-1/2)	(2-1/2)	1	D-69191	
(1/2)	(9/16)	(2-7/8)	(1-1/4)	1	D-49214	
(1/2)	(9/16)	(2-7/8)	(1-1/4)	1	D-69113	
(1/2)	(5/8)	(2-7/8)	(1-1/4)	1	D-49220	
(1/2)	(5/8)	(2-7/8)	(1-1/4)	1	D-69129	
(1/2)	(3/4)	(2-5/8)	(1)	1	D-62789	
(1/2)	(3/4)	(2-5/8)	(1)	1	D-69135	
(1/2)	(3/4)	(2-7/8)	(1-1/4)	1	D-49236	
(1/2)	(3/4)	(2-7/8)	(1-1/4)	1	D-69141	
(1/2)	(3/4)	(3)	(1-1/2)	1	D-62795	
(1/2)	(3/4)	(3)	(1-1/2)	1	D-69157	
(1/2)	(7/8)	(2-5/8)	(1)	1	D-62804	
(1/2)	(7/8)	(2-5/8)	(1)	1	D-69163	
(1/2)	(7/8)	(2-7/8)	(1-1/4)	1	D-49242	
(1/2)	(7/8)	(2-7/8)	(1-1/4)	1	D-69179	
(1/2)	(1)	(2-7/8)	(1-1/4)	1	D-49258	
(1/2)	(1)	(2-7/8)	(1-1/4)	1	D-69185	

Straight bit 2flute with top bearing



Range	Shank dia. (inch)	Overall dia. (inch)	Length (inch)	Carbide height (inch)	Sales pkg q'ty	Part No.
★★★★★	(1/4)	(1/2)	(1-7/8)	(1/4)	1	D-58497
	(1/4)	(1/2)	(1-7/8)	(1/4)	1	D-69353
	(1/4)	(1/2)	(2-5/8)	(1)	1	D-58506
	(1/4)	(1/2)	(2-5/8)	(1)	1	D-69369
	(1/2)	(3/4)	(2-13/16)	(1)	1	D-62826
	(1/2)	(3/4)	(2-13/16)	(1)	1	D-69216

Flush trim bit 2flute



Range	Shank dia. mm(inch)	Overall dia. mm(inch)	Length mm(inch)	Carbide height mm(inch)	Sales pkg q'ty	Part No.
★★★★★	6	9.5	58	25.4	1	D-09472
	(1/4)	(3/8)	(2-39/64)	(1)	1	D-04313
★★★★★	6	9.5	67	26	1	D-47690
	6	9.5	67	26	1	D-67985
	6	12.7	56	13	1	D-47709
	6	12.7	56	13	1	D-67991
	6	12.7	69	26	1	D-47715
	6	12.7	69	26	1	D-68002
	8	9.5	67	26	1	D-47721
	8	9.5	67	26	1	D-68018
	8	12.7	56	13	1	D-47737
	8	12.7	56	13	1	D-68024
	8	12.7	69	26	1	D-47743
	8	12.7	69	26	1	D-68030
	(1/4)	(1/4)	(2-1/8)	(1/2)	1	D-58528
	(1/4)	(1/4)	(2-1/8)	(1/2)	1	D-69266
	(1/4)	(3/8)	(2-1/8)	(1/2)	1	D-58534
	(1/4)	(3/8)	(2-1/8)	(1/2)	1	D-69272
	(1/4)	(3/8)	(2-5/8)	(1)	1	D-49264
	(1/4)	(3/8)	(2-5/8)	(1)	1	D-69238
	(1/4)	(1/2)	(2-3/16)	(1/2)	1	D-49270
	(1/4)	(1/2)	(2-3/16)	(1/2)	1	D-69244
(1/4)	(1/2)	(2-11/16)	(1)	1	D-49286	
(1/4)	(1/2)	(2-11/16)	(1)	1	D-69250	
(1/2)	(1/2)	(3)	(1)	1	D-58540	
(1/2)	(1/2)	(3)	(1)	1	D-69288	
(1/2)	(1/2)	(3-19/32)	(1-1/2)	1	D-62832	
(1/2)	(1/2)	(3-19/32)	(1-1/2)	1	D-69294	
(1/2)	(1/2)	(4-1/64)	(2)	1	D-62848	
(1/2)	(1/2)	(4-1/64)	(2)	1	D-69303	
(1/2)	(3/4)	(3)	(1)	1	D-62854	
(1/2)	(3/4)	(3-9/32)	(1)	1	D-69319	
(1/2)	(3/4)	(3-5/16)	(1-1/4)	1	D-62860	
(1/2)	(3/4)	(3-5/16)	(1-1/4)	1	D-69325	

Flush trim bit 3flute



Range	Shank dia. mm(inch)	Overall dia. mm(inch)	Length mm(inch)	Carbide height mm(inch)	Sales pkg q'ty	Part No.
★★★★★	8	12.7	69	26	1	D-47759
	8	12.7	69	26	1	D-68046
	12	12.7	90	38	1	D-47765
	12	12.7	90	38	1	D-68052
	(1/4)	(1/2)	(2-11/16)	(1)	1	D-49292
	(1/4)	(1/2)	(2-11/16)	(1)	1	D-69331
	(1/2)	(1/2)	(3-19/32)	(1-1/2)	1	D-49301
(1/2)	(1/2)	(3-19/32)	(1-1/2)	1	D-69347	

Panel pilot bit



Range	Shank dia. mm(inch)	Overall dia. mm(inch)	Length mm(inch)	Carbide height mm(inch)	Sales pkg q'ty	Part No.
★★★★☆	6	6	65	19	1	D-09335
	8	8	32	19	1	D-10578
	12	12	38	25.4	1	D-10584
★★★☆☆	6	6.35	65	19	1	D-47771
	6	6.35	65	19	1	D-68068
	8	6.35	65	19	1	D-47787
	8	6.35	65	19	1	D-68074
	12	9.5	75	26	1	D-47793
	12	9.5	76	26	1	D-68080
	(1/4)	(1/4)	(2-9/16)	(3/4)	1	D-49317
	(1/4)	(1/4)	(2-9/16)	(3/4)	1	D-69375
	(1/2)	(3/8)	(3)	(1)	1	D-49323
	(1/2)	(3/8)	(3)	(1)	1	D-69381
	(1/2)	(1/2)	(3-9/16)	(1-1/8)	1	D-63133
	(1/2)	(1/2)	(3-5/8)	(1-17/64)	1	D-58556

Sash router bit



Range	Shank dia. mm(inch)	Overall dia. mm(inch)	Length mm(inch)	Carbide height mm(inch)	Sales pkg q'ty	Part No.
★★★★☆	6	6	65	18	1	D-16988
	(1/4)	(15/64)	(2-9/16)	(45/64)	1	D-16972

Hinge mortising bit



Range	Shank dia. (inch)	Overall dia. (inch)	Length (inch)	Carbide height (inch)	Sales pkg q'ty	Part No.
★★★☆☆	(1/4)	(1/2)	(2)	(3/4)	1	D-69222
	(1/4)	(1/2)	(2-1/64)	(1-17/64)	1	D-58562
	(1/2)	(1/2)	(2-3/8)	(3/4)	1	D-63149

Core box bit



Range	Shank dia. mm(inch)	Overall dia. mm(inch)	Length mm(inch)	Carbide height mm(inch)	R1 mm(inch)	Sales pkg q'ty	Part No.
★★★★☆	8	6.35	38	6.35	3.2	1	D-47977
	8	6.35	38	6.35	3.2	1	D-68264
	8	7.9	40	8	4	1	D-47983
	8	7.9	40	8	4	1	D-68270
	8	9.5	41	9.5	4.8	1	D-47999
	8	9.5	41	9.5	4.8	1	D-68286
	8	12.7	41	10	6.35	1	D-48000
	8	12.7	41	10	6.35	1	D-68292
	8	15.8	45	12.7	7.9	1	D-48016
	8	15.8	45	12.7	7.9	1	D-68301
	12	15.8	54	12.7	7.9	1	D-48022
	12	15.8	54	12.7	7.9	1	D-68317
★★★☆☆	12	19	51	12.7	9.5	1	D-48038
	12	25.4	57	16	12.7	1	D-48044

Range	Shank dia. mm(inch)	Overall dia. mm(inch)	Length mm(inch)	Carbide height mm(inch)	R1 mm(inch)	Sales pkg q'ty	Part No.
★★★☆☆	(1/4)	(1/4)	(1-1/2)	(1/4)	(1/8)	1	D-49448
	(1/4)	(1/4)	(1-1/2)	(1/4)	(1/8)	1	D-69543
	(1/4)	(5/16)	(1-37/64)	(5/16)	(5/32)	1	D-49454
	(1/4)	(5/16)	(1-37/64)	(5/16)	(5/32)	1	D-69559
	(1/4)	(3/8)	(1-5/8)	(3/8)	(3/16)	1	D-49460
	(1/4)	(3/8)	(1-5/8)	(3/8)	(3/16)	1	D-69565
	(1/4)	(1/2)	(1-5/8)	(3/8)	(1/4)	1	D-49476
	(1/4)	(1/2)	(1-5/8)	(3/8)	(1/4)	1	D-69571
	(1/4)	(5/8)	(1-3/4)	(1/2)	(5/16)	1	D-49482
	(1/4)	(5/8)	(1-3/4)	(1/2)	(5/16)	1	D-69587
	(1/2)	(1/4)	(2)	(1/4)	(1/8)	1	D-62929
	(1/2)	(5/16)	(2)	(5/16)	(5/32)	1	D-62935
	(1/2)	(3/8)	(2)	(3/8)	(3/16)	1	D-62941
	(1/2)	(1/2)	(2)	(3/8)	(1/4)	1	D-62957
	(1/2)	(5/8)	(2-1/8)	(1/2)	(5/16)	1	D-49498
	(1/2)	(3/4)	(2)	(1/2)	(3/8)	1	D-49507
	(1/2)	(3/4)	(2)	(1/2)	(3/8)	1	D-69593
	(1/2)	(1)	(2-1/4)	(5/8)	(1/2)	1	D-49513
	(1/2)	(1)	(2-1/4)	(5/8)	(1/2)	1	D-69602
	(1/2)	(1)	(2-9/32)	(11/16)	(1/2)	1	D-62963
	(1/2)	(1-1/4)	(2-3/8)	(3/4)	(5/8)	1	D-62979
	(1/2)	(1-1/4)	(2-3/8)	(3/4)	(5/8)	1	D-69618
	(1/2)	(1-1/2)	(2-7/8)	(7/8)	(3/4)	1	D-62985

Round nose bit



Range	Shank dia. mm(inch)	Overall dia. mm(inch)	Length mm(inch)	Carbide height mm(inch)	R1 mm(inch)	Sales pkg q'ty	Part No.
★★★★☆	6	6	48	13	3	1	D-09329
	6	6.35	44	12.7	3.2	1	D-47802
	6	6.35	44	12.7	3.2	1	D-68096
	6	9.5	44	12.7	4.8	1	D-47818
	6	9.5	44	12.7	4.8	1	D-68105
	6	12.7	51	19	6.35	1	D-47824
	6	12.7	51	19	6.35	1	D-68111
	8	6.35	44	12.7	3.2	1	D-47830
	8	6.35	44	12.7	3.2	1	D-68127
	8	9.5	44	12.7	4.8	1	D-47846
	8	9.5	44	12.7	4.8	1	D-68133
	8	12.7	51	19	6.35	1	D-47852
	8	12.7	51	19	6.35	1	D-68149
	(1/4)	(1/4)	(1-3/4)	(1/2)	(1/8)	1	D-49345
	(1/4)	(1/4)	(1-3/4)	(1/2)	(1/8)	1	D-69406
	(1/4)	(3/8)	(1-3/4)	(1/2)	(3/16)	1	D-49351
	(1/4)	(3/8)	(1-3/4)	(1/2)	(3/16)	1	D-69412
	★★★☆☆	(1/4)	(1/2)	(2)	(3/4)	(1/4)	1
(1/4)		(1/2)	(2)	(3/4)	(1/4)	1	D-69397
(1/2)		(3/8)	(2-1/4)	(1/2)	(3/16)	1	D-62876
(1/2)		(3/8)	(2-1/4)	(1/2)	(3/16)	1	D-69428
(1/2)		(1/2)	(2-3/8)	(3/4)	(1/4)	1	D-62882
(1/2)		(1/2)	(2-3/8)	(3/4)	(1/4)	1	D-69434
(1/2)		(3/4)	(2-5/8)	(1)	(3/8)	1	D-62898
(1/2)		(3/4)	(2-5/8)	(1)	(3/8)	1	D-69440

Ball groove bit

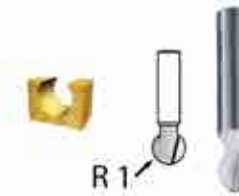

Range	Shank dia. mm(inch)	Overall dia. mm(inch)	Length mm(inch)	Carbide height mm(inch)	R1 mm(inch)	Sales pkg q'ty	Part No.
★★★★☆	8	9.5	41	8.3	4.8	1	D-48119
	8	12.7	44	11.4	6.4	1	D-48125
	8	15.9	48	14.8	7.9	1	D-48131
	8	19	51	18.2	9.5	1	D-48147
	(1/4)	(3/8)	(1-5/8)	(21/64)	(3/16)	1	D-49585
★★★☆☆	(1/4)	(1/2)	(1-3/4)	(29/64)	(1/4)	1	D-49591
	(1/4)	(1/2)	(1-3/4)	(29/64)	(1/4)	1	D-69668
	(1/4)	(5/8)	(1-7/8)	(37/64)	(5/16)	1	D-49600
	(1/4)	(3/4)	(2)	(23/32)	(3/8)	1	D-49616

V groove bit

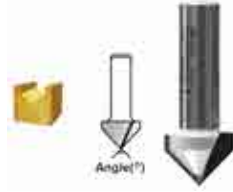

Range	Shank dia. mm(inch)	Overall dia. mm(inch)	Length mm(inch)	Carbide height mm(inch)	Angle(°)	Sales pkg q'ty	Part No.
★★★★☆	6	19	53	20	60	1	D-09391
	6	20	47	15	30	1	D-09379
	(1/4)	(45/64)	(1-7/8)	(5/8)	90	1	D-15453
★★★★☆	6	12.7	45	12.7	90	1	D-47868
	6	12.7	45	12.7	90	1	D-68155
	6	12.7	48	16	60	1	D-47874
	6	12.7	48	16	60	1	D-68161
	6	19	48	16	90	1	D-47880
	6	19	48	16	90	1	D-68177
	8	12.7	45	12.7	90	1	D-47896
	8	12.7	45	12.7	90	1	D-68183
	8	12.7	48	16	60	1	D-47961
	8	12.7	48	16	60	1	D-68258
	8	15.9	44	12.7	90	1	D-47905
	8	15.9	44	12.7	90	1	D-68199
	8	19	48	16	90	1	D-47933
	8	19	48	16	90	1	D-68220
	12	12.7	54	12.7	90	1	D-47911
	12	12.7	54	12.7	90	1	D-68208
	12	15.9	51	12.7	90	1	D-47927
	12	15.9	51	12.7	90	1	D-68214
	12	19	57	16	90	1	D-47949
	12	19	57	16	90	1	D-68236
	12	28.6	60	22.2	90	1	D-47955
	12	28.6	60	22.2	90	1	D-68242
	(1/4)	(1/2)	(1-3/4)	(1/2)	90	1	D-49389
	(1/4)	(1/2)	(1-3/4)	(1/2)	90	1	D-69478
	(1/4)	(1/2)	(1-7/8)	(5/8)	60	1	D-49367
	(1/4)	(1/2)	(1-7/8)	(5/8)	60	1	D-69456
	(1/4)	(5/8)	(1-3/4)	(1/2)	90	1	D-49395
	(1/4)	(5/8)	(1-3/4)	(1/2)	90	1	D-69484
	(1/4)	(3/4)	(1-7/8)	(5/8)	90	1	D-49373
	(1/4)	(3/4)	(1-7/8)	(5/8)	90	1	D-69462
	(1/2)	(1/2)	(2-1/8)	(1/2)	90	1	D-49404
	(1/2)	(1/2)	(2-1/8)	(1/2)	90	1	D-69490
(1/2)	(5/8)	(2)	(1/2)	90	1	D-49410	
(1/2)	(5/8)	(2)	(1/2)	90	1	D-69509	
(1/2)	(3/4)	(2-1/4)	(5/8)	90	1	D-49426	
(1/2)	(3/4)	(2-1/4)	(5/8)	90	1	D-69521	
(1/2)	(7/8)	(2-1/4)	(5/8)	90	1	D-62907	
(1/2)	(7/8)	(2-1/4)	(5/8)	90	1	D-69515	
(1/2)	(1)	(2-3/8)	(3/4)	90	1	D-62913	
(1/2)	(1-1/8)	(2-3/8)	(7/8)	90	1	D-49432	
(1/2)	(1-1/8)	(2-3/8)	(7/8)	90	1	D-69537	

Point cut roundover bit

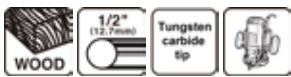

Range	Shank dia. (inch)	Overall dia. (inch)	Length (inch)	Carbide height (inch)	R1 (inch)	Sales pkg q'ty	Part No.
★★★★☆	(1/2)	(3/8)	(2-1/4)	(3/8)	(3/16)	1	D-63177

Keyhole bit



Range	Shank dia. mm(inch)	Overall dia. mm(inch)	Length mm(inch)	Carbide height mm(inch)	Sales pkg q'ty	Part No.
★★★★☆	8	9.5	48	10.5	1	D-48907
	8	9.5	48	10.5	1	D-68812
	(1/4)	(3/8)	(1-7/8)	(13/32)	1	D-50217
	(1/4)	(3/8)	(1-7/8)	(13/32)	1	D-70063

Slatwall bit



Range	Shank dia. mm(inch)	Overall dia. mm	Length mm	Carbide height mm	Sales pkg q'ty	Part No.
★★★★☆	12	38	55.5	17.5	1	D-61852
	(1/2)	38	55.5	17.5	1	D-61868

Ovolo bit

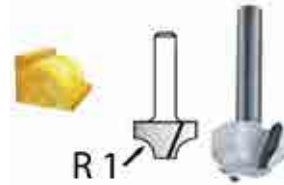

Range	Shank dia. mm(inch)	Overall dia. mm(inch)	Length mm(inch)	Carbide height mm(inch)	R1 mm(inch)	Sales pkg q'ty	Part No.
★★★★☆	6	16	41	9	4	1	D-09357
	6	25	45	13	8	1	D-09363
★★★★☆	6	19	43	9.5	3.2	1	D-48278
	6	19	43	9.5	3.2	1	D-68373
	6	25.4	45	13.5	6.35	1	D-48284
	6	25.4	45	13.5	6.35	1	D-68389
	(1/4)	(3/4)	(1-11/16)	(3/8)	(1/8)	1	D-49747
	(1/4)	(3/4)	(1-11/16)	(3/8)	(1/8)	1	D-69733
	(1/4)	(1)	(1-13/16)	(17/32)	(1/4)	1	D-49753
	(1/2)	(3/4)	(1-7/8)	(3/8)	(1/8)	1	D-63024
	(1/2)	(1)	(2-7/64)	(17/32)	(1/4)	1	D-63030

Roundover bit



Range	Shank dia. mm(inch)	Overall dia. mm(inch)	Length mm(inch)	Carbide height mm(inch)	R1 mm(inch)	Sales pkg q'ty	Part No.
★★★★☆	6	19	42	9.5	3	1	D-09422
	6	25	45	13	6	1	D-09444
★★★★☆	(1/4)	(7/8)	(2-3/16)	(1/2)	(3/16)	1	D-15475
	6	19	53	9.5	3.2	1	D-48290
	6	19	53	9.5	3.2	1	D-68395
	6	20.6	52	10	4	1	D-48309
	6	20.6	52	10	4	1	D-68404
	6	25.4	56	13.5	6.35	1	D-48315
	6	25.4	56	13.5	6.35	1	D-68410
	6	28.6	57	14.5	7.9	1	D-48321
	6	28.6	57	14.5	7.9	1	D-68426
	6	31.8	60	16.7	9.5	1	D-48337
	6	31.8	60	16.7	9.5	1	D-68432
	8	17.3	51	8	2.3	1	D-48343
	8	17.3	51	8	2.3	1	D-68448
	8	19	53	9.5	3.2	1	D-48359
	8	19	53	9.5	3.2	1	D-68454
	8	20.7	52	10	4	1	D-48365
	8	20.7	52	10	4	1	D-68460
	8	22.2	55	12.7	4.8	1	D-48371
	8	22.2	55	12.7	4.8	1	D-68476
	8	25.4	56	13.5	6.35	1	D-48387
	8	25.4	56	13.5	6.35	1	D-68482
	8	28.6	57	14.5	7.9	1	D-48393
	8	28.6	57	14.5	7.9	1	D-68498
	8	31.8	60	16.7	9.5	1	D-48402
	8	31.8	60	16.7	9.5	1	D-68507
	8	38.1	62	19	12.7	1	D-48418
	8	38.1	62	19	12.7	1	D-68513
	12	50.8	76	25.4	19	1	D-48424
	12	50.8	76	25.4	19	1	D-68529
	(1/4)	(3/4)	(2-1/8)	(3/8)	(1/8)	1	D-49769
	(1/4)	(3/4)	(2-1/8)	(3/8)	(1/8)	1	D-69749
	(1/4)	(7/8)	(2-5/32)	(1/2)	(3/16)	1	D-49775
(1/4)	(7/8)	(2-5/32)	(1/2)	(3/16)	1	D-69755	
(1/4)	(1)	(2-1/4)	(17/32)	(1/4)	1	D-49781	
(1/4)	(1)	(2-1/4)	(17/32)	(1/4)	1	D-69761	

Range	Shank dia. mm(inch)	Overall dia. mm(inch)	Length mm(inch)	Carbide height mm(inch)	R1 mm(inch)	Sales pkg q'ty	Part No.
★★★★☆	(1/4)	(1-1/8)	(2-1/4)	(9/16)	(5/16)	1	D-49797
	(1/4)	(1-1/8)	(2-1/4)	(9/16)	(5/16)	1	D-69777
	(1/4)	(1-1/4)	(2-5/16)	(21/32)	(3/8)	1	D-49806
	(1/4)	(1-1/4)	(2-5/16)	(21/32)	(3/8)	1	D-69783
	(1/4)	(1-1/2)	(2-7/16)	(3/4)	(1/2)	1	D-49812
	(1/4)	(1-1/2)	(2-7/16)	(3/4)	(1/2)	1	D-69799
	(1/2)	(5/8)	(2-5/32)	(15/32)	(1/16)	1	D-63046
	(1/2)	(3/4)	(2-5/16)	(3/8)	(1/8)	1	D-63052
	(1/2)	(1-1/4)	(2-11/16)	(21/32)	(3/8)	1	D-63068
	(1/2)	(1-1/2)	(2-11/16)	(3/4)	(1/2)	1	D-63074
	(1/2)	(1-1/2)	(2-11/16)	(3/4)	(1/2)	1	D-69808
	(1/2)	(2)	(2-15/16)	(1)	(3/4)	1	D-49828
(1/2)	(2)	(2-15/16)	(1)	(3/4)	1	D-69814	

Double roundover bit

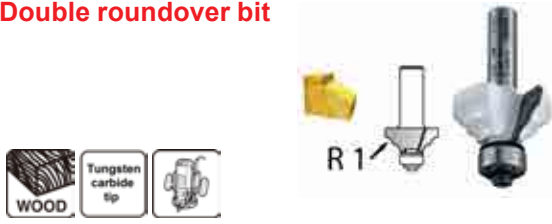

Range	Shank dia. mm(inch)	Overall dia. mm(inch)	Length mm(inch)	Carbide height mm(inch)	R1 mm(inch)	Sales pkg q'ty	Part No.
★★★★☆	8	28.6	51	12.7	4	1	D-48577
	8	28.6	51	12.7	4	1	D-68650
	(1/4)	(1-1/8)	(2)	(1/2)	(5/32)	1	D-49909
	(1/4)	(1-1/8)	(2)	(1/2)	(5/32)	1	D-69870

Beading bit

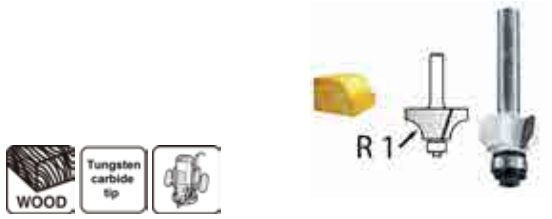

Range	Shank dia. mm(inch)	Overall dia. mm(inch)	Length mm(inch)	Carbide height mm(inch)	R1 mm(inch)	Sales pkg q'ty	Part No.
★★★★☆	6	21	42	9.5	4	1	D-09525
	6	28	45	13	8	1	D-09547
	6	17	49	8	2.3	1	D-48430
	6	17	49	8	2.3	1	D-68535
	6	19	52	9.5	3.2	1	D-48446
	6	19	52	9.5	3.2	1	D-68541
	6	20.3	51	10	4	1	D-48452
	6	20.3	51	10	4	1	D-68557
	6	22.2	53	12.7	4.8	1	D-48468
	6	22.2	53	12.7	4.8	1	D-68563
	6	28.6	56	14.5	7.9	1	D-48474
	6	28.6	56	14.5	7.9	1	D-68579
★★★★☆	8	17.3	49	8	2.3	1	D-48480
	8	17.3	49	8	2.3	1	D-68585
	8	19	52	9.5	3.2	1	D-48496
	8	19	52	9.5	3.2	1	D-68591
	8	20.7	51	10	4	1	D-48505
	8	22.2	53	13	4.8	1	D-48511
	8	25.4	55	13.5	6.35	1	D-48527
	8	25.4	55	13.5	6.35	1	D-68600
	8	28.6	56	14.5	7.9	1	D-48533
	8	28.6	56	14.5	7.9	1	D-68616
	8	31.8	58	17	9.5	1	D-48549
	8	31.8	58	17	9.5	1	D-68622
	8	38.1	60	19	12.7	1	D-48555
	8	38.1	60	19	12.7	1	D-68638
	12	50.8	75	25.4	19	1	D-48561
	12	50.8	75	25.4	19	1	D-68644
	(1/4)	(3/4)	(2-1/32)	(3/8)	(1/8)	1	D-49834
	(1/4)	(3/4)	(2-1/32)	(3/8)	(1/8)	1	D-69820
	(1/4)	(7/8)	(2-1/8)	(1/2)	(3/16)	1	D-49840
	(1/4)	(7/8)	(2-1/8)	(1/2)	(3/16)	1	D-69836
	(1/4)	(1)	(2-5/32)	(17/32)	(1/4)	1	D-49856
	(1/4)	(1)	(2-5/32)	(17/32)	(1/4)	1	D-69842
	(1/4)	(1-1/8)	(2-3/16)	(9/16)	(5/16)	1	D-49862
	(1/4)	(1-1/4)	(2-9/32)	(21/32)	(3/8)	1	D-49878
(1/4)	(1-1/4)	(2-9/32)	(21/32)	(3/8)	1	D-69858	
(1/4)	(1-1/2)	(2-3/8)	(3/4)	(1/2)	1	D-49884	
(1/4)	(1-1/2)	(2-3/8)	(3/4)	(1/2)	1	D-69864	
(1/2)	(2)	(2-61/64)	(1)	(3/4)	1	D-49890	

Plunge cut roundover bit



Range	Shank dia. mm(inch)	Overall dia. mm(inch)	Length mm(inch)	Carbide height mm(inch)	R1 mm(inch)	Sales pkg q'ty	Part No.
★★★★☆	8	19	45	12.7	6.35	1	D-48153
	8	19	45	12.7	6.35	1	D-68367
	8	25.4	48	16	9.5	1	D-48169
	8	38.1	60	28.6	12.7	1	D-48175
	(1/4)	(3/4)	(1-3/4)	(1/2)	(1/4)	1	D-49622
	(1/4)	(3/4)	(1-7/8)	(1/2)	(1/4)	1	D-69674
	(1/4)	(1)	(1-7/8)	(5/8)	(3/8)	1	D-49638
	(1/4)	(1)	(1-7/8)	(5/8)	(3/8)	1	D-69680
	(1/4)	(1-1/2)	(2-3/8)	(1-1/8)	(1/2)	1	D-49644

Cove bit



Range	Shank dia. mm(inch)	Overall dia. mm(inch)	Length mm(inch)	Carbide height mm(inch)	R1 mm(inch)	Sales pkg q'ty	Part No.
★★★★☆	6	20	40	8	4	1	D-09400
	6	25	45	13	8	1	D-09416
★★★★☆	8	15.9	49	6.35	1.6	1	D-48583
	8	17.5	49	6.35	2.4	1	D-48599
	8	19	46	9.7	3.2	1	D-48608
	8	22.2	56	12.7	4.8	1	D-48614
	8	22.2	56	12.7	4.8	1	D-68666
	8	28.6	56	12.7	7.9	1	D-48620
	8	28.6	56	12.7	7.9	1	D-68672
	8	31.8	56	14	9.5	1	D-48636
	8	31.8	56	14	9.5	1	D-68688
	8	38.1	58	15.4	12.7	1	D-48642
	(1/4)	(5/8)	(1-15/16)	(1/4)	(1/16)	1	D-49915
	(1/4)	(5/8)	(1-15/16)	(1/4)	(1/16)	1	D-69886
★★★★☆	(1/4)	(11/16)	(1-15/16)	(1/4)	(3/32)	1	D-49921
	(1/4)	(3/4)	(1-13/16)	(3/8)	(1/8)	1	D-49937
	(1/4)	(3/4)	(1-13/16)	(3/8)	(1/8)	1	D-69892
	(1/4)	(7/8)	(2-3/16)	(1/2)	(3/16)	1	D-49943
	(1/4)	(7/8)	(2-3/16)	(1/2)	(3/16)	1	D-69901
	(1/4)	(1-1/8)	(2-3/16)	(1/2)	(5/16)	1	D-49959
	(1/4)	(1-1/8)	(2-3/16)	(1/2)	(5/16)	1	D-69917
	(1/4)	(1-1/4)	(2-13/64)	(17/32)	(3/8)	1	D-49965
	(1/4)	(1-1/4)	(2-13/64)	(17/32)	(3/8)	1	D-69923
	(1/4)	(1-1/2)	(2-5/16)	(5/8)	(1/2)	1	D-49971
	(1/4)	(1-1/2)	(2-5/16)	(5/8)	(1/2)	1	D-69939
	(1/2)	(1-1/4)	(2-17/32)	(17/32)	(3/8)	1	D-63080
(1/2)	(1-1/2)	(2-9/16)	(5/8)	(1/2)	1	D-63096	
(1/2)	(1-3/4)	(2-11/16)	(3/4)	(5/8)	1	D-63105	
(1/2)	(2)	(2-7/8)	(7/8)	(3/4)	1	D-63111	

Cove with fillet bit



Range	Shank dia. mm(inch)	Overall dia. mm(inch)	Length mm(inch)	Carbide height mm(inch)	R1 mm(inch)	Sales pkg q'ty	Part No.
★★★★☆	6	22	42	10	3	1	D-09553
	6	25.4	54	12.7	4.8	1	D-48795
★★★★☆	6	25.4	54	12.7	4.8	1	D-68806
	(1/4)	(1)	(2-3/16)	(1/2)	(3/16)	1	D-50120
	(1/2)	(1-1/4)	(2-7/16)	(19/32)	(5/16)	1	D-63127

Chamfer bit



Range	Shank dia. mm(inch)	Overall dia. mm(inch)	Length mm(inch)	Carbide height mm(inch)	Angle(°)	Sales pkg q'ty	Part No.
★★★★☆	6	23	43	11	60	1	D-09494
	6	26	42	9.5	45	1	D-09488
	(1/4)	(1-1/8)	(2-7/64)	(7/16)	-	1	D-15506
	6	22.2	56	12.7	25	1	D-48664
	6	22.2	56	12.7	25	1	D-68703
	6	25.4	51	11	45	1	D-48658
	6	25.4	51	11	45	1	D-68694
	8	30.2	55	12.7	45	1	D-48670
	8	30.2	55	12.7	45	1	D-68719
	8	31.8	55	13.5	45	1	D-48686
	8	31.8	55	13.5	45	1	D-68725
	★★★★☆	8	34.9	59	16	45	1
8		34.9	59	16	45	1	D-68731
8		41.3	59	20	45	1	D-48701
8		41.3	59	20	45	1	D-68747
12		44.5	69	22.6	45	1	D-48717
12		44.5	69	22.6	45	1	D-68753
12		50.8	71	27	45	1	D-48723
(1/4)		(7/8)	(2-3/16)	(1/2)	25	1	D-49993
(1/4)		(7/8)	(2-3/16)	(1/2)	25	1	D-69951
(1/4)		(1)	(2)	(3/8)	45	1	D-49987
(1/4)		(1)	(2)	(3/8)	45	1	D-69945
(1/4)		(1-3/16)	(2-1/8)	(1/2)	45	1	D-50005
(1/4)	(1-3/16)	(2-1/8)	(1/2)	45	1	D-69967	
(1/4)	(1-1/4)	(2-11/64)	(17/32)	45	1	D-50011	
(1/4)	(1-1/4)	(2-11/64)	(17/32)	45	1	D-69973	
(1/4)	(1-3/8)	(2-5/16)	(5/8)	45	1	D-50027	
(1/4)	(1-5/8)	(2-5/16)	(13/16)	45	1	D-50033	
(1/4)	(1-5/8)	(2-5/16)	(13/16)	45	1	D-69989	
(1/2)	(1-3/4)	(2-11/16)	(29/32)	45	1	D-50049	
(1/2)	(2)	(2-13/16)	(1-1/16)	45	1	D-50055	

Ogee bit



Range	Shank dia. mm(inch)	Overall dia. mm(inch)	Length mm(inch)	Carbide height mm(inch)	R1 mm(inch)	Sales pkg q'ty	Part No.
★★★★☆	8	19	42	11	3.2	1	D-48181
	8	31.3	48	16	6.35	1	D-48197
	8	31.8	56	12.7	4.8	1	D-48773
	8	38.1	59	16	6.35	1	D-48789
	(1/4)	(3/4)	(1-11/16)	(7/16)	(1/8)	1	D-49650
	(1/4)	(3/4)	(1-11/16)	(7/16)	(1/8)	1	D-69696
	(1/4)	(1-15/64)	(1-7/8)	(5/8)	(1/4)	1	D-49666
	(1/4)	(1-1/4)	(2-3/16)	(1/2)	(3/16)	1	D-50108
	(1/4)	(1-1/2)	(2-5/16)	(5/8)	(1/4)	1	D-50114
	(1/4)	(1-1/2)	(2-5/16)	(5/8)	(1/4)	1	D-70035
	(1/2)	(3/4)	(1-15/16)	(7/16)	(1/8)	1	D-63018

Roman ogee bit



Range	Shank dia. mm(inch)	Overall dia. mm(inch)	Length mm(inch)	Carbide height mm(inch)	R1 mm(inch)	Sales pkg q'ty	Part No.
★★★★☆	6	24	42	10	2.5	1	D-09575
	6	28	44	12	3	1	D-09581
	6	25.4	52	9.5	3.2	1	D-48804
★★★★☆	6	28.6	55	13	4	1	D-48810
	6	28.6	55	13	4	1	D-68775
	8	28.6	55	13	4	1	D-48751
	8	28.6	55	13	4	1	D-68781
	8	38.1	60	17.5	6.35	1	D-48767
8	38.1	60	17.5	6.35	1	D-68797	

Range	Shank dia. mm(inch)	Overall dia. mm(inch)	Length mm(inch)	Carbide height mm(inch)	R1 mm(inch)	Sales pkg q'ty	Part No.
★★★★☆	(1/4)	(1-1/8)	(2-11/64)	(1/2)	(5/32)	1	D-50083
	(1/4)	(1-1/8)	(2-11/64)	(1/2)	(5/32)	1	D-70013
	(1/4)	(1-1/2)	(2-3/8)	(11/16)	(1/4)	1	D-50099
	(1/4)	(1-1/2)	(2-3/8)	(11/16)	(1/4)	1	D-70029

Roman ogee double bit



Range	Shank dia. (inch)	Overall dia. (inch)	Length (inch)	Carbide height (inch)	R1 (inch)	Sales pkg q'ty	Part No.
★★★★☆	(1/2)	(1-1/4)	(2-29/32)	(1-27/64)	(3/32)	1	D-63161

Classic roman ogee bit



Range	Shank dia. (inch)	Overall dia. (inch)	Length (inch)	Carbide height (inch)	R1 (inch)	Sales pkg q'ty	Part No.
★★★★☆	(1/2)	(1-3/8)	(2-9/16)	(5/8)	(3/16)	1	D-63236
	(1/2)	(1-3/8)	(2-9/16)	(5/8)	(3/16)	1	D-70150

Classic mold bit



Range	Shank dia. mm	Overall dia. mm	Length mm	Carbide height mm	R1 mm	Sales pkg q'ty	Part No.
★★★★☆	8	38.1	32	15.9	3.18	1	D-11704

Classical plunge bit



Range	Shank dia. mm(inch)	Overall dia. mm(inch)	Length mm(inch)	Carbide height mm(inch)	R1 mm(inch)	Sales pkg q'ty	Part No.
★★★★☆	8	12.7	41.5	9.5	2	1	D-48240
	8	19	43.1	11	3.2	1	D-48256
	(1/4)	(1/2)	(1-5/8)	(3/8)	(5/64)	1	D-49719
	(1/4)	(3/4)	(1-11/16)	(7/16)	(1/8)	1	D-49725
	(1/4)	(3/4)	(1-11/16)	(7/16)	(1/8)	1	D-69727

Classical bit



Range	Shank dia. mm(inch)	Overall dia. mm(inch)	Length mm(inch)	Carbide height mm(inch)	R1 mm(inch)	Sales pkg q'ty	Part No.
★★★★☆	8	22	54	13	3.2	1	D-48262
	(1/4)	(7/8)	(2-1/8)	(1/2)	(1/8)	1	D-49731

Classic panel bit



Range	Shank dia. mm(inch)	Overall dia. mm(inch)	Length mm(inch)	Carbide height mm(inch)	R1 mm(inch)	Sales pkg q'ty	Part No.
★★★★☆	8	12.7	42	10	2.4	1	D-48206
	8	19	44.7	12.7	4	1	D-48212
	12	25.4	54	16	5.6	1	D-48228
	12	31.8	57	19	8.7	1	D-48234
	(1/4)	(1/2)	(1-21/32)	(3/8)	(3/32)	1	D-49672
	(1/4)	(1/2)	(1-21/32)	(3/8)	(3/32)	1	D-69705
	(1/4)	(3/4)	(1-3/4)	(1/2)	(5/32)	1	D-49688
	(1/2)	(1)	(2-1/8)	(5/8)	(7/32)	1	D-49694
	(1/2)	(1)	(2-1/8)	(5/8)	(7/32)	1	D-69711
	(1/2)	(1-1/4)	(2-1/4)	(3/4)	(11/32)	1	D-49703

Bull nose bit



Range	Shank dia. (inch)	Overall dia. (inch)	Length (inch)	Carbide height (inch)	R1 (inch)	Sales pkg q'ty	Part No.
★★★★☆	(1/2)	(3/4)	(2-9/16)	(5/8)	(1/8)	1	D-63208
	(1/2)	(7/8)	(2-3/8)	(3/4)	(1/8)	1	D-63155
	(1/2)	(7/8)	(2-15/16)	(1)	(3/16)	1	D-63214
	(1/2)	(1)	(2-15/16)	(1)	(1/4)	1	D-63220

Edge beading bit



Range	Shank dia. (inch)	Overall dia. (inch)	Length (inch)	Carbide height (inch)	R1 (inch)	Sales pkg q'ty	Part No.
★★★★☆	(1/2)	(1)	(2-5/8)	(11/16)	(3/16)	1	D-63183
	(1/2)	(1-1/8)	(2-11/16)	(3/4)	(1/4)	1	D-63199

Triple bead bit



Range	Shank dia. (inch)	Overall dia. (inch)	Length (inch)	Carbide height (inch)	R1 (inch)	Sales pkg q'ty	Part No.
★★★★☆	(1/2)	(7/8)	(2-61/64)	(1)	(1/8)	1	D-63242

Full bead bit



Range	Shank dia. mm(inch)	Overall dia. mm(inch)	Length mm(inch)	Carbide height mm(inch)	R1 mm(inch)	Sales pkg q'ty	Part No.
★★★★☆	8	25.4	61.2	13	4.8	1	D-48826
	(1/4)	(1)	(2-13/32)	(1/2)	(3/16)	1	D-50136

Handrail bit Type2



Range	Shank dia. (inch)	Overall dia. (inch)	Length (inch)	Carbide height (inch)	Sales pkg q'ty	Part No.
★★★★☆	(1/2)	(1-3/8)	(3-7/16)	(1-1/2)	1	D-63258

Fish Handrail bit



Range	Shank dia. mm(inch)	Overall dia. mm(inch)	Length mm(inch)	Carbide height mm(inch)	Sales pkg q'ty	Part No.
★★★★☆	8	19	67.1	26	1	D-48832
	12	28.6	90.2	41	1	D-48848
	(1/4)	(3/4)	(2-5/8)	(1)	1	D-50142
	(1/2)	(1-1/8)	(3-17/32)	(1-5/8)	1	D-50158

Multi edge beading bit



Range	Shank dia. mm(inch)	Overall dia. mm(inch)	Length mm(inch)	Carbide height mm(inch)	Sales pkg q'ty	Part No.
★★★★☆	8	34.9	69.4	26	1	D-48860
	12	57.2	102.6	47.5	1	D-48876
	(1/4)	(1-3/8)	(2-3/4)	(1)	1	D-50170
	(1/2)	(2-1/4)	(4)	(1-7/8)	1	D-50186
	(1/2)	(2-1/4)	(4)	(1-7/8)	1	D-70041

French provincial classical bit



Range	Shank dia. mm(inch)	Overall dia. mm(inch)	Length mm(inch)	Carbide height mm(inch)	Sales pkg q'ty	Part No.
★★★★☆	12	44.5	79.2	28.6	1	D-48854
	(1/2)	(1-3/4)	(3-1/8)	(1-1/8)	1	D-50164

Rabbeting bit



Range	Shank dia. mm(inch)	Overall dia. mm(inch)	Length mm(inch)	Carbide height mm(inch)	Sales pkg q'ty	Part No.
★★★★☆	8	31.8	54.6	12.2	1	D-48739
	8	31.8	55	12.2	1	D-68769
	12	31.8	60.8	12.2	1	D-48745
	(1/4)	(1-1/4)	(2-1/8)	(1/2)	1	D-50061
	(1/4)	(1-1/4)	(2-1/8)	(1/2)	1	D-69995
	(1/2)	(1-1/4)	(2-3/16)	(1/2)	1	D-50077
	(1/2)	(1-1/4)	(2-3/16)	(1/2)	1	D-70007
	(1/2)	(1-1/4)	(2-3/16)	(1/2)	1	D-70007

Dovetail bit



Range	Shank dia. mm(inch)	Overall dia. mm(inch)	Length mm(inch)	Carbide height mm(inch)	Angle(°)	Sales pkg q'ty	Part No.	
	8	6.35	64	8	7.5	1	D-48050	
	8	9.5	40	9.5	9	1	D-48066	
	8	12.7	45	13	14	1	D-48072	
	8	12.7	45	13	14	1	D-68323	
	8	15	52	14.3	15	1	D-48088	
	8	15	52	14.3	15	1	D-68339	
	12	19	64	22.2	7	1	D-48094	
	12	19	64	22.2	7	1	D-68345	
	12	25.4	64	22.2	14	1	D-48103	
	12	25.4	64	22.2	14	1	D-68351	
	★★☆☆☆	(1/4)	(1/4)	(2-1/2)	(5/16)	7.5	1	D-49529
	★★☆☆☆	(1/4)	(1/4)	(2-1/2)	(5/16)	7.5	1	D-69624
★★☆☆☆	(1/4)	(3/8)	(1-9/16)	(3/8)	9	1	D-49535	
★★☆☆☆	(1/4)	(3/8)	(1-9/16)	(3/8)	9	1	D-69630	
★★☆☆☆	(1/4)	(1/2)	(1-3/4)	(1/2)	14	1	D-49541	
★★☆☆☆	(1/4)	(1/2)	(1-3/4)	(1/2)	14	1	D-69646	
★★☆☆☆	(1/4)	(19/32)	(2-3/64)	(9/16)	15	1	D-49557	
★★☆☆☆	(1/2)	(3/8)	(2-1/8)	(3/8)	9	1	D-62991	
★★☆☆☆	(1/2)	(3/8)	(2-1/8)	(3/8)	9	1	D-69652	
★★☆☆☆	(1/2)	(1/2)	(2-1/4)	(1/2)	14	1	D-63002	
★★☆☆☆	(1/2)	(3/4)	(2-1/2)	(7/8)	7	1	D-49563	
★★☆☆☆	(1/2)	(1)	(2-1/2)	(7/8)	14	1	D-49579	

Slotting cutter



Range	Shank dia. mm(inch)	Overall dia. mm(inch)	Length mm(inch)	Carbide height mm(inch)	Note	Sales pkg q'ty	Part No.	
	8	47.6	59	2	Slotting cutter with arbor	1	D-48941	
	8	47.6	59	2.5		1	D-48957	
	8	47.6	59	3		1	D-48963	
	8	47.6	59	3		1	D-68834	
	8	47.6	59	4		1	D-48979	
	8	47.6	59	4		1	D-68840	
	8	47.6	59	5		1	D-48985	
	8	47.6	59	5		1	D-68856	
	8	47.6	59	5.5		1	D-48991	
	★★☆☆☆	(1/4)	(1-7/8)	(2-5/16)		(5/64)	1	D-50245
	★★☆☆☆	(1/4)	(1-7/8)	(2-5/16)		(5/64)	1	D-70091
	★★☆☆☆	(1/4)	(1-7/8)	(2-5/16)		(3/32)	1	D-50251
★★☆☆☆	(1/4)	(1-7/8)	(2-5/16)	(3/32)	1	D-70100		
★★☆☆☆	(1/4)	(1-7/8)	(2-5/16)	(1/8)	1	D-50267		
★★☆☆☆	(1/4)	(1-7/8)	(2-5/16)	(1/8)	1	D-70116		
★★☆☆☆	(1/4)	(1-7/8)	(2-5/16)	(5/32)	1	D-50273		
★★☆☆☆	(1/4)	(1-7/8)	(2-5/16)	(5/32)	1	D-70122		
★★☆☆☆	(1/4)	(1-7/8)	(2-5/16)	(3/16)	1	D-50289		
★★☆☆☆	(1/4)	(1-7/8)	(2-5/16)	(3/16)	1	D-70138		
★★☆☆☆	(1/4)	(1-7/8)	(2-5/16)	(7/32)	1	D-50295		
★★☆☆☆	(1/4)	(1-7/8)	(2-5/16)	(7/32)	1	D-70144		

Reversible glue joint bit



Range	Shank dia. mm(inch)	Overall dia. mm(inch)	Length mm(inch)	Carbide height mm(inch)	Sales pkg q'ty	Part No.
★★☆☆☆	8	30.1	57.2	25.4	1	D-48913
	12	41.3	76.2	25.4	1	D-48929
	(1/2)	(1-5/8)	(3)	(1)	1	D-50223
	(1/2)	(1-5/8)	(3)	(1)	1	D-70079

Reversible rail and stile bit



Range	Shank dia. mm(inch)	Overall dia. mm(inch)	Length mm(inch)	Carbide height mm(inch)	Sales pkg q'ty	Part No.
★★☆☆☆	12	41	78.5	23.4	1	D-48882
	12	41	78.5	23.4	1	D-48898
	(1/2)	(1-5/8)	(3-3/32)	(29/32)	1	D-50192
	(1/2)	(1-5/8)	(3-3/32)	(29/32)	1	D-50201
	(1/2)	(1-5/8)	(3-3/32)	(29/32)	1	D-70057

Tongue and groove bit



Range	Shank dia. mm(inch)	Overall dia. mm(inch)	Length mm(inch)	Carbide height mm(inch)	Sales pkg q'ty	Part No.
★★☆☆☆	12	41	38	6.35	1	D-12027
★★☆☆☆	12	41	71	19	1	D-48935
	12	41	71	19	1	D-68828
	(1/2)	(1-39/64)	(2-51/64)	(3/4)	1	D-50239
	(1/2)	(1-39/64)	(2-51/64)	(3/4)	1	D-70085

Router bit assortment



Range	Shank dia. mm(inch)	Note	Sales pkg q'ty	Part No.	
★★☆☆☆	6	-	12	A-87921	
	6	Straight bit 2 flute (6mm), Flush trim bit (12.7mm), Core box bit (12mm)	3	D-30209	
		8	-	12	A-88054
		(1/4)	-	3	D-30215
	(1/4)	-	12	A-91051	
★★☆☆☆	6	-	3	D-53338	
	6	-	3	D-70459	
	6	-	12	D-57065	
	8	-	4	D-53534	
	8	-	6	D-53540	
	8	-	12	D-53556	
	8	Grooving type	22	D-74784	
	8	Multipurpose type	22	D-74778	
	(1/4)	-	3	D-53344	
	(1/4)	-	3	D-70465	
	(1/4)	-	4	D-53562	
(1/4)	-	6	D-53578		
(1/4)	-	12	D-53584		

ACCESSORIES

Outdoor Power Equipment



Blade Nut, Cup, Clamp Washer, Grass Guard and Receive Washer



*** Receive Washer with Grass Guard

Cordless Brushcutter

Model No.	Spindle size		Receive washer			Blade clamp washer			Blade cup			Blade nut
			Arbor size (mm)	Size (mm)	Parts No.	Size (mm)	Arbor size (mm)	Parts No.	Size (mm)	Arbor size (mm)	Parts No.	Parts No.
DUR190L/U, DUR191L, DUR191U	M10x1.25LH	Rounded rectangle	25.4	---	***140T23-7	50	Rounded rectangle 12-10	347668-4	68	10.2	168526-9	264025-0
DUR365U, DUR366L, UR006G, UR007G	M10x1.25LH	Spline 10T	25.4	42	326518-6	50	10.2	346084-7	68	10.2	168526-9	264025-0
				---	***140L84-9							
DUR368A/L, UR002G, UR003G	M10x1.25LH	Spline 10T	25.4	---	***140L84-9	50	10.2	346084-7	68	10.2	168526-9	264025-0
DUR369A, DUR369L, UR101C, UR201C	M10x1.25LH	Spline 10T	25.4	64.5	144312-2	43	Spline 10T	347104-0	68	12	457274-8	252236-9
UR013G	M10x1.25LH	Spline 10T	25.4	64.5	140N88-3	43	Spline 10T	347766-4	68	12	413201-5	252236-9
UR016G, UR017G	M10x1.25LH	Spline 10T	25.4	50	140A87-7	43	Spline 10T	347766-4	68	12	413201-5	252236-9
UR012G	M10x1.25LH	Spline 10T	25.4	70.5	140J59-6	54.5	Spline 10T	162567-7	Integrated with Blade Clamp Washer			252236-9

Electric Brushcutter

Model No.	Spindle Size		Receive washer			Blade clamp washer			Blade cup			Blade nut
			Arbor size (mm)	Size (mm)	Parts No.	Size (mm)	Arbor size (mm)	Parts No.	Size (mm)	Arbor size (mm)	Parts No.	Parts No.
UR2300	M10x1.25LH	-	25.4	-	YA00000540	50	10.2	346084-7	68	10.2	168526-9	264025-0
UR3502	M10x1.25LH	-	-	-	YA00000540	-	-	-	-	-	-	-

Split shaft attachments

Model No.	Spindle Size		Receive washer			Blade clamp washer			Blade cup			Blade nut
			Arbor size (mm)	Size (mm)	Parts No.	Size (mm)	Arbor size (mm)	Parts No.	Size (mm)	Arbor size (mm)	Parts No.	Parts No.
EM400MP, EM402MP	M10x1.25LH	Spline 10T	25.4	60	326821-5	50	10.2	346084-7	68	10.2	168526-9	264025-0
EM401MP	M10x1.25LH	Spline 10T	25.4	60	331861-0 326821-5	50	10.2	346084-7	68	10.2	168526-9	264025-0
Old EM403MP, EM404MP	M10x1.25LH	Spline 10T	25.4	64.5	144312-2	43	10	347105-8	68	10	457290-0	252236-9
New EM403MP, EM404MP	M10x1.25LH	Spline 10T	25.4	64.5	144312-2	43	Spline 10T	347104-0	68	12	457274-8	
EM405MP, EM406MP	M10x1.25LH	Spline 10T	-	64.5	144312-2	-	-	-	-	-	-	252236-9
EM408MP	M10x1.25LH	Spline 10T	25.4	64.5	140N88-3	43	Spline 10T	347766-4	68	12	413201-5	252236-9
EM409MP	M10x1.25LH	Spline 10T	-	64.5	140N88-3	-	-	-	-	-	-	252236-9









Edger

Model No.	Spindle thread		Receive washer			Blade clamp washer		Blade nut
			Arbor size (mm)	Size (mm)	Parts No.	Size (mm)	Parts No.	Parts No.
EE400MP	M10x1.25LH	Spline 10T	25.4	54	326734-0	47	326381-7	264025-0

Cordless string trimmer

Model No.	Spindle size		Receive washer		Grass guard for receive washer
			Size (mm)	Parts No.	
DUR184L	M8x1.25RH	Spline 6T	36.5	326683-1	346857-8
DUR187L/U, DUR188L/U	M8x1.25LH	Rounded rectangle	36.5	144512-4	346857-8
DUR189	M8x1.25RH	Rounded rectangle	36.5	144512-4	346857-8
DUR192L	M10x1.25LH	-	71	140W47-1	
DUR364L	M8x1.25RH	Rounded rectangle	44	319245-2	346857-8
DUR366L	M10x1.25LH	Spline 10T	42	326518-6	346622-5
DUR369N, UR202C	M10x1.25LH	Spline 10T	65	140N88-3	
UR014G	M10x1.25LH	Spline 10T	65	327B76-7	





Blade selection guide

Blade type / Image		Short and soft grass			Tall and hard grass			Bush including tree beginning to grow				
Nylon cord		←————→										
Plastic blade		←————→										
Metal blade			←————→									
			←————→									
				←————→								
Brushcutter blade				←————→								
Shredder blade							←————→					
Chisel blade										←————→		



Brushcutter blades

Hole Dia.: 25.4mm
* Japanese Package

	Blade dia. / No. of teeth	Thickness	Model No.	Part No.
2-tooth blade				
	230mm / 2	2.0mm	DUR369A/L, UR006G, UR007G, UR016G, UR017G, UR101C, UR201C, EM400MP, EM401MP, EM402MP, EM403MP, EM404MP	197808-2 D-66058 197997-3(EU)
	255mm / 2	2.0mm	DUR369A DUR369L, UR006G, UR007G, UR101C, UR201C	198345-9 D-66064
	305mm / 2	2.0mm	UR012G	195624-6
4-tooth blade				
	230mm / 4	1.8mm	DUR190U/L, DUR191U/L, UR368A/L, DUR369A/L, UR002G, UR003G, UR006G, UR007G, UR016G, UR017G, UR101C, UR201C, EM400MP, EM401MP, EM402MP, EM403MP, EM404MP	195150-5 D-66008
	255mm / 4	2.0mm	DUR369A/L, UR006G, UR007G, UR016G, UR017G, UR101C, UR201C	196895-8 D-66014
8-tooth blade				
	200mm / 8	1.4mm	DUR194	191Y44-2
	230mm / 8	1.8mm	EM400MP, EM401MP, EM402MP, EM403MP, EM404MP	D-73324
3-tooth blade				
	230mm / 3	3.0mm	DUR190U/L, DUR191U/L, DUR368A/L, DUR369A/L, UR002G, UR003G, UR006G, UR007G, UR016G, UR017G, UR101C, UR201C, EM400MP, EM401MP, EM402MP, EM403MP, EM404MP	195298-3 D-66020
	255mm / 3	3.0mm	DUR369A, UR006G, UR007G, UR101C, UR201C	195299-1 D-66036
	305mm / 3	3.0mm	UR012G	195300-2 D-66042
Saw blade				
	230mm / 80	1.8mm	DUR368A, EM400MP, EM401MP, EM402MP, EM403MP, EM404MP	B-14152 D-73879
	255mm / 80	2.0mm	DUR369A	D-73885

Edger blade



Blade dia. / No. of teeth	Thickness	Model No.	Part No.
203mm / 2	2.5mm	EE400MP	196745-7





Special blade & Protection guard

Chisel blade





For brush and thin tree trunks and new growth. Not available in some countries due to local regulation

Model No.	Blade					Protection guard			
	Blade dia		Arbor size	Thickness	Part No.		Description	Pipe size	Part No.
UR012G	225mm		25.4mm	1.8mm	199872-9		Without protector clamp	28mm	199873-7
UR013G								25.4mm	1911Y0-3

Shredder blade

Model No.	Blade					Protection guard			
	Blade dia		Arbor size	Thickness	Part No.		Description	Pipe size	Part No.
UR012G	270mm		25.4mm	3.9mm	199874-5		Without protector clamp	28mm	199875-3
UR013G								25.4mm	1911Y1-1

Rotary scissors

Model No.	Blade				Protection guard			
	Blade dia			Part No.		Description	Pipe size	Part No.
EM407MP	230mm	A	B	A : SY00146013 B : SY00146014 A, B set : 191M75-9		Without protector clamp	24mm	412999-1

Plastic blade set



Model No.	Plastic blade set			Replacement plastic blade	
	Arbore size	Cutting width	Part No.	per pkg.	Part No.
UR100D	M8x1.25RH	230mm	198848-3	5	198850-6 / EU:198851-4
DUR194	M10x1.25LH	230mm	191Y45-0	12	198426-9
DUR187L/U, DUR188L, DUR190L/U, DUR191L/U, DUR188U, DUR189, DUR364L, DUR366L, DUR368A/L, DUR369A, DUR369L/N, UR001G, UR002G, UR003G, UR006G, UR007G, UR008G, UR016G, UR017G, UR101C, UR201C, UR202C, EM403MP, EM404MP, EM405MP, EM406MP	M8x1.25RH M8x1.25LH M10x1.25LH	255mm	198383-1	12	198426-9
DUR369A/L/N, UR101C, UR201C, UR202C, UR012G, UR013G	M10x1.25LH	305mm	199868-0	12	199870-3

String trimmer head

Quick loading Trimmer Head

(UN-74L, UN-72L, 96-M8L/R, 96-M10L, 121-M10L)

Nylon cord can be feeded without opening the head

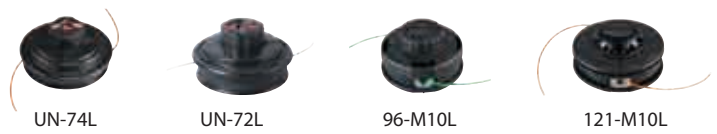

0 85(sec.)



0 35(sec.)

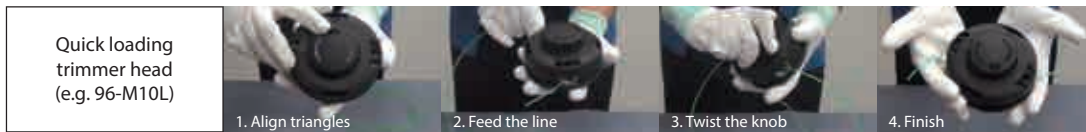



Up to 58% less feeding time!

String trimmer head

(for grass, light weeds)

* with adapter (Poly bag with header)

Description	Ref.	Size	Thread size	Cord/ Line	Model No.	Package	Part No.
Bump & Feed There is no need to ever split the trimmer head to replace or remove line. This head is simple to operate with reliability in performance.	UN-74L	4.4"	M10x1.25LH	2.4mm x 3.6m	DUR190L, DUR366L, DUR368A/L, DUR369A/L/N, UR002G, UR003G, UR016G, UR017G, UR101C, UR201C, UR202C, EM400MP, EM401MP, EM403MP, EM404MP, EM405MP, EM406MP	-	196324-1
	UN-72L/110-M10L	5"	M10x1.25LH	2.4mm x 6m	DUR369A, DUR369L, DUR369N, UR006G, UR007G, UR101C UR201C UR202C	Poly bag with header	198266-5
	121-M10L	5"	M10x1.25LH	2.4mm x 2m x2	UR012G	Carton box	191D93-3
				2.7mm x 2m x2	UR013G		1911Y2-9
			Spline 10T	2.7mm x 2m x2	UR014G		1911Y3-7
Bump & Feed		3"	M8x1.25RH	1.65mm x 8m	UR100D	Poly bag with header	198853-0 EU:198854-8
	95-M8R	4"	M8x1.25RH	2.0mm x 3m	DUR189	Poly bag with header	198972-2 EU:198971-4
	95-M8L	4"	M8x1.25LH	2.0mm x 3m	DUR187U/L, DUR188U/L, EM2500U/L, EM2600U/L	Poly bag with header	198386-5 EU:198385-7
	95-M10L	4"	M10x1.25LH	2.0mm x 3m	DUR190L/U, DUR191L/U, DUR192L, DUR365U, DUR366L, DUR368A/L, DUR369A/L/N, UR002G, UR003G, UR006G, UR007G, UR016G, UR017G, UR101C, UR201C, UR202C, EM400MP, EM401MP, EM403MP, EM404MP, EM405MP, EM406MP, EM408MP, EM409MP	Poly bag with header	198892-0 EU:198893-8
2.0mm x 3m				Clam shell case			US CA: 191R00-0
2.4mm x 3m				Poly bag with header			197804-0 EU:197993-1

Description	Ref.	Size	Thread size	Cord/ Line	Model No.	Package	Part No.
	Bump & Feed ECO 4R	4" Low profile	M8x1.25RH	2.0mm x 3m	DUR189	Poly bag with header	197297-1
	96-M8R	4"	M8x1.25RH	2.0mm x 4m	DUR189	Carton box	191D92-5 196871-2
	Bump & Feed ECO 4L	4" Low profile	M8x1.25LH	2.0mm x 3m	DUR187L	Poly bag with header	196589-5
	96-M8L	4"	M8x1.25LH	2.0mm x 4m	DUR187L	Carton box	191D91-7
	Bump & Feed ECO 4L	4" Low profile	M10x1.25LH	2.0mm x 3m	DUR192L, DUR368A/L, DUR369A/L/N, UR002G, UR003G, UR006G, UR007G, UR101C, UR201C, UR202C, EM408MP, EM409MP	Poly bag with header	197296-3
	96-M10L	4"	M10x1.25LH	2.0mm x 4m	DUR190L/U, DUR191L/U, DUR192L, DUR368A, DUR368L, DUR369A/L/N, UR002G, UR003G, UR006G, UR007G, UR016G, UR017G, UR101C, UR201C, UR202C, EM400MP, EM401MP, EM403MP, EM404MP, EM405MP, EM406MP, EM408MP, EM409MP	Carton box	191D89-4
				2.4mm x 3m	EM400MP, EM401MP, EM403MP, EM404MP, EM405MP, EM406MP	Blister pack	191R00-0
Bump & Feed Z5L / 105-M10L	5"	M10x1.25LH	2.4mm x 3m	EM400MP, EM401MP, EM403MP, EM404MP, EM405MP, EM406MP	Blister pack	B-05131	
			2.7mm x 3m	UR012G UR013G	Poly bag with header	199884-2	
	Ultra Auto 4L	4"	M8&10x1.25LH	2.4mm x 3m	DUR187U/L, DU188U/L, EM400MP, EM401MP, EM403MP, EM404MP, EM405MP, EM406MP	Carton box	*B-02945 *B-03006
			4"	M10x1.25LH	2.4mm x 3m	EM400MP, EM401MP, EM403MP, EM404MP, EM405MP, EM406MP	Blister pack
<p>Line will be feeded about 3cm, in either one of the following cases</p> <ul style="list-style-type: none"> -Head rotation are reached at 8,500rpm. -Bottom of the head is bumped on the ground when it is spinning. 							
<p>Eyelet 2pcs/set for Bump & Feed 4L/4R/Z5L, Ultra Auto 4R/4L/6L Part No. A-15992</p>							
	Manual	5"	-	2.4mm x 0.75m x 2	EM400MP, EM401MP, EM403MP, EM404MP, EM405MP, EM406MP	Carton box	B-02951







Spool assembly





Model No.	Part No.
UR3000	DA00000001
DUR181	195858-1
DUR193	191Y39-5

Shoulder strap assembly







*Poly bag with header

Type	Model No.	Part No.
	DUA250, DUA251, DUA300, DUA301, DUN500W DUN501W, DUR181, DUR184L, DUR187L, DUR188L, DUR189, DUR190L, DUR191L, DUR192L, DUR194, DUR368A/L, DUR369A/L, UA001G, UA002G, UA003G, UA004G; UR100D, DUX60,	125516-5
	DUR192L, DUR194, UR002G, UR003G; UR006G, UR007G, DUR193, DUR194, UX18D	127508-0
	DUR190L/U, DUR191U, DUR369A/L, UR006G, UR007G	125520-4
	DUR369A, UR002G, UR006G, UR007G	122906-3
	DUR368A DUR368U, DUR369A, DUR369U, UR002G, UR006G, UR007G, UR012G, UR013G, UR016G	122A37-4
	DUR369A, UR006G, UR007G, UR012G, UR013G	*199378-7

Line character

Shape	Sharpness	Energy Saving	Quietness
Round 		A	A
Square 	AA		
Four-leaf 	A	AA	AA

Color chart

Dia.	Color / Shape	Light duty		Heavy duty	
		Low density	High density	Low density	High density
1.3mm		↔			
1.6mm - 1.65mm		↔↔			
2.0mm			↔↔		
2.4mm			↔↔↔↔		
2.7mm				↔↔↔↔	
3.0mm					↔↔↔↔

Four-Leaf Line

Low noise and energy saving

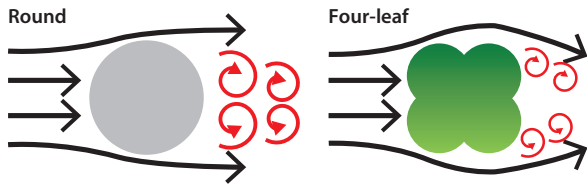

Four-leaf shape makes small vortex and realizes low noise and energy saving feature thanks to less air resistance.

The amount of cutting per 1 charge

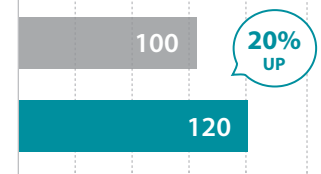



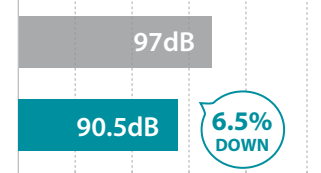

Noise



Standard Nylon cord

Color / Shape	Ring (mm)	dia. (mm)	length (m)	Part No.
	Single	1.3	15	E-02727
	Single	1.6	15	E-02733
	Single	2.0	15	E-02705
	Single	2.0	126	E-02711
	Single	2.4	15	E-02749
	Single	2.4	87	E-02761
	Single	2.4	262	E-02783
	Single	2.4	15	E-02808
	Single	2.4	69	E-02814
	Single	2.4	206	E-02820

Four-leaf Spiral Nylon cord

Color / Shape	Ring (mm)	dia. (mm)	length (m)	Part No.
	Single	1.65	15	E-01731
	Single	1.65	30	E-01747
	Single	1.65	445	E-01753
	Single	2.0	15	E-01769
	Single	2.0	30	E-01775
	Single	2.0	310	E-01781
	Single	2.4	15	E-01797
	Single	2.4	30	E-01806
	Single	2.4	225	E-01812
	Single	2.7	15	E-01828
	Single	2.7	30	E-01834
	Single	2.7	180	E-01840

Double-layer Nylon cord

Increased durability up to 130%* thanks to Flexible core coated with Impact & abrasion resistant skin
*compared to standard nylon cord

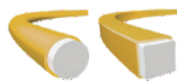

Color / Shape	Ring (mm)	dia. (mm)	length (m)	Part No.
	Single	3.0	15	E-02836
	Single	3.0	56	E-02842
	Single	3.0	168	E-02858
	Single	3.0	15	E-02870
	Single	3.0	44	E-02886
	Single	3.0	132	E-02892

Other Nylon cord (round, natural)



Size	Part No.
1.65mmx15m	DA00000003
2.4mmx5m	B-01971
3.0mmx4m	B-07375

String trimmer harness for PDC01 & PDC1200

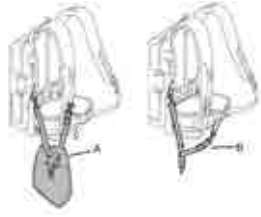

Item	Part No.
A	191E43-4
B	197243-4

Attachments for loop handle brushcutter Split shaft attachments

Model	item	Recommend power unit models
EM401MP	Brushcutter Cutting width : 300mm (String trimmer head) : 230mm (Brush cutter blade size) Spindle size : M10 x 1.25LH Arbor size : 25.4mm Gear ratio : 0.74 (14 : 19)	DUX60, UX01G
EM402MP	Brushcutter Blade size : 230mm (Brushcutter blades) Spindle size : M10 x 1.25LH Arbor size : 25.4mm Gear ratio : 0.74 (14 : 19)	DUX60
EM403MP	Brushcutter Cutting width : 450mm (String trimmer head) : 230mm (Brush cutter blade size) Spindle size : M10 x 1.25LH Arbor size : 25.4mm Gear ratio EM403MP : 0.74 (14 : 19) High speed type EM404MP : 0.62 (13 : 21) High torque & Low noise type	DUX60 UX01G
EM404MP		DUX60 with CE mark, UX01G with CE mark
EM405MP	Brushcutter (Narrow guard for String trimmer head) Cutting width : 450mm Spindle size : M10 x 1.25LH Gear ratio EM405MP : 0.74 (14 : 19) High speed type EM406MP : 0.62 (13 : 21) High torque & Low noise type	DUX60, EX2650LH, UX01G
EM406MP		DUX60 with CE mark, UX01G with CE mark,
EM407MF	Rotary scissors attach Set Cutting width : 230mm Stone & grass antiscattering brushcutter attachment.	DUX18, DUX60, UX01G
EM408MP	Brushcutter Cutting width : 300mm (String trimmer head) : 230mm (Brush cutter blade size) Spindle size : M10 x 1.25LH Arbor size : 25.4mm Gear ratio : 0.74 (14 : 19)	DUX18, DUX60, UX01G
EM409MP	Brushcutter (Narrow guard for String trimmer head) Cutting width : 300mm Spindle size : M10 x 1.25LH Gear ratio : 0.74 (14 : 19)	DUX18, DUX60, UX01G
EN424MP	Ground trimmer	DUX18, DUX60, UX01G
UB400MP	Blower *Except for European, Austrarian, Newzealand, Chinese & Korean markets .	DUX18, DUX60, UX01G
UB401MP	Blower	DUX18, DUX60, UX01G
UB402MP	Blower	DUX18, DUX60, UX01G
EY401MP	Pole saw Guide bar length : 25cm (10") Saw chain : 91VXL-39links	DUX18, DUX60, EX2650LH,
EY402MP	Pole saw Guide bar length : 25cm (10") Saw chain : 90PX-40links	DUX18, DUX60, EX2650LH,

Model	item	Recommend power unit models
EY403MP	Pole saw Guide bar length : 30cm (12") Saw chain : 90PX-46links or 91PX-46links Motor Mount : A041	DUX18, DUX60, UX01G
EN401MP	Pole hedge trimmer Angle adjustment	DUX18, DUX60, UX01G
EN402MP	Pole hedge trimmer	DUX18, DUX60, UX01G
EN410MP	Pole hedge trimmer Straight	DUX18, DUX60, UX01G
EN420MP	Ground trimmer	DUX18, DUX60, UX01G
EN422MP	Ground trimmer	DUX18, DUX60, UX01G
KR400MP	Cultivator Cultivating width : 160mm	DUX18, DUX60, UX01G
KR401MP	Cultivator Cultivating width : 220mm * Rotor LR set : P/N : 199204-0	DUX18, DUX60, UX01G
BR400MP	Power brush * Brush wheel (1pc) P/N : XNR0000548	DUX18, DUX60, UX01G
SW400MP	Power sweep * Sweeper wheel (1pc) : P/N : XNR0000549	DUX18, DUX60, UX01G
EJ400MP	Coffee harvester	DUX18, DUX60, UX01G
EE400MP	Edger attachment	DUX18, DUX60, UX01G
PF400MP	Pump Attachment Hose size (Inner diameter) : 25mm / 1" DUX18 : Max. lift height : 11 m Max, flow rate : 120 l/min DUX60 : Max. lift height : 14m Max, flow rate : 145 l/min UX01G : Max. lift height : 15 m Max, flow rate : 150 l/min	DUX18, DUX60, UX01G
E400MP	Shaft extension attachment (1.08m (42-1/2")) For Pole saw, Pole hedge trimmer and Coffee harvester	DUX18, DUX60, UX01G

Saw Chain and Guide Bar

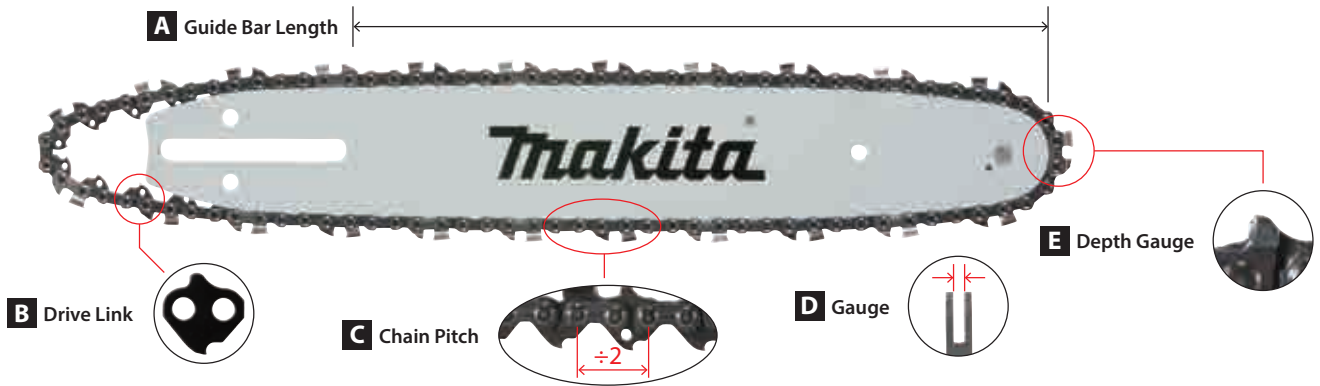

A Guide Bar Length
Guide bar's length is represented by cutting length, which is different from its whole length.



B Drive Link
The length of saw chain is determined by counting the number of drive links in the saw chain.

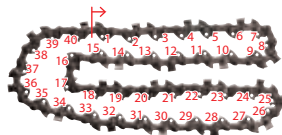

C Chain Pitch
Chain pitch is the size of the chain and it is defined by the distance between any three consecutive rivets divided by two. Pitch is important because the drive sprocket must be the same pitch as the chain.



D Gauge
Chain Gauge is thickness of drive link which will fit into the guide bar groove. Chain gauge must be the same as guide bar gauge.

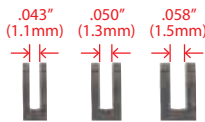

E Depth Gauge
Depth gauge determines how deep the cutting teeth gets into the wood. Cutting depth can be checked by the gap between top of cutter and depth gauge.



General Saw Chain Character

Chain Pitch	Gauge	Cutting speed			
		Fast	←	→	Slow
		.043" (1.1mm)	.050" (1.3mm)	.058" (1.5mm)	.063" (1.6mm)
Fine	1/4"		25AP		
	.325"LP	80TXL			
Surface condition	3/8"LP	90PX	91PX 91VXL		
	.325"		20BPX 95VPX	21BPX 21LPX	22LPX
Coarse	3/8"		72V	73DPX 73LGX 73LPX	
	.404"				27X

Guide Bar Type

Sprocket Nose Bars

Sprocket nose bars have a rotating sprocket mounted at the tip of the bar. As the chain moves along the bar, the sprocket teeth carry the chain around the tip smoothly with less friction.



High durability sprocket nose bar

Longer nose life thanks to larger nose sprocket than normal sprocket bars. Multiple rivets can be found on bar surface.



Solid Carving Bars

Carving bars are made of high-quality steel and high wear resistant stellite has been welded onto the tip. Bar tip is designed to have small radius for precision cutting. The carving bars are made for especially pruning and carving.



Guide Bar Maintenance

Chain Tension

Check the chain tension before use. The saw chain may become loose after many hours of use.



File Bar Edge

File bar edge with a flat file to keep it 90° once a week.



Clean Guide Bar

Clean out chips and sawdust every time when you sharpen or replace saw chain.



Bar Nose Grease

Lubricate a whole sprocket regularly so that the saw chain can rotate with less friction.



Chain Saws

Guide Bar / Saw Chain / Guide Bar Cover / Drive sprocket

Cutter type: CC: Chamfer chisel, SC: Semi chisel, MC : Micro chisel, FC: Full chisel

* Pole saw attachment (196315-2)

**without package

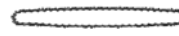

Model No.	Guide Bar					Saw Chain					Bar Cover	Drive sprocket	
	Bar length	Motor Mount	Type	Part No.	No. of drive links	Gauge	Pitch	Type OREGON	Cutter type	Part No. (Carton)	Part No.	Type	Part No.
Pole Saws													
EY401MP	25cm/10"	A218	Sprocket nose bar	191G11-9	39	1.3mm/.050"	3/8" LP	91VXL	SC	191H20-4	452093-7 / 458501-6	3/8"LP	XTM0000014
EY402MP EY403MP DUA250, DUA251 DUA300, DUA301 UA001G, UA002G UA003G, UA004G	25cm/10"	A041	Sprocket nose bar	191G14-3	40	1.1mm/.043"	3/8" LP	90PX	CC	191H00-0	452093-7 / 458501-6	3/8"LP	226992-7
	30cm/12"	A041		191G15-1	46	1.1mm/.043"				191H01-8	419288-5 / 413G23-5		
	25cm/10"	A041		191G22-4	40	1.3mm/.050"	91PX	CC	191H08-4	452093-7 / 458501-6			
	30cm/12"	A041		191G23-2	46				191H10-7	419288-5 / 413G23-5			
Cordless Chain Saws													
DUC101 UC100D	10cm/4"	—	without sprocket	1910W0-3	26	1.1mm/.043"	.325" LP	80TXL	MC	1910V6-4	413M40-1	.325"LP	227947-5
DUC121, DUC122	11.5cm/4-1/2"	—	without sprocket	158476-6	42	1.3mm/.050"	1/4"	25AP	MC	191G95-7	416311-7	1/4"	221527-9
DUC204 DUC254 DUC254C	25cm/10"	—	Solid carving bar	1911A1-3	60	1.3mm/.050"	1/4"	25AP	MC	191G96-5	452093-7 / 458501-6	1/4"	198259-2
	25cm/10"	A041	Sprocket nose bar	191T85-8	46	1.1mm/.043"	.325" LP	80TXL	MC	191T89-0	452093-7 / 458501-6	.325"LP	1911W6-9
	30cm/12"	A041		191T86-6	51	1.1mm/.043"				191T90-5	419288-5 / 413G23-5		
	20cm/8"	A041	Sprocket nose bar	191G13-5	33	1.1mm/.043"	3/8" LP	90PX	CC	191G99-9	458503-2	Sprocket 3/8"LP	199063-2
	25cm/10"	A041		191G14-3	40					191H00-0	452093-7 / 458501-6		
	30cm/12"	A041		191G15-1	46					191H01-8	419288-5 / 413G23-5		
25cm/10"	A041	191G22-4		40	191H08-4					419288-5 / 413G23-5			
30cm/12"	A041	Sprocket nose bar	191G23-2	46	1.3mm/.050"	3/8" LP	91PX	CC	191H08-4	452093-7 / 458501-6	Sprocket 3/8"LP	199063-2	
30cm/12"	A041	191G23-2	46	191H10-7	419288-5 / 413G23-5								
DUC252 DUC302 DUC352 DUC252C	25cm/10"	—	Solid carving bar	1911A1-3	60	1.3mm/.050"	1/4"	25AP	MC	191G96-5	452093-7 / 458501-6	Sprocket 1/4"	221528-7
	25cm/10"	A041	Sprocket nose bar	191G14-3	40	1.1mm/.043"	3/8" LP	90PX	CC	191H00-0	452093-7 / 458501-6	Sprocket 3/8"LP	221526-1
	30cm/12"	A041		191G15-1	46					191H01-8	419288-5 / 413G23-5		
	35cm/14"	A041	Sprocket nose bar	191G16-9	52	1.3mm/.050"	3/8" LP	91PX	CC	191H02-6	419288-5 / 413G23-5	Sprocket 3/8"LP	221526-1
	25cm/10"	A041		191G22-4	40					191H08-4	452093-7 / 458501-6		
	30cm/12"	A041		191G23-2	46					191H10-7	419288-5 / 413G23-5		
35cm/14"	A041	191G24-0		52	191H11-5					419288-5 / 413G23-5			
DUC256 DUC306 DUC356 DUC406 DUC256C	25cm/10"	—	Solid carving bar	191G61-4	60	1.3mm/.050"	1/4"	25AP	MC	191G96-5	452093-7 / 458501-6	Sprocket 1/4"	198259-2
	25cm/10"	A041	Sprocket nose bar	191T85-8	46	1.1mm/.043"	.325" LP	80TXL	MC	191T89-0	452093-7 / 458501-6	Sprocket .325"LP	1911W6-9
	30cm/12"	A041		191T86-6	51					191T90-5	419288-5 / 413G23-5		
	35cm/14"	A041	Sprocket nose bar	191T87-4	59	1.1mm/.043"	3/8" LP	90PX	CC	191T91-3	419288-5 / 413G23-5	Sprocket 3/8"LP	199063-2
	25cm/10"	A041		191G14-3	40					191H00-0	452093-7 / 458501-6		
	30cm/12"	A041		191G15-1	46					191H01-8	419288-5 / 413G23-5		
	35cm/14"	A041		191G16-9	52					191H02-6	419288-5 / 413G23-5		
	40cm/16"	A041	Sprocket nose bar	191G17-7	56	1.3mm/.050"	3/8" LP	91PX	CC	191H03-4	419242-9 / 413G21-9	Sprocket 3/8"LP	199063-2
	25cm/10"	A041		191G22-4	40					191H08-4	452093-7 / 458501-6		
	30cm/12"	A041		191G23-2	46					191H10-7	419288-5 / 413G23-5		
35cm/14"	A041	191G24-0		52	191H11-5					419288-5 / 413G23-5			
40cm/16"	A041	191G25-8		56	191H12-3					419242-9 / 413G21-9			
40cm/16"	A041	Sprocket nose bar		191G15-1	46					1.1mm/.043"	3/8" LP		
35cm/14"	A041		191G16-9	52	191H02-6	419288-5 / 413G23-5							
DUC307 DUC357 DUC407	40cm/16"	A041	Sprocket nose bar	191G17-7	56	1.3mm/.050"	3/8" LP	91PX	CC	191H03-4	419242-9 / 413G21-9	Sprocket 3/8"LP	199063-2
	30cm/12"	A041		191G23-2	46					191H10-7	419288-5 / 413G23-5		
	35cm/14"	A041	Sprocket nose bar	191G24-0	52					191H11-5	419288-5 / 413G23-5		
	40cm/16"	A041		191G25-8	56					191H12-3	419242-9 / 413G21-9		
DUC303 DUC400 DUC305 DUC355 DUC405	25cm/10"	—	Solid carving bar	1911A1-3	60	1.3mm/.050"	1/4"	25AP	MC	191G96-5	452093-7 / 458501-6	Sprocket 1/4"	198259-2
	30cm/12"	A041	Sprocket nose bar	191T86-6	51	1.1mm/.043"	.325" LP	80TXL	MC	191T90-5	419288-5 / 413G23-5	Sprocket .325"LP	1911W6-9
	35cm/14"	A041		191T87-4	59					191T91-3	419288-5 / 413G23-5		
	40cm/16"	A041	Sprocket nose bar	191T88-2	64	1.1mm/.043"	3/8" LP	90PX	CC	191T92-1	419242-9 / 413G21-9	Sprocket 3/8"LP	199063-2
	30cm/12"	A041		191G15-1	46					191H01-8	419288-5 / 413G23-5		
	35cm/14"	A041		191G16-9	52					191H02-6	419288-5 / 413G23-5		
	40cm/16"	A041		191G17-7	56					191H03-4	419242-9 / 413G21-9		
	30cm/12"	A041	Sprocket nose bar	191G23-2	46	1.3mm/.050"	3/8" LP	91PX	CC	191H10-7	419288-5 / 413G23-5	Sprocket 3/8"LP	199063-2
	35cm/14"	A041		191G24-0	52					191H11-5	419288-5 / 413G23-5		
	40cm/16"	A041		191G25-8	56					191H12-3	419242-9 / 413G21-9		
40cm/16"	A041	191G25-8		56	191H12-3					419242-9 / 413G21-9			

Model No.	Guide Bar					Saw Chain					Bar Cover	Drive sprocket	
	Bar length	Motor Mount	Type	Part No.	No. of drive links	Gauge	Pitch	Type OREGON	Cutter type	Part No. (Carton)	Part No.	Type	Part No.
UC002G UC003G UC004G UC006G UC007G	25cm/10"	—	Solid carving bar	1911A1-3	60	1.3mm/.050"	1/4"	25AP	MC	191G96-5	452093-7 / 458501-6	Sprocket 1/4"	191V92-3
	25cm/10"	A041	Sprocket nose bar	191T85-8	46	1.1mm/.043"	.325" LP	80TXL	MC	191T89-0	452093-7 / 458501-6	Sprocket .325"LP	191V91-5
	30cm/12"	A041		191T86-6	51					191T90-5	419288-5 / 413G23-5		
	35cm/14"	A041		191T87-4	59					191T91-3	419288-5 / 413G23-5		
	25cm/10"	A041	Sprocket nose bar	191G14-3	40	1.1mm/.043"	3/8" LP	90PX	CC	191H00-0	452093-7 / 458501-6	Sprocket 3/8"LP	191V90-7
	30cm/12"	A041		191G15-1	46					191H01-8	419288-5 / 413G23-5		
	35cm/14"	A041		191G16-9	52					191H02-6	419288-5 / 413G23-5		
	25cm/10"	A041	Sprocket nose bar	191G22-4	40	1.3mm/.050"	3/8" LP	91PX	CC	191H08-4	452093-7 / 458501-6	Sprocket 3/8"LP	191V90-7
	30cm/12"	A041		191G23-2	46					191H10-7	419288-5 / 413G23-5		
35cm/14"	A041	191G24-0		52	191H11-5					419288-5 / 413G23-5			
UC010G UC011G UC012G UC013G UC014G UC015G UC016G UC017G UC020G	30cm/12"	A041	Sprocket nose bar	191T86-6	51	1.1mm/.043"	.325" LP	80TXL	MC	191T90-5	419288-5 / 413G23-5	Sprocket .325"LP	191V91-5
	35cm/14"	A041		191T87-4	59					191T91-3	419288-5 / 413G23-5		
	40cm/16"	A041		191T88-2	64					191T92-1	419242-9 / 413G21-9		
	45cm/18"	A041	Sprocket nose bar	191X03-0	70	1.1mm/.043"	3/8" LP	90PX	CC	191X04-8	419242-9 / 413G21-9	Sprocket 3/8"LP	191V90-7
	30cm/12"	A041		191G15-1	46					191H01-8	419288-5 / 413G23-5		
	35cm/14"	A041		191G16-9	52					191H02-6	419288-5 / 413G23-5		
	40cm/16"	A041	Sprocket nose bar	191G17-7	56	1.3mm/.050"	3/8" LP	91PX	CC	191H03-4	419242-9 / 413G21-9	Sprocket 3/8"LP	191V90-7
	30cm/12"	A041		191G23-2	46					191H10-7	419288-5 / 413G23-5		
	35cm/14"	A041		191G24-0	52					191H11-5	419288-5 / 413G23-5		
	40cm/16"	A041	Sprocket nose bar	191G25-8	56	1.3mm/.050"	3/8" LP	91PX	CC	191H12-3	419242-9 / 413G21-9	Sprocket 3/8"LP	191V90-7
	45cm/18"	A041		191G26-6	62					191H13-1	419242-9 / 413G21-9		

Electric Chain Saws

UC3041A, UC3541A, UC4041A	30cm/12"	A041	Sprocket nose bar	191G15-1	46	1.1mm/.043"	3/8" LP	90PX	CC	191H01-8	419288-5 / 413G23-5	Sprocket 3/8"LP	221526-1
	35cm/14"	A041		191G16-9	52					191H02-6	419288-5 / 413G23-5		
	40cm/16"	A041		191G17-7	56					191H03-4	419242-9 / 413G21-9		
	30cm/12"	A041	Sprocket nose bar	191G23-2	46	1.3mm/.050"	3/8" LP	91PX	CC	191H10-7	419288-5 / 413G23-5	Sprocket 3/8"LP	221521-1
	35cm/14"	A041		191G24-0	52					191H11-5	419288-5 / 413G23-5		
	40cm/16"	A041		191G25-8	56					191H12-3	419242-9 / 413G21-9		
UC3050A, UC3550A, UC4050A, UC4550A, UC3051A, UC3551A, UC4051A, UC4551A	30cm/12"	A041	Sprocket nose bar	191G23-2	46	1.3mm/.050"	3/8" LP	91PX	CC	191H10-7	419288-5 / 413G23-5	Sprocket 3/8"LP	221521-1
	35cm/14"	A041		191G24-0	52					191H11-5	419288-5 / 413G23-5		
	40cm/16"	A041		191G25-8	56					191H12-3	419242-9 / 413G21-9		
	45cm/18"	A041		191G26-6	62					191H13-1	419242-9 / 413G21-9		

Solid carving bar

Part No. 1911A1-3



Saw Chain: 25AP-60 links

Part No. 191G96-5



Drive sprocket: 1/4" 9T

Model No.

DUC204, DUC254, DUC254C, DUC303, DUC353, DUC400, DUC305, DUC355, DUC405













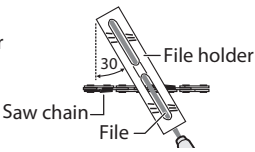

DUC256, DUC306, DUC356, DUC406, DUC256C: 198259-2

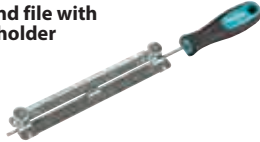
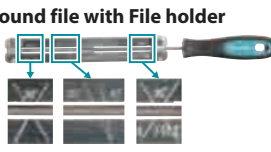
DUC252, DUC302, DUC352, DUC252C: 221528-7

UC002G, UC003G, UC004G, UC006G, UC007G: 191V92-3



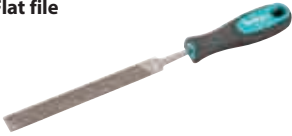

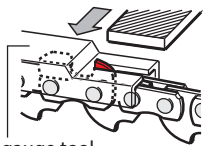
Sharpening Saw Chain

<How to Sharpening Saw Chain>	<Using accessory>
<p>1. To sharpen Cutting Corner & Side Plate</p> <p>To sharpen Cutting corner & Side plate, use Round file.</p> <div style="display: flex; justify-content: space-around;"> <div style="text-align: center;">  <p>Cutting corner</p> </div> <div style="text-align: center;">  <p>Side plate</p> </div> <div style="text-align: center;">  </div> </div> <p>When use a file, try to keep 1/5 of the Round file diameter appeared from the saw chain.</p> <p>With a File holder, it is easy to keep 1/5 file diameter appeared.</p> <div style="text-align: center;">  </div> <p>There are appropriate angles to use a file, according to a Saw Chain type. File holder or Angle plate are used to see the appropriate angle.</p> <div style="text-align: center;">  </div> <p>If you have to sharpen Saw Chain outdoors where it is difficult to secure your Chain Saw, drive the Filing vise into the wood and you can use a file anywhere.</p>	<div style="display: flex; justify-content: space-around;"> <div style="text-align: center;">  <p>Round file</p> </div> <div style="text-align: center;">  <p>Round file bit (for power tool)</p> </div> </div> <div style="text-align: center; margin-top: 20px;">  <p>Round file with File holder</p> </div> <div style="display: flex; justify-content: space-around; margin-top: 20px;"> <div style="text-align: center;">  <p>Round file with File holder</p> </div> <div style="text-align: center;">  <p>Angle Plate</p> </div> <div style="text-align: center;">  </div> </div> <div style="display: flex; justify-content: space-around; margin-top: 20px;"> <div style="text-align: center;">  <p>Filing vise</p> </div> <div style="text-align: center;">  </div> </div>
<p>2. To grind Depth gauge</p> <p>Use a Flat file to adjust Depth Gauge height.</p> <div style="text-align: center;">  </div> <p>Depth gauge tool is to see adjustment necessity and how much to grind off Depth Gauge. Put on Depth gauge tool on Depth Gauge and grind off Depth Gauge's exposed part with a Flat file.</p>	<div style="text-align: center; margin-bottom: 20px;">  <p>Flat file</p> </div> <div style="text-align: center;">  <p>Depth gauge tool</p> </div> <div style="text-align: right; margin-top: 10px;">  <p>Depth gauge tool</p> </div>

Diameter and sharpening angle of Round file

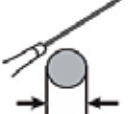
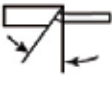

	DOLMAR No.			
25AP	466	4.0mm / 5/32"	30°	0.65mm / .025"
80TXL	-	4.0mm / 5/32"	30°	0.65mm / .025"
90PX	291	4.5mm / 11/64"	30°	0.65mm / .025"
91PX	492	4.0mm / 5/32"	30°	0.65mm / .025"
91VXL	196			
95VPX	484	4.8mm / 3/16"	30°	0.65mm / .025"
20BPX	082	4.8mm / 3/16"	30°	0.65mm / .025"
21BPX	086			
21LPX	686	4.8mm / 3/16"	25°	0.65mm / .025"
72V	496	5.5mm / 7/32"	25°	0.65mm / .025"
73DPX	093	5.5mm / 7/32"	30°	0.65mm / .025"
73LPX	099	5.5mm / 7/32"	25°	0.65mm / .025"
27X	103	5.5mm / 7/32"	30°	0.75mm / .030"

Bar cover

Item	size (mm)	size (inch)	Part No.
	125	5"	413M40-1
	210x90	8-1/4" x 3-1/2"	458503-2
	280x90	11" x 3-1/2"	458501-6
	280x90	11" x 3-1/2"	452093-7
	360x10	14-1/8" x 4"	419288-5
	360x10	14-1/8" x 4"	413G23-5
	460x10	18-1/8" x 4"	419242-9 /
	460x10	18-1/8" x 4"	413G21-9

File and File holder

For Model:
Chain saw



*with gurip

Saw chain type	File			File and File holder
	Size	Q'ty	Part No.	Part No.
25F, 25AP, 80TXL, 91P, 91PX, 91PXL, 91VXL	4mm 5/32"	1	*744003-1	-
		1	953003090	195089-2
		2	D-67359	953030010
		12	D-67365	D-70948
90PX, 90SG	4.5mm 11/64"	1	953003100	195923-6
		2	D-67371	953030020
		12	D-67387	D-70954
95VPX/ TXL, 20BPX/ LPX/ , 21BPX/ LPX, 22BPX/ LPX, 082, 086, 686, 484	4.8mm 3/16"	1	953003070	197712-5
		2	D-67393	953030030
		12	D-67402	D-70976
72DPX/ LPX, 73DPX/ LPX, 75DPX/ LPX	5.2mm 13/64"	2	D-67418	D-70976
		12	D-67424	
72DPX/ LPX/ APX/ EXL/ EXJ/ LGX/ JGX/ JPX/ RD V, 73DPX/ LPX/ EXL/ EXJ/ LGX/ JGX/ JPX/ RD V, 75DPX/ LPX/ EXL/ EXJ/ LGX/ JGX/ JPX/ RD V, 496, 093, 099	5.5mm 7/32"	1	953003040	953009000 D-70982
		2	D-67430	
		12	D-67446	

Round file bit

For all saw chain



Description	Size	Part No.
Round File bit 6.35mm (1/4") Hex shank (MZ)	φ4.0mm (5/32")	D-73748
	φ4.5mm (11/64")	D-73754
	φ4.8mm (3/16")	D-73760
	φ5.2mm (13/64")	D-73776
	φ5.5mm (7/32")	D-73782

Angle Plate / Angle Plate & Diamond File bit set

For all saw chain



Description	Diamond File Size	Part No.
Angle Plate (25 / 30deg.)	-	D-75605
Angle Plate & Diamond File bit 1/4"Hex shank (MZ) set	φ4.0mm (5/32")	D-75611
	φ4.5mm (11/64")	D-75627
	φ4.8mm (3/16")	D-75633
	φ5.2mm (13/64")	D-75649
	φ5.5mm (7/32")	D-75655

Flat File, Depth gauge

For all saw chain
Depth gauge : .025" / 0.64mm

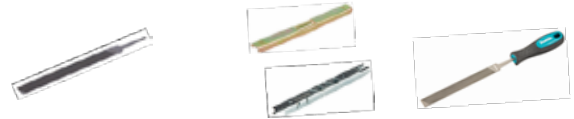

Flat file		Depth gauge	Flat file and File handle and Depth gauge
Part No.	Q'ty	Part No.	Part No.
953003060	1	953100090	-
D-67452	1	D-67474	D-70998
D-67468	12		

File set for in Roll Up Pouch

For all saw chain



Description	Part No.
φ4.0mm Round File(3pcs) / File Holder / Flat File / Handle(2pcs) / Depth Gauge	D-72154
φ4.5mm Round File(3pcs) / File Holder / Flat File / Handle(2pcs) / Depth Gauge	D-72160
φ4.8mm Round File(3pcs) / File Holder / Flat File / Handle(2pcs) / Depth Gauge	D-72176
φ5.2mm Round File(3pcs) / File Holder / Flat File / Handle(2pcs) / Depth Gauge	D-72182
φ5.5mm Round File(3pcs) / File Holder / Flat File / Handle(2pcs) / Depth Gauge	D-72198

File handle





Q'ty	Part No.
1	953004010
1	D-67496
50	D-67505

Filling vise



Part No.
D-67480

Chain oil

Item		Size	Part No.
 <p>Chain oil</p> <p>With Makita chain oil, chain oiling is formulated to adhere to the bar and chain and to reduce wear.</p> <p>Adhesion additive helps keep sap and pitch from clinging to the bar and chain. (Not available in Austria)</p>		100 ml	182229-1 199897-3
		1L	195093-1 988002656
		5L	988002658
		55L	988002260
		200L	988002261
 <p>BIOTOP Chain oil</p> <p>With BIOTOP, chain oiling is safe for environment. BIOTOP is purely vegetable-based and readily biodegradable. It meets the strict requirements of the RAL UZ48 environment mark for environmental compatibility, lubrication, and aging resistance.</p>		1L	980008610

Pruning extension set

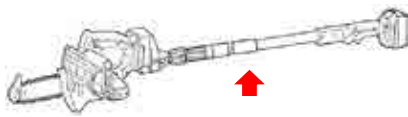

Model No.	Part No.
DUC122	195595-7

Holster for DUC101 & UC100D

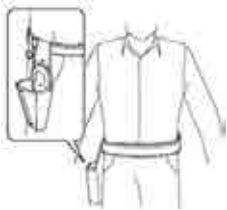

Model No.	Part No.
DUC101 UC100D	1911R0-4

Angled attachment set for Pole saw



Model No.	Part No.
UA001G, UA002G, UA003G, UA004G, DUA250, DUA251, DUA300, DUA301	1910J6-0

Hook holder for extension cord



Type	Description	Part No.
A	Arm band complete set	194679-8
B	Cord holder complete set	194677-2
C	Hook complete	158024-1

Shear blade & Blade cover for Grass Shear

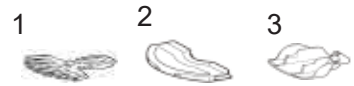

Model No.	Cutting width	1	2	3
		Blade assembly	Blade cover	Grass Receiver
DUM168, DUM604, UM600D, UM603D	160mm	195267-4	452055-5	457426-1
DUM111 UM110D	110mm	191N23-4	459011-6	454880-0

Conversion from Hedge Trimmer to Grass Shear

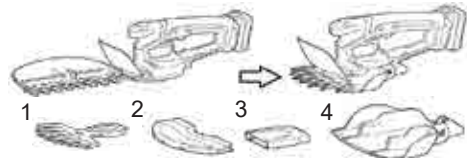

Model No.	Cutting width	1	2, 3 & 4	3
		Blade assembly	Blade cover, Grass receiver & Clank cover set	Clank cover
UH201D	160mm	195267-4	198412-0	452198-3
	110mm	191N23-4	191N25-0	

Shear blade & Blade cover for Grass Shear Hedge Trimmer



Model No.	1		2	3
	Blade assembly	Surface treat	Blade cover	Chip receiver
UH201D	198408-1	NICKEL PLATING	458342-0	198401-5

Conversion from Grass Shear to Hedge Trimmer

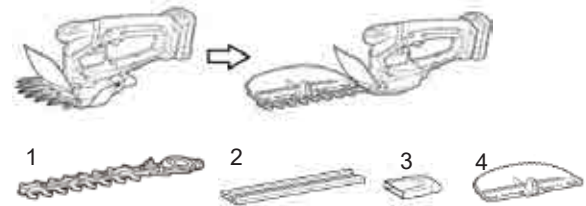

Model No.	1		2	2 & 3	4
	Blade assembly	Surface treat	Blade cover	Blade cover set	Chip receiver
UM110D, DUM111	191N24-2	BLACK OXIDE	458342-0	195274-7	198401-5
UM110D, DUM111 DUM604, UM600D, UM603D	198408-1	NICKEL PLATING	458342-0	195274-7	198401-5

Long attachment handle (Extension handle kit)

*with grass shear blade



Model No.	Part No.
DUM604, *DUH202, UM110D, DUM111, UM600D, UM603D, *UH201D	198516-8

Shear blade, Blade guard, End guard, Blade cover & Chip receiver for Hedge Trimmer

*Attached to blade assembly or blade set

** With screw & wrench

***With screw, wrench & blade cover

****For Blade without end cover

*****For Blade with end cover

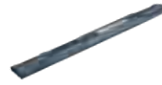

Cordless Hedge Trimmer

Model No.	Blade size	Blade assembly		Blade guard	End guard (End cover / Tip guard / Branch catcher)	Blade cover	Chip receiver		Grease
		Part No.	Description				Part No.	Description	
UH201D, DUH202	200mm	198408-1	---	---	---	451816-0 458342-0	198401-5		*No.1
DUH551	550mm	194671-4 EU:196687-5	With End guard	---	*345205-8	450489-6	194681-1	One-touch installation / removal	*No.2
DUH651	650mm	194673-0 EU:196688-3		---	*345205-8	450490-1	194681-1		*No.2
DUH506	500mm	1910H8-2	---	Built in the Blade	---	413L91-8	1910T1-0	One-touch installation / removal	*No.2
DUH606	600mm	1910H9-0	---		---	413L92-6	1910T2-8		*No.2
DUH507	500mm	1911J1-6	---		---	413L91-8	1910T1-0		*No.2
DUH607	600mm	1911J2-4	---		---	413L92-6	1910T2-8		*No.2
DUH501	500mm	191T44-2	With Blade guard, with End guard	*412908-0	*345205-8	412910-3	191W56-3	One-touch installation / removal	*No.2
DUH601	600mm	191R53-9				412911-1	191R51-3		*No.2
DUH751	750mm	191R54-7				412912-9	191R52-1		*No.2
DUH502	500mm	191T47-6	With Blade guard, with End guard	*412908-0	*345205-8	459120-1	191W56-3	One-touch installation / removal	*No.2
DUH602	600mm	191R57-1				459121-9	191R51-3		*No.2
DUH752	750mm	191R58-9				459122-7	191R52-1		*No.2
DUH504S	500mm	A-70459	Without Blade guard, without End guard, Japanese package	---	---	412768-0	191D33-1	Without bind head screw M5X12 (P/N: 915211-3 4pics)	*No.2
DUH604S	600mm	191Y03-6	With Blade guard, without End guard	*347962-4	---	412769-8	191D33-1	Without bind head screw M5X12 (P/N: 915211-3 4pics)	*No.2
DUH754S	750mm	191Y05-2		*347962-4	---	412770-3	191D34-9	Without bind head screw M5X12 (P/N: 915211-3 5pics)	*No.2
UH004G	600mm	191R53-9	With Blade guard, with End guard	*412908-0	*345205-8	412911-1	191R51-3	One-touch installation / removal	*No.2
UH005G	750mm	191R54-7				412912-9	191R52-1		*No.2
UH006G	600mm	191R55-5				412911-1	191R51-3		*No.2
UH007G	750mm	191R56-3				*413794-2	*---		412912-9
UH008G	600mm	191R57-1	With Blade guard, with End guard	*412908-0	*345205-8	459121-9	191R51-3	One-touch installation / removal	*No.2
UH009G	750mm	191R58-9				459122-7	191R52-1		*No.2
UH013G	600mm	191Y03-6	With Blade guard, with End guard	*347962-4	---	413B98-4	191D33-1	Without bind head screw M5X12 (P/N:915211-3 4pics)	*No.2
UH014G	750mm	191Y05-2				413B99-2	191D34-9	Without bind head screw M5X12 (P/N:915211-3 5pics)	*No.2

Electric Hedge Trimmer

Model No.	Blade size	Blade assembly		Blade guard	End guard (End cover / Tip guard / Branch catcher)	Blade cover	Chip receiver		Grease
		Part No.	Description				Part No.	Description	
UH4261	420mm	140826-9	---	Built in the blade	---	452683-6	195050-9	One-touch installation / removal	No.2
UH4861	480mm	140830-8	---		---	452684-4	195050-9		No.2
UH5261	520mm	140827-7	---		---	452685-2	195050-9		No.2
UH4570	450mm	194660-9	With end guard	Built in the blade	*345205-8	450489-6	194681-1	One-touch installation / removal	*No.2
UH5570	550mm	194663-3				450489-6			*No.2
UH6570	650mm	194666-7				450490-1			*No.2
UH5580	550mm	194671-4 EU:196687-5	With end guard	Built in the blade	*345205-8	450489-6	194681-1	One-touch installation / removal	*No.2
UH6580	650mm	194673-0 EU:196688-3				450490-1			*No.2
UH7580	750mm	194675-6				450490-1			*No.2

Cordless Pole Hedge Trimmer

*Attached to Blade assembly

Model No.	Blade size	Blade assembly		Blade guard	End guard (End cover / Tip guard / Branch catcher)	Blade cover	Chip receiver		Grease
		Part No.	Description	Part No.	Part No.	Part No.	Part No.	Description	
DUN461W UN460WD	460mm	191P00-8	Without Blade guard	---	---	413720-1	191T43-4	One-touch installation / removal	*No.1
DUN500W	500mm	191C14-9		---	*345205-8	458413-3	1910M5-3		*No.2
DUN501W	500mm	191E73-5		---		459120-1			*No.2
DUN600L	600mm	191C13-1		---		458414-1			1910M-1

Model No.	Blade size	Item	Part No.	Part name	Item	
EN401MP EN410MP	500mm 490mm	12	196263-5 196264-3	Blade cover & End cover set		
		13	196969-5	End cover set		
		1-11 set	198049-3	Shear blade assembly set M		
		1-11, 13 set	197763-8 197768-8	Shear blade assembly set MG Shear blade assembly set ME		
EN401MP	490mm	---	---	No.1		
		Grease	197439-7	Grease vessel set		No.0 80g
			191E22-2	Grease vessel set (for russia)		
		7, 8	725187-4	Shear blade		
EN420MP	250mm	12		Blade cover		
		7 8	725197-1	Shear blade		
		12	458345-4	Blade cover		
		1-11	198195-2	Shear blade assembly set mg		
EN402MP	500mm	Grease	---	No.1		
		1	1912G3-7	Shear blade 500 set		
		2	413R17-6	Blade cover 500		
EN422MP	250mm	Grease	---	*No.2		
		1	1912G2-9	Shear blade 250 set		
		2	413P96-2	Blade cover 250		

Grease vessel set

Description	Size		Part No.
For Pole hedge trimmer and Multi-tool attachments (Cultivator, Power brush and Power sweep) (GREASE NO.0)	80ml		197439-7
	80ml	For RUSSIA	191E22-2
For string trimmer, Brushcutter and Hedge trimmer (GREASE NO.2)	80ml		199450-5
	80ml	For RUSSIA	199456-3

Pruning Shear blade

Shear blade (U)

Shear blade (L)

Do not re-use Stop Ring E-4 when reassembling.
Stop Ring E-4



*With Stop Ring E-4 (P/N:961011-9)

**Hex socket button head screw M3x6 P/N:266183-8 & Shoulder bolt M8 P/N:251573-8 are also necessary.

Model No.	Type	*Shear blade (U)	Shear blade (L)
		Part No.	Part No.
DUP361 DUP362	Standard	197748-4 EU : 197588-0*	197749-2 EU : 197367-6
	For hard branch	199168-8	199169-6
	For thin branch	199314-3**	199171-9**
UP100D	Standard	1911W2-5	1911W1-7

Branch catcher set for thin branch

Branch catcher set



Model No.	Part No.
*DUP361, *DUP362	199311-9

Diamond file for shear blade & Dresser stone set



	Model No.	Model No.	Part No.
	Diamond file	DUP361, DUP362	794530-8
	Dresser stone set	UP100D	1912E4-1

Battery powered pruning shear others accessory



Model No.	Item	Part No.
DUP361 DUP362	Standard Harness	161377-9
	Narrow Strap Harness for Summer	161603-6
	Holster	161379-5
	Arm Band	166062-9
	Cord Holder	154511-8
	Connection Cord	661445-3
UP100D	Holster	162C23-5

Wheelbarrow attachment

Model No.	Item	Part No.
DCU180		Carrier set (Pipe deck) 199116-7 EU: 199009-8
		Bucket set 198494-2 EU: 199008-0
		Auxiliary wheel attachment set 191A01-6
DCU603 DCU604 DCU605		Dump bucket 200 set 191B69-8
		Dump unit set 191B63-0
		Carrier set 191B67-2
		Dump unit set 191B63-0
		Flat bucket set 1911B3-6

Optional Tire & wheel set for Wheelbarrow



Model No.	Item	Color	Part No.
DCU603 DCU604 DCU605	Tire 330 (single) set for pavement or concrete floor (Tire (13x5.00-6), tube & Divided type rim set)	Black	1911K4-7
	Gray tire 330 (single) set for painted floor (Tire (13x5.00-6), Tube & Divided type rim)	Gray	1911K5-5
	Gray tire 210 (single) set for painted floor (Tire (2.00-4), Tube & Divided type rim with hub bearing set)	Gray tire leaves less tire mark on painted floor compared with black one.	1911K6-3

Backpack Mist Blower

Model No.	Items	Part No.
PM001G	Deflector set	198248-7 (EU)198249-5
PM001G	Sternum strap	196733-4

Rotary lawn mower blade



*High flow blade for better grass catching
**Mulching blade used without grass catcher

Model No.	Size(mm)	Part No.
Cordless Lawn Mower		
DLM382	380	191D41-2
DLM432	430	191D43-8
DML460, DLM461, DLM463, DLM464	460	199367-2
DML460, DLM461, DLM463, DLM464	460	*1910N1-8
DLM462, DLM465	460	*191W86-4
DLM462, DLM465	460	191D51-9
DLM462, DLM465	460	191Y63-8
DLM480, DLM481, LM001G, LM001J, LM003J	480	191V97-3
DLM480, DLM481, LM001G, LM001J, LM003J	480	**191Y64-6
DLM530, DLM531, DLM532, DLM533, DLM534, DLM535, DLM536, DLM537, LM001C	530	191D52-7
DLM538, DLM539, LM002G, LM002J, LM004J	530	191V96-5
DLM530, DLM532, DLM533, DLM534, DLM536, DLM538, DLM539, LM001C, LM002G, LM002J, LM004J	530	*191W87-2
DLM530, DLM531, DLM532, DLM533, DLM534, DLM535, DLM536, DLM537, DLM538, DLM539, LM001C, LM002G, LM002J, LM004J	530	**191Y65-4
Electric Lawn Mower		
LM2301	230	191Y46-8
ELM3320	330	YA00000745
ELM3720	370	YA00000746
ELM4120	410	YA00000747
ELM4121	410	YA00000738
ELM4620	460	YA00000741
ELM4621	460	YA00000741

Rotary lawn mower swing back blade



Model No.	Swing back blade set		Replacement blade set	
	Size(mm)	Part No.	Par pkg.	Part No.
DLM462, DLM465	460	191D49-6	4	191D47-0
LM001G, LM003J	480	1911B0-2	4	1911P1-8
DLM530, DLM531, DLM532, DLM533, DLM534, DLM535, DLM536, DLM537, LM001C, LM002G, LM004J	530	191D50-1	4	191D48-8

Mulching plug set

Model No.	Part No.
DLM382 DLM432	191D46-2

Scarifier drum

Model No.	Item	Part No.
UV3200		Scarifying 652024718
		Lawn Raking 652024719
UV3600		Scarifying 652024746
		Combination 652024750
		Lawn Raking 652024749

Earth auger handle set for Angle drill

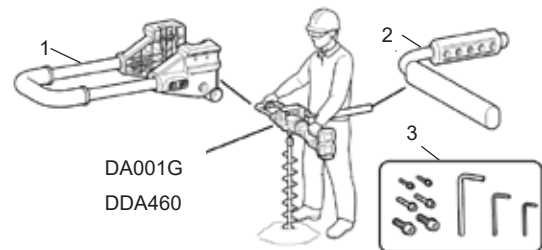

Model No.	Item	Part No.
DA001G, DDA460	1-3set	191P11-3

Earth auger bit adapter

*Use with 191P11-3

Model No.	Item	Part No.
DDG460, DG001G, *DA001G, *DA002G, *DDA460:		327684-2
		327685-0
		327686-8
		327687-6

Tape measure



Feature

1. Special Coating

- * "DURA COAT" makes 5 times more durable
- * "SILICA COAT" makes easier note



2. High durability of Hook

- * Installed damper absorbs the shock on the hook
- * Hook protector reduces the shock on the hook
- * Tightly fixed hook with "4rivets+protector"



3. Convenience

- * 2-sided print
- * Hook with magnet
- * "Matte finish" makes easier to read scales
- * Standout



Makita tape measure is highly durable and convenient. When the scales are blurred or hook is lost, that would be the end of its life. This measure is for professional which has a special coated tape, hook protector and damper which absorbs shocks leads to great durability.

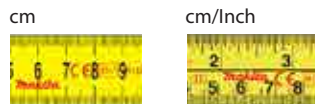

Tape measure with holder & safety cord



Size	Length	Width	Part No.
cm	7.5m	25mm	B-57174

Tape measure



Size	Length	Width	Part No.
cm	2m	13mm	E-03078
cm/inch	2m/6ft	13mm / 1/2"	E-10590



Size	Length	Width	Part No.
cm	3.5m	16mm	B-57130



*North America package

Size	Length	Width	Part No.
cm	5.5m	25mm	B-57146
	7.5m	25mm	B-57152
cm/inch	5.5m/18ft	25mm/1"	*B-57211
	7.5m/25ft	25mm/1"	*B-57227



*North America package

Size	Length	Width	Part No.
cm	10m	25mm	B-57168

Screw driver



Size	Length (mm)	Part No.	
+	PH1	100	B-65903
	PH2	100	B-65919
	PH3	150	B-65931
+	PZ1	80	B-65947
	PZ2	100	B-65953
	PZ3	150	B-65969
*	T10	100	B-65975
	T15	100	B-65981
	T20	100	B-65997
	T25	100	B-66008
	T30	100	B-66014
-	SL4.0	100	B-66020
	SL5.5	100	B-66036
	SL6.5	125	B-66042
	SL8	150	B-66058

Go thru Screw driver



Size	Length (mm)	Part No.	
+	PH1	75	B-66064
	PH2	100	B-66070
	PH3	150	B-66086
+	PZ1	75	B-66092
	PZ2	100	B-66101
	PZ3	150	B-66117
-	SL5.5	75	E-04933
	SL6.5	150	E-04949
	SL8	200	E-04955

Shock driver

Makita shock driver is very useful tool which as a regular handy driver and a shock driver when you work on the stripped screw.



How to remove

1. While applying force in the fastening direction, hold the grip securely.

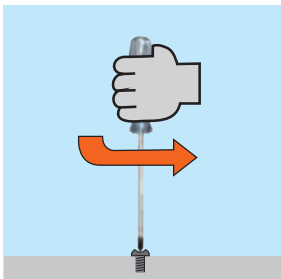

2. Apply strong impact with the hammer.

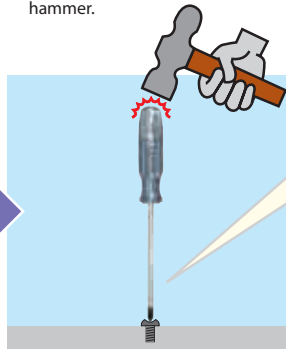

This handy driver can remove both crushed and stripped screws which could not be loosened by the electric tools. Applying the impact on the handle generates a torque in the rotation direction, so both crushed and stripped screws can be removed.



*The impact on the handle generates 12 degrees torque in the loosening direction and even the stripped screw will be loosened.

12 degrees

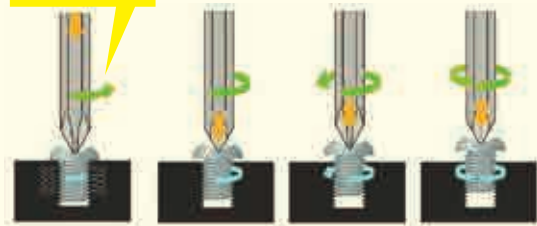

	Size	Length (mm)	Part No.
+	PH2	125	B-42438
	PH3	150	B-42444
+	PZ2	125	B-42450
	PZ3	150	B-42466

Ratchet screwdriver

With screw bit 25mm (PH2)x1pcs.



Part No.
D-58833

Hex key wrench 9pcs. set



Size	Part No.
1.5, 2, 2.5, 3, 4, 5, 6, 8, 10mm	B-65894

Snap-off knife



Part No.
D-58855



Part No.
D-65713

LED Pen Light (without battery)

Battery type: AA



Part No.
D-58752

Strap Belt System

System as a STRAP

Totally New on the market - unique STRAP Belt System with quick release buckles at the ends makes the belt multipurpose. Strap with comfortable soft rubber shoulder pad makes the lifting more comfortable. Fits to all Makita Tool Bags and Cases.



System as a BELT

Strap BELT can be easily detached from any Tool Bag or Tool Case and worn on the waist as a light-duty tool belt. Strap can be adjusted, which is flexible and convenient to fit your need. Can be worn with any Makita Tool Pouch and Holder.



STRAP BELT SYSTEM



Over 45 products within the system

- E-15388** Ultimate Adjustable Tool Case
- E-15394** Reinforced Adjustable Tool Case
- E-15419** Ultimate Covered Tool Tote
- E-15403** Ultimate Open Tool Tote
- E-15447** Ultimate 3-Way Universal Tool Tote
- E-15453** Ultimate 4-Sided Tool Tote
- E-15512** Ultimate Chainsaw Bag
- E-15534** Roll-Top All Weather Tube Bag
- E-15431** Ultimate Wide Mouth Tool Bag
- E-15540** Roll-Top All Weather Duffle Bag
- E-15425** Ultimate Gate Mouth Tool Bag
- E-11782** Ultimate Heavyweight Tool Bag
- E-12712** Ultimate Heavyweight Tool Bag with Trolley
- E-05670** 1M Guide Rail Protective Holder
- E-05664** 1.4M / 1.5M Guide Rail Protective Holder
- E-10920** 1.9M Guide Rail Protective Holder
- E-10936** 3M Guide Rail Protective Holder
- E-15475** Technician Tool & Laptop Bag
- E-15469** Semi-Rigid Tool Bag

- E-15590** Ultimate Lunch Bag & Belt
- E-15556** Ultimate Smartphone Holder
- E-05309** Belt Loop - 3 Pack
- E-05315** Belt Loop - 6 Pack
- E-15338** Tape Measure Holder
- E-15279** Ultimate 4-Way Electricians Holder
- E-15322** Knife / Secateur Holder
- E-15285** Ultimate 3-Way Hammer & Tool Holder
- E-15329** Side Gate Hammer & Tool Holder
- E-15316** Universal Clip Holder
- E-15300** Looped Hammer & Axe Holder
- E-15562** Thermal Flask & Holder
- E-15578** Thermal Mug & Holder
- E-15160** Pencil Driver Holster Universal L/R Handed
- E-15213** Roofer & General Purpose Pouch
- E-15198** Ultimate 2 Pocket Fixing Pouch
- E-15241** Ultimate Electricians Pouch
- E-15154** Drill Holster Universal L/R Handed
- E-15263** Zip Top Pouch - Dual Battery or Fixings
- E-15344** Ultimate Chisel & Tool Holder
- E-15257** Fixing Pouch & Hammer Holder

- E-12980** Ultimate Smartphone Holder XL
- E-15338** Tape Measure Holder
- E-15285** Ultimate 3-Way Hammer & Tool Holder
- E-15316** Universal Clip Holder
- E-15300** Looped Hammer & Axe Holder
- E-15562** Thermal Flask & Holder
- E-15578** Thermal Mug & Holder
- E-15160** Pencil Driver Holster Universal L/R Handed
- E-15213** Roofer & General Purpose Pouch
- E-15198** Ultimate 2 Pocket Fixing Pouch
- E-15241** Ultimate Electricians Pouch
- E-15154** Drill Holster Universal L/R Handed
- E-15263** Zip Top Pouch - Dual Battery or Fixings
- E-15344** Ultimate Chisel & Tool Holder
- E-15257** Fixing Pouch & Hammer Holder

Tool Holders 3rd Generation Technical Solutions



Strap Belt System with quick release buckles at the ends can be easily detached from the Tool Bags and worn on the waist as a light-duty tool belt. Fits all Tool Pouches and Holders as well as Tool Organizers.



3L Technology is a unique 3-layer combination of polyesters and foam that provides extra cushioning. Designed to be tough and weatherproof, these amazingly light polypropylene panels are made up of three composite layers joined securely in a desirable configuration. The innovative feature of these structured core panels means that they can be formed into any shape.



Waterproof Bottom is a high quality solution for tool bags – rigid, wear-resistant and waterproof it keeps tools dry and protected from damp and wet surfaces. The reinforced plastic base also helps you to keep your tool bag clean.



Real Leather is smooth on the outside with brushed suede on the inside. Strong and tough for a long life but soft and supple enough for lasting comfort, whilst providing excellent strength with added abrasion resistance. Heavy gauge leather has been selected for use in products requiring a thicker covering - 1.8 to 2.0mm - ensuring a top quality product.



Durable Riveting gives truly unbreakable strength. Strong one piece self-punching rivets with washers used in all high stress areas. Washers for greater strength in strategical places are used on one or both sides, up and down.



Anti-Slip Solution minimises or even avoids workplace slip and fall accidents. The high quality polypropylene tape has a rubbery surface which helps to keep your tools in place and provides additional protection to help prolong the life of your products.



Elastic Loops secures the contents and keeps your tools in place while carrying. It provides great flexibility for organizing your tools and accessories. Elastic Loops have been applied to a wide variety of our products to ensure that you get maximum usage from your kit. The loops are able to adapt to perfectly suit all tools and accessories.





Side-Gate Solution lets you easily put the tool in without looking at the holder. An additional swing feature ensures your tool is kept at a comfortable angle. Made of stainless steel for product longevity and fixed by four rivets for extra strength.



Pouches & Holders

Descriptions	Outer size			Features								Picture	Part No.
	H	L	W	STRAP-BELT SYSTEM	3 LAYERS	WATERPROOF BOTTOM	REAL LEATHER	DURABLE RIVETING	ANTI SLIP	ELASTIC LOOPS	SIDE-GATE SOLUTION		
Drill Holster Universal L/R Handed	290	170	85	✓	✓		✓	✓	✓	✓			E-15154
Pencil Driver Holster Universal L/R Handed	320	85	60	✓					✓	✓			E-15160
Impact Driver Holster Universal L/R Handed	235	155	75	✓	✓		✓	✓	✓	✓			E-15176
Universal Pouch & Drill Holster L/R Handed	270	260	145	✓	✓		✓	✓	✓	✓			E-15182
Ultimate 2 Pocket Fixing Pouch	270	260	145	✓	✓		✓	✓	✓	✓			E-15198
Ultimate 3 Pocket Fixing Pouch	270	320	145	✓	✓		✓	✓	✓	✓			E-15207
Roofer & General Purpose Pouch	270	290	145	✓	✓		✓	✓	✓	✓	✓		E-15213
3 Pouch Tool Belt Set	270	640	145		✓		✓	✓	✓	✓	✓		E-15229
Ultimate Heavyweight Tool Belt Set	310	880	145	✓	✓		✓	✓	✓	✓			E-15235
Ultimate Electricians Pouch	310	250	125	✓	✓		✓	✓	✓	✓			E-15241
Fixing Pouch & Hammer Holder	185	180	105	✓	✓		✓	✓	✓	✓			E-15257
Zip Top Pouch - Dual Battery or Fixings	185	175	105	✓	✓			✓		✓			E-15263
Ultimate 4-Way Electricians Holder	205	185	55	✓			✓	✓		✓			E-15279
Ultimate 3-Way Hammer & Tool Holder	205	185	85	✓			✓	✓		✓			E-15285
Side Gate Hammer & Tool Holder	165	110	70	✓	✓			✓		✓	✓		E-15291
Looped Hammer & Axe Holder	165	110	65	✓	✓			✓		✓			E-15300
Universal Clip Holder	165	110	15	✓	✓			✓		✓			E-15316

Pouches & Holders

Descriptions	Outer size			Features								Picture	Part No.
	H	L	W	STRAP BELT SYSTEM	3 LAYERS	WATERPROOF BOTTOM	REAL LEATHER	DURABLE RIVETING	ANTI SLIP	ELASTIC LOOPS	SIDE-GATE SOLUTION		
Knife / Secateur Holder	200	100	50	✓	✓			✓	✓	✓			E-15322
Tape Measure Holder	165	110	80	✓	✓			✓	✓	✓			E-15338
Ultimate Chisel & Tool Holder	270	100	60	✓				✓	✓	✓			E-15344



Belts & Braces

Descriptions	Outer size			Features								Picture	Part No.
	H	L	W	STRAP BELT SYSTEM	3 LAYERS	WATERPROOF BOTTOM	REAL LEATHER	DURABLE RIVETING	ANTI SLIP	ELASTIC LOOPS	SIDE-GATE SOLUTION		
Quick Release Belt & Shoulder Strap	38	1300	-	✓									E-15350
Belt Loop - 3 pcs.	129	41	-	✓									E-05309
Belt Loop - 6 pcs.													E-05315
Ultimate Padded Belt with Belt Loop	100	880	30				✓	✓					E-15366
Quick Release Belt & Belt Loop	50	1550	-										E-05337
Ultimate Leather Belt with Belt Loop	48	1380	-				✓						E-15693
Leather Belt Black M	38	1130	-				✓						E-05359
Leather Belt Black L	38	1330	-				✓				E-05365		
Leather Belt Brown M	38	1130	-				✓				E-05371		
Leather Belt Brown L	38	1330	-				✓				E-05387		
Ultimate Padded Braces & Phone Holder	410	520	23						✓				E-15372
Ultimate Braces with Clips	-	50	-										E-05402

Bags & Cases

Descriptions	Outer size (mm)			Features								Picture	Part No.
	H	L	W	STRAP-BELT SYSTEM	3 LAYERS	WATERPROOF BOTTOM	REAL LEATHER	DURABLE RIVETING	ANTI SLIP	ELASTIC LOOPS	SIDE-GATE SOLUTION		
Ultimate Adjustable Tool Case	310	510	300	✓		✓		✓		✓			E-15388
Reinforced Adjustable Tool Case	265	505	295	✓				✓		✓			E-15394
Ultimate Open Tool Tote	355	490	310	✓		✓		✓		✓			E-15403
Ultimate Covered Tool Tote	360	490	310	✓		✓		✓		✓			E-15419
Ultimate Gate Mouth Tool Bag	280	510	295	✓		✓				✓			E-15425
Ultimate Wide Mouth Tool Bag	250	440	240	✓						✓			E-15431
Ultimate 3-Way Universal Tool Tote	225	350	175	✓	✓				✓	✓			E-15447
Ultimate 4-Sided Tool Tote	410	260	220	✓				✓	✓	✓			E-15453
Semi-Rigid Tool Bag	270	520	250	✓	✓				✓	✓			E-15469
Technician Tool & Laptop Bag	350	425	170	✓	✓			✓		✓			E-15475
Backpack Tool Organiser	490	390	230			✓				✓			E-15481
Bucket Tote Tool Organiser	320	470	-							✓			E-15497
Tool Organiser Wrap	195	350	45						✓	✓			E-15506
Ultimate Chainsaw Bag	260	900	270	✓		✓				✓			E-15512
Roll-Top All Weather Backpack	400	330	200						✓				E-15528
Roll-Top All Weather Tube Bag	600	320	320	✓					✓				E-15534
Roll-Top All Weather Duffle Bag	250	610	300	✓					✓				E-15540

Bags & Cases

Descriptions	Outer size (mm)			Features								Picture	Part No.
	H	L	W	STRAP-BELT SYSTEM	3 LAYERS	WATERPROOF BOTTOM	REAL LEATHER	DURABLE REVETTING	ANTI SLIP	ELASTIC LOOPS	SIDE-GATE SOLUTION		
Ultimate Heavyweight Tool Bag	260	650	330	✓									E-11782
Ultimate Heavyweight Tool Bag with Trolley	330	680	330	✓				✓					E-12712

Gear & Equipment

Descriptions	Outer size			Features								Picture	Part No.
	H	L	W	STRAP-BELT SYSTEM	3 LAYERS	WATERPROOF BOTTOM	REAL LEATHER	DURABLE REVETTING	ANTI SLIP	ELASTIC LOOPS	SIDE-GATE SOLUTION		
Ultimate Smartphone Holder	185	100	40	✓	✓						✓		E-15556
Ultimate Smartphone Holder XL	200	115	40	✓	✓						✓		E-12980
Thermal Flask & Holder	200	90	85	✓	✓					✓	✓		E-15562
Thermal Mug & Holder	175	125	100	✓	✓					✓	✓		E-15578
Lunch Bag	210	330	180		✓								E-15584
Ultimate Lunch Bag & Belt	230	330	200	✓	✓	✓				✓			E-15590
Work Vest - Adjustable Pockets	640	510	-								✓		E-15609
Knee Pad Set	240	170	30										E-15615
Ultimate Knee Pad Set	240	170	95										E-05658
1.4M / 1.5M Guide Rail Protective Holder	220	1565	45	✓	✓								E-05664
1M Guide Rail Protective Holder	220	1070	45	✓	✓								E-05670
1.9M Guide Rail Protective Holder	220	1950	45	✓	✓								E-10920
3M Guide Rail Protective Holder	220	3050	45	✓	✓								E-10936

Nails, Staples and Screws Wire coil Nails (Flat Type)



Dia	Length	Shank	Nails/ carton	Part No.
-----	--------	-------	------------------	----------

For Model: AN560, AN611, AN621, AN635H, AN760, AN901, AN902, AN935H, AN953H

2.5mm (0.099")	45mm (1-3/4")	Smooth	10,800	F-30810
	50mm (2")	Screw Chisel	10,800	F-30865
		Smooth	10,800	F-31243

For Model: AN611, AN621, AN635H, AN760, AN901, AN902, AN935H, AN953H, AN960, AN961

2.5mm (0.099")	57mm (2-1/4")	Screw Chisel	8,100	F-30878
		Smooth	8,100	F-31256
	65mm (2-1/2")	Smooth	8,100	F-30900
		Screw Chisel	8,100	F-31269

For Model: AN560, AN611, AN621, AN635H, AN760, AN901, AN902, AN935H, AN953H

2.8mm (0.110")	50mm (2")	Smooth	9,000	F-30823
2.9mm (0.113")		Smooth	9,000	F-30849
2.9mm (0.113")	50mm (2")	Screw Chisel	9,000	F-30971

For Model: AN611, AN621, AN635H, AN760, AN901, AN902, AN935H, AN953H, AN960, AN961

2.9mm (0.113")	57mm (2-1/4")	Screw Chisel	6,750	F-31272
		Screw Chisel	6,750	F-30881
3.1mm (0.120")	65mm (2-1/2")	Smooth	6,075	F-30836
3.3mm (0.131")		Smooth	4,050	F-30852

For Model: AN760, AN901, AN902, AN935H, AN953H, AN960, AN961

2.9mm (0.113")	71mm (2-13/16")	Screw Chisel	6,750	F-31285
3.1mm (0.120")	75mm (3")	Smooth	4,050	F-31298
3.2mm (0.120")	75mm (3")	Screw Chisel	4,050	F-31320

For Model: AN901, AN902, AN935H, AN953H, AN960, AN961

3.4mm (0.135")	75mm (3")	Smooth	3,600	F-31359
----------------	-----------	--------	-------	---------

For Model: AN901, AN902, AN935H, AN953H, AN960, AN961

Dia	Length	Shank	Nails/ carton	Part No.
3.1mm (0.120")	85mm (3-1/4")	Smooth	4,050	F-31304
		Screw Chisel	4,050	F-31333
		Smooth	4,050	F-31317
3.2mm (0.120")	90mm (3-1/2")	Screw Chisel	4,050	F-31346
3.8mm (0.146")		Smooth	2,700	F-31362

Wire coil Nails (Conical Type)

For Model: AN560, AN611, AN635H

Dia	Length	Shank	Nails/ carton	Part No.
2.1mm (0.083")	32mm (1-1/4")	smooth	21,600	F-32766
		smooth	18,000	F-32779
	38mm (1-1/2")	screw	18,000	F-32801

For Model: AN560, AN611, AN621, AN635H, AN760, AN901, AN935H

2.1mm (0.083")	45mm (1-3/4")	smooth	18,000	F-32782
		screw	18,000	F-32814
	50mm (2")	smooth	14,400	F-32795
		screw	14,400	F-32827

Wire coil Nails (Roofing Nail)

(7,200 pcs/box)

For Model:
AN454



Dia	Length	Shank	Nails/ carton	Part No.
3.1mm (0.120")	22mm (7/8")	Smooth	7,200	F-30762
	25mm (1")	Smooth	7,200	F-30775
	32mm (1-1/4")	Smooth	7,200	F-30788
	38mm (1-1/2")	Smooth	7,200	F-30791
	45mm (1-3/4")	Smooth	7,200	F-30807

Paper tape nail clipped-head

For Model:
AN943



Dia	Length	Shank	Finish	Nails/ carton	Part No.
2.9mm (0.113")	60mm (2-3/8")	Smooth	Bright	3,000	F-30566
		Smooth	Bright	3,000	F-30579
3.1mm (0.120")	75mm (3")	Smooth	Galvanized	3,000	F-30582
		Ring	Galvanized	3,000	F-30595
		Smooth	Bright	3,000	F-30601
3.3mm (0.131")	75mm (3")	Smooth	Bright	3,000	F-30614
		Smooth	Galvanized	3,000	F-30627
	83mm (3-1/4")	Smooth	Bright	3,000	F-30630
		Smooth	Galvanized	3,000	F-30643
	90mm (3-1/2")	Smooth	Bright	3,000	F-30656
3.3mm (0.131")	90mm (3-1/2")	Smooth	Galvanized	3,000	F-31645

Pin nail

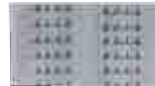

Model No.	Type	Length	Part No.
AF201Z, AF502HP, AF353, DPT351, DPT353, PT354D	23Ga(φ0.6) Pin Nail (10,000 pcs/box)	18mm (11/16")	F-31825
		25mm (1")	F-31838
AF502HP, AF353, DPT351, DPT353, PT354D	23Ga(φ0.6) Pin Nail (10,000 pcs/box)	30mm (1-3/16")	F-31841
		35mm (1-3/8")	F-31854
AF502HP	23Ga(φ0.6) Pin Nail (10,000 pcs/box)	45mm (1-3/4")	F-32920
		50mm (2")	F-32933
AF201Z, AF502HP, DPT351, DPT353, PT354D	23Ga(φ0.6) Stainless Pin Nail (10,000 pcs/box)	18mm (11/16")	F-32142
		25mm (1")	F-32155
AF502HP, DPT351, DPT353, PT354D	23Ga(φ0.6) Stainless Pin Nail (10,000 pcs/box)	30mm (1-3/16")	F-32168
		35mm (1-3/8")	F-32171

Finish Nail

Model No.	Type	Length	Part No.
AF601 DBN600	16 ga Finish Nail (2,000 pcs/box)	25mm (1")	F-33922
		30mm (1-3/16")	F-33935
		32mm (1-1/4")	F-33948
		35mm (1-3/8")	F-33951
		38mm (1-1/2")	F-33964
		40mm (1-9/16")	F-33977
		45mm (1-3/4")	F-33980
		50mm (2")	F-33993
		57mm (1-1/4")	F-34001
		60mm (2-3/8")	F-34014
		64mm (2-1/2")	F-34027
AF635	15Ga Finish Nail 34deg (4,000 pcs/box)	32mm (1-1/4")	F-31960
		38mm (1-1/2")	F-31973
		45mm (1-3/4")	F-31986
		50mm (2")	F-31999
		57mm (1-1/4")	F-32007
		64mm (2-1/2")	F-32010

Brad Nail



Model No.	Type	Length	Part No.
AF506, AF552H, DBN500, DFN350, FN001G	18Ga Brad Nail (5,000 pcs/box)	15mm (5/8")	F-31867
		20mm (3/4")	F-31870
		25mm (1")	F-31883
AF506, DBN500, DFN350, FN001G	18Ga Brad Nail (5,000 pcs/box)	30mm (1-3/16")	F-31896
		32mm (1-1/4")	F-31902
AF506, DBN500, DFN350, FN001G	18Ga Brad Nail (5,000 pcs/box)	35mm (1-3/8")	F-31915
AF506, DBN500, FN001G		38mm (1-1/2")	F-31928
AF506, AF552H, DBN500, FN001G	18Ga Brad Nail (5,000 pcs/box)	40mm (1-9/16")	F-31931
AF506, AF552H, DBN500		45mm (1-3/4")	F-31944
AF506, AF552H, DBN500	18Ga Brad Nail (5,000 pcs/box)	50mm (2")	F-31957
AF552H		55mm (2-3/16")	F-32946

Staple



Model No.	Type	Length	Part No.
DST112 ST113D	10mm(3/8") Crown Staple (5,040 pcs/box) *Japanese package	7mm	F-81518
		10mm	F-81521
DST221	10mm(3/8") Crown Staple (5,040 pcs/box)	10mm (3/8")	F-32647
		13mm (17/32")	F-32650
		16mm (5/8")	F-32663
		19mm (3/4")	F-32676
		22mm (7/8")	F-32689
AT1150A	7/16" Medium Crown Staple 16Ga (10,000 pcs/box)	25mm (1")	F-32078
		28mm (1-1/8")	F-32081
		32mm (1-1/4")	F-32094
		35mm (1-3/8")	F-32100
		40mm (1-9/16")	F-32113
		45mm (3/4")	F-32126
		51mm (2")	F-32139
		22mm (7/8")	F-32197
AT2550A	1" Wide Crown Staple 16Ga (10,000 pcs/box)	25mm (1")	F-32023
		32mm (1-1/4")	F-32036
		38mm (1-1/2")	F-32049
		45mm (1-3/4")	F-32052
		51mm (2")	F-32065

GN900 Accessories

* for Europe, **for Australia

Description	Part No.	Part No.	Part No.
Fuel cell set	*194844-9	**194845-7	195088-4

Concrete pin

Includes one Fuel cell / box.
Box : 10pins/strip x 100 = 1,000pins for Europe



Model No.	Description	Dia. (mm)	Length (mm)	Part No.
GN420C	Premium pin	3.1	15	196285-5
			17	196286-3
			22	196287-1
			27	196288-9
			32	196289-7
	Standard pin	2.6	20	196290-2
			25	196291-0
			30	196292-8
			35	196293-6
			40	196294-4

Concrete pin

1,000 pcs/box



Model No.	Dia. (mm)	Length (mm)	Part No.
AN250HC	2.5	19	F-33562
		22	F-33575
		25	F-33588
	3	19	F-33591

Coil tape collated screws

(2,000 pcs/box)

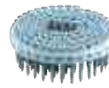

Model No.	Application	Length	Dia	Part No.
AR410HR AR411HR	Drywall to metal stud (Plasterboard to metal stud)	25mm (1")	3.5mm (0.139")	F-34072
		28mm (1-1/8")		F-34085
		41mm (1-5/8")		F-34098
	Drywall to wood (Plasterboard to wood)	25mm (1")	3.8mm (0.146")	F-34104
		28mm (1-1/8")		F-34117
		32mm (1-1/4")		F-34120
		41mm (1-5/8")		F-34133

Brad Nail fuel cell set

Fuel cell/ carton x2 set



Model No.	Type	Length	Part No.
GF600	16Ga Brad Nail Galvanized (2,000 pcs/box)	15mm	195667-8
		19mm	195668-6
		22mm	195669-4
		25mm	195670-9
		30mm	195671-7
		32mm	195672-5
		35mm	195673-3
		38mm	195674-1
		40mm	195675-9
		45mm	195676-7
		50mm	195677-5
		57mm	195678-3
		60mm	195679-1
		64mm	195680-6
		16Ga Brad Nail Stainless (2,000 pcs/box)	25mm
	38mm		195682-2
	50mm		195683-0
			64mm

Depth adjuster set



Model No.	Part No.
DST111, DST112, ST113D, ST313D	197731-1

Magazine set



Model No.	Magazine capacity	Part No.
GN420C	20 pins (2 strips)	196806-3
	40 pins (4 strips)	196805-5

O-rings set

Model No.	Part No.	
AN635H	for duster	196269-3 / 197789-0
	for exhaust hole	197984-2 / 198036-2
	for trigger	199389-2 / 199429-6

Flat Tape Collated Screws

50pcs screws/belt, 1,000pcs screws/box
 *Sorted by the strength for corrosion resistance
 Yes



Drywall Screws

Application	L (mm)	Shank Dia (mm)	Recess	Thread	Finish	Screws /Belt	Screws /Box									Autofeed attachment set	Part No.
								DFR540	DFR550	DFR750	6842	6843	6844	6845			
								25-55mm	25-55mm	45-75mm	25-55mm	25-55mm	45-75mm	25-41mm	25-55mm		
Drywall to metal stud (Plasterboard to metal stud)	25	3.5	PH2	Fine	Phosphated	50pcs	1000pcs		Yes						Yes	F-31227	
	25	3.9	PH2	Fine	Phosphated	50pcs	1000pcs	Yes	Yes		Yes	Yes		Yes	Yes	F-30913	
	30	3.9	PH2	Fine	Phosphated	50pcs	1000pcs	Yes	Yes		Yes	Yes		Yes	Yes	F-30926	
	32	3.5	PH2	Fine	Phosphated	50pcs	1000pcs	Yes	Yes		Yes	Yes		Yes	Yes	F-31018	
	35	3.5	PH2	Fine	Phosphated	50pcs	1000pcs		Yes						Yes	F-31230	
	35	3.9	PH2	Fine	Phosphated	50pcs	1000pcs	Yes	Yes		Yes	Yes		Yes	Yes	F-31153	
	41	3.5	PH2	Fine	Phosphated	50pcs	1000pcs	Yes	Yes		Yes	Yes		Yes	Yes	F-32232	
	41	3.9	PH2	Fine	Phosphated	50pcs	1000pcs	Yes	Yes		Yes	Yes		Yes	Yes	F-31166	
	45	3.9	PH2	Fine	Phosphated	50pcs	1000pcs	Yes		Yes	Yes	Yes		Yes	Yes	F-30939	
55	3.9	PH2	Fine	Phosphated	50pcs	1000pcs	Yes	Yes	Yes	Yes	Yes		Yes	Yes	F-30942		
Drywall to Steel frame (Plasterboard to Steel frame)	35	3.5	PH2	Fine/Self Drilling	Phosphated	50pcs	1000pcs		Yes					Yes	F-31195		
Drywall to wood (Plasterboard to wood)	30	3.9	PH2	Coarse	Phosphated	50pcs	1000pcs	Yes	Yes		Yes	Yes		Yes	F-30955		
	30	3.9	PH2	Coarse	Yellow Zinc (5 micron)	50pcs	1000pcs	Yes	Yes		Yes	Yes		Yes	F-32203		
	33	3.5	PH2	Coarse	Phosphated	50pcs	1000pcs	Yes	Yes		Yes	Yes		Yes	F-31021		
	35	3.9	PH2	Coarse	Phosphated	50pcs	1000pcs	Yes	Yes		Yes	Yes		Yes	F-31179		
	41	3.5	PH2	Coarse	Phosphated	50pcs	1000pcs	Yes	Yes		Yes	Yes		Yes	F-31034		
	41	3.9	PH2	Coarse	Phosphated	50pcs	1000pcs	Yes	Yes		Yes	Yes		Yes	F-31182		
	41	3.9	PH2	Coarse	Yellow Zinc (5 micron)	50pcs	1000pcs	Yes	Yes		Yes	Yes		Yes	F-32216		
	55	3.9	PH2	Coarse	Phosphated	50pcs	1000pcs	Yes			Yes	Yes	Yes		Yes	F-31140	
	55	3.9	PH2	Coarse	Yellow Zinc (5 micron)	50pcs	1000pcs	Yes	Yes	Yes	Yes	Yes	Yes		Yes	F-32229	
Drywall to wood (Plasterboard to hard wood)	30	3.9	PH2	Hi-Low	Yellow Zinc (5 micron)	50pcs	1000pcs	Yes	Yes		Yes	Yes		Yes	F-32245		
	41	3.9	PH2	Hi-Low	Yellow Zinc (5 micron)	50pcs	1000pcs	Yes	Yes		Yes	Yes		Yes	F-32258		
	55	3.9	PH2	Hi-Low	Yellow Zinc (5 micron)	50pcs	1000pcs	Yes	Yes	Yes	Yes	Yes		Yes	F-32261		
Chipboard Screws (Particleboard to wood)	30	4.2	PH2	Coarse, Part Thread	Yellow Zinc (5 micron)	50pcs	1000pcs	Yes	Yes		Yes	Yes		Yes	F-32528		
	42	4.2	PH2	Coarse, Part Thread	Yellow Zinc (5 micron)	50pcs	1000pcs	Yes	Yes		Yes	Yes		Yes	F-32531		
	55	4.2	PH2	Coarse, Part Thread	Yellow Zinc (5 micron)	50pcs	1000pcs	Yes	Yes	Yes	Yes	Yes		Yes	F-32544		
Fermacell Screws (Gypsum Fibreboard to hard wood)	30	3.9	PH2	Hi-Low	Phosphated	50pcs	1000pcs	Yes	Yes		Yes	Yes		Yes	F-31748		
	45	3.9	PH2	Hi-Low	Phosphated	50pcs	1000pcs	Yes	Yes	Yes	Yes	Yes		Yes	F-31751		
Hardboard Screws (HDF board to hard wood)	32	3.9	PH2	Hi-Low	Dacromate	50pcs	1000pcs	Yes	Yes		Yes	Yes		Yes	F-31793		
	41	3.9	PH2	Hi-Low	Dacromate	50pcs	1000pcs	Yes	Yes		Yes	Yes		Yes	F-31809		
Decking Screws (Wood to wood)	42	4.2	PH2	Coarse, Part Thread	Stainless Steel	50pcs	1000pcs	Yes	Yes		Yes	Yes		Yes	F-32470		
	55	4.2	PH2	Coarse, Part Thread	Stainless Steel	50pcs	1000pcs	Yes	Yes	Yes	Yes	Yes		Yes	F-32483		
Wood Screws (Playwood to hard wood)	40	4.2	PH2	Hi-Low	Zinc Plated	50pcs	1000pcs	Yes	Yes		Yes	Yes		Yes	F-31201		
	55	4.2	PH2	Hi-Low	Zinc Plated	50pcs	1000pcs	Yes	Yes	Yes	Yes	Yes		Yes	F-31214		
Wood Screws (Wood to wood)	45	4.2	SQ2	Coarse	Yellow Zinc	50pcs	1000pcs	Yes	Yes	Yes	Yes	Yes			F-33205		
	50	4.2	SQ2	Coarse	Yellow Zinc	50pcs	800pcs	Yes	Yes	Yes	Yes	Yes			F-33218		
Wood Screws (Wood to wood)	41	4.2	SQ2	Coarse	Geomet	50pcs	1000pcs	Yes	Yes		Yes	Yes		Yes	F-33276		
	45	4.2	SQ2	Coarse	Geomet	50pcs	1000pcs	Yes	Yes	Yes	Yes	Yes		Yes	F-33289		
	50	4.2	SQ2	Coarse	Geomet	50pcs	800pcs	Yes	Yes	Yes	Yes	Yes		Yes	F-33292		
	63	4.2	SQ2	Coarse	Geomet	50pcs	600pcs			Yes		Yes			F-33324		
	75	4.2	SQ2	Coarse	Geomet	50pcs	600pcs			Yes		Yes			F-33340		

GN series Accessory

Description	for Europe	for Australia	for North America
	Part No.	Part No.	Part No.
For Model GN900			
Fuel Cell Twin Pack	194844-9	194845-7	195088-4
Cleaner	242075-5	242076-3	242081-0
Lubricating Oil	242077-1	242078-9	242082-8
For Model GN900, GN420C, GF600			
Cleaning Kit	194852-0	194853-8	195140-8
For Model GN900, GN420C			
Service Kit	196234-2	-	-

Air Leak Repair set



Includes O-rings, etc.

Model No.	Part No.
AN450H, AN610H, AN620H, AN630H	194735-4
AF530H, AN510H, AT450H, AT450HA	194736-2
AN250HC, AN711H, AN911H	194737-0
AN923, AN943	194522-1
AR410HR	194738-8

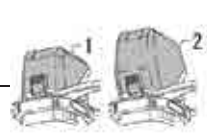

Battery cover

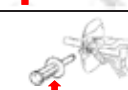
Model No.	Item	Description	Part No.
UT001G UT002G	1	 Battery cover S For battery BL4040	136823-1
	2		

Side Grip / Front cover

Model No.	Item	Part No.
DUT130 DUT131		458814-5
		140G50-6
UT1305, UT2204		152892-4

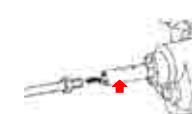

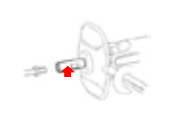
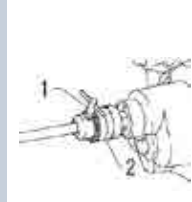
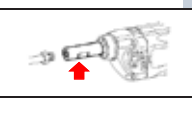
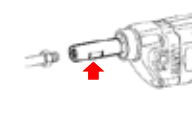







Shaft holder

Model No.	Item	Description	Part No.	
UT001G UT002G		Shaft holder 1/2-M12	327B34-3	
		Shaft holder 1/2-M14	327B35-1	
		1+2	Chuck key set + Chuck 13mm Capacity: 1.5-13mm Thread size: 1/2-20 UNF	193822-6
		1	Chuck key S13 (Handle 80mm)	763183-4
		2	Chuck 13mm	763259-7
DUT130 DUT131		Shaft holder 1/2-M12	458814-5	
		Shaft holder 1/2-M14	140G50-6	
		1+2	Chuck 13mm + Chuck key set Capacity : 1.5-13mm Thread size : 1/2-20 UNF	196008-1
		1	Chuck key S13	763448-4
		2	Chuck 13mm Capacity : 1.5-13mm Thread size : 1/2-20 UNF	766016-2
UT1305		Shaft holder 1/2-M12	323962-8	
UT2204		Shaft holder 5/8-M12	324265-3	
		Shaft holder 5/8-M14	324929-9	





Mixing blade

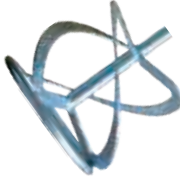
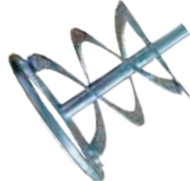

*With Bolt & Nut M8

	Mixing Blade			Bolt		Shaft			Model
	SIZE	Material	Part No.	Bolt Size	Part No.	Bolt Size of Power Mixer	SIZE	Part No.	
	130mm	INOX	A-43670	M8 x 18	265220-5	M12	L=584mm D=12mm	168439-5	DUT130 UT1305
	135mm	Aluminum	A-43723	W5/16 x 16	265475-2	M12	L=584mm D=12mm	A-43773	DUT130 UT1305 UT2204
	150mm	INOX	*A-43686	---	---	M12	L=584mm D=12mm	168439-5	DUT130 UT1305 UT2204
	165mm	INOX	A-43692	M8 x 18	265220-5	M12	L=584mm D=12mm	168439-5	DUT130 UT1305
	175mm	Aluminum	A-43701	W5/16 x 16	265475-2	M12	L=584mm D=12mm	A-43773	UT1305 UT2204
	183mm	Aluminum	A-43739	W5/16 x 16	265475-2	M12	L=584mm D=12mm	A-43773	UT1305 UT2204
	190mm	Steel	A-33065	W5/16 x 16	265475-2	M12	L=584mm D=12mm	A-43773	UT2204
	201mm	Steel	A-33071	W5/16 x 16	265475-2	M12	L=584mm D=12mm	A-43773	UT2204
	220mm	Aluminum	A-43717	M8 x 16	265440-1	M12	L=584mm D=12mm	A-43773	UT2204
	175mm	Aluminum	312D12-8	M8 x 16	265440-1	M12	L=584mm D=12mm	A-43773	UT001G

Mixing paddle

Mixing Paddle type		2 paddle for liquid	3 paddle for quick-drying liquid	2 paddle for viscous material	
Mixing Paddle image					
Feature		 <p>Stir the material from top to bottom.</p> <p>Used for stirring general liquid materials. Since the material is stirred from top to bottom, the material does not easily scatter even when used at high speed.</p>	 <p>Stir the material from top to bottom.</p> <p>Since the material is stirred from top to bottom, the material does not easily scatter even when used at high speed. In addition, the 3-blade has high-efficient mixing capability which reduces mixing time. Therefore, it is suitable for stirring liquid materials with a short curing time.</p>	 <p>Stir the material from bottom to top.</p> <p>Since the material is stirred from bottom to top, it prevents the precipitation of large gravity solids. Ex) Mortar is a mixture of cement, sand and water, so large gravity sand tends to accumulate underneath. Therefore, by stirring the sand on top, it can be mixed efficiently.</p>	
material	liquid	Wall paints	○	○	—
		Dispersions	○	◎	—
		Glazes	◎	—	—
		Varnishes	◎	—	—
		Emulsion paint	◎	—	—
		Epoxy coating	◎	—	—
		Gypsum plaster	—	◎	—
	viscous	Glue	—	—	◎
		Cement laitance	—	—	◎
		Mortar	—	—	◎
		Plaster	—	—	◎

Mixing paddle with 3/8inch Hex shank



Material	Diameter mm	Length mm	Shank Type	For Model	Note	Sales Pkg Qty	Part No.
Liquid	120	600	Straight	Mixer(Max rpm 1,300)	Max mixing weight 15kg	1	D-73536
Viscous material	120	600	Straight	Mixer(Max rpm 500)	Max mixing weight 20kg	1	D-73542

Mixing paddle with M14 shank



Material	Diameter mm	Length mm	Shank Type	For Model	Note	Sales Pkg Qty	Part No.
Liquid	120	600	M14	Mixer(Max rpm 1,300)	Max mixing weight 15kg	1	D-73508
Quick-drying liquid	120	600	M14	Mixer(Max rpm 1,300)	Max mixing weight 18kg	1	D-73520
Viscous material	120	600	M14	Mixer(Max rpm 590)	Max mixing weight 20kg	1	D-73514



Makita - A Global Brand

Makita have established directly operated business bases in about 50 countries around the world, and have upgraded our sales network in over 170 countries and after-sales service capabilities to become one of the leading companies in our industry. In addition, Makita is producing power tools and OPE in China, Romania, Thailand, U.K., Brazil, U.S. and Germany. Currently, about 90% of our group's manufacturing work in terms of production volume is carried out overseas.

Makita's worldwide sales and service network, as well as the stable, high production quality ensured at its plants worldwide, are the embodiment of the Makita brand.

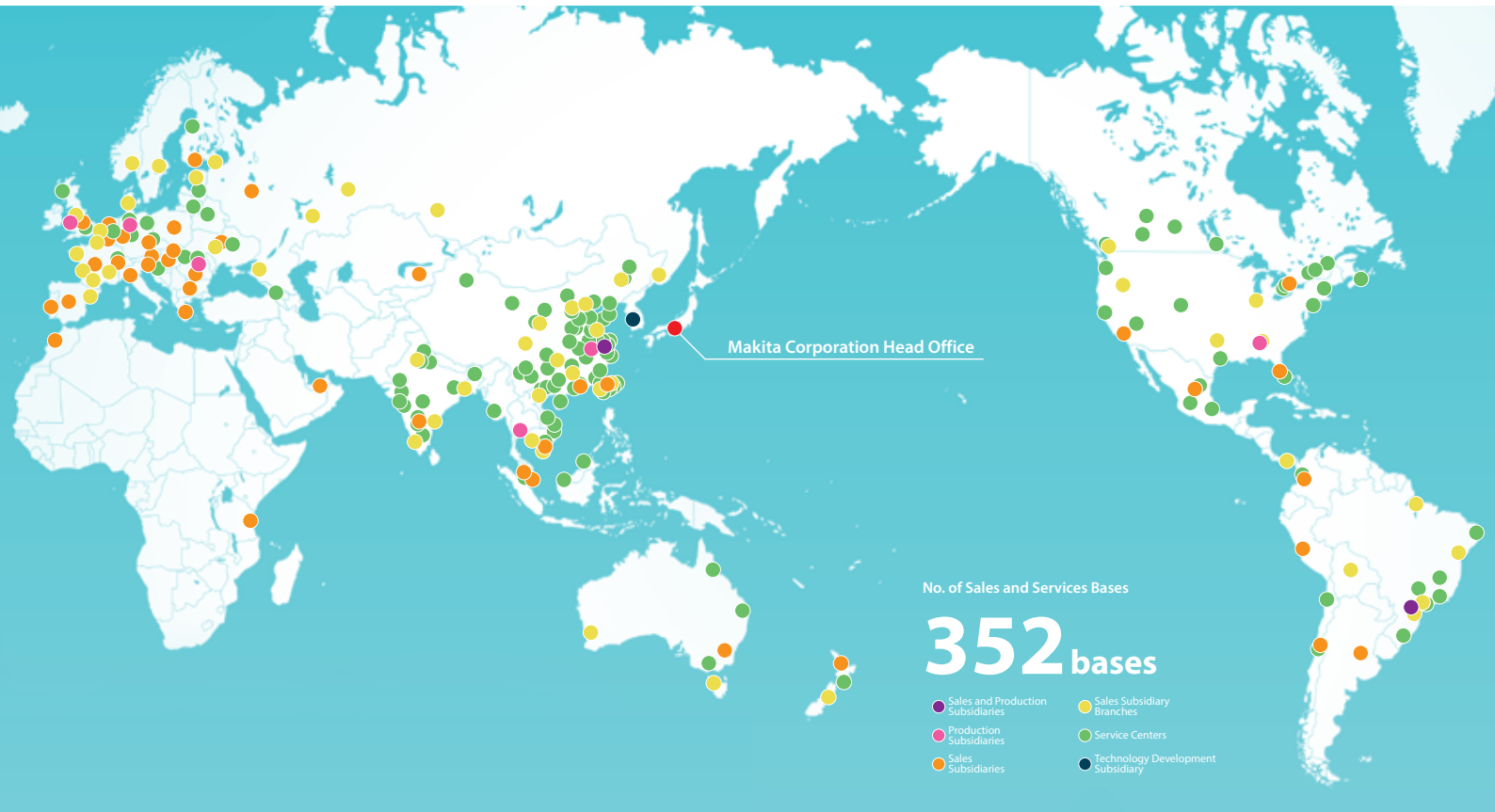

JAPAN

Makita Corporation Headquarters



JAPAN

Okazaki Plant



U.S.A.

U.S. Plant



UNITED KINGDOM

U.K. Plant



ROMANIA

Romania Plant



GERMANY

Germany Plant



BRAZIL

Brazil Plant



CHINA

China Plant (MCC)



CHINA

China Plant (MKC)



THAILAND

Thailand Plant



JAPAN**Makita Corporation****Head office**

3-11-8, Sumiyoshi-cho, Anjo, Aichi
446-8502
Phone: +81-(0)566-98-1711
Fax: +81-(0)566-98-6021
www.makita.co.jp

Okazaki plant

22-1, Watarijima, Nemunoki-cho,
Okazaki, Aichi 444-0232
Phone: +81-(0)564-43-3111

Nisshin Office

349 Minamiyama,
Komenoki-cho, Nisshin,
Aichi 470-0111
Phone: +81-(0)561-75-1500

Tokyo branch office

3-5-3, Hongo, Bunkyo-ku,
Tokyo 113-0033
Phone: +81-(0)3-3816-1141
Fax: +81-(0)3-3813-1633

Nagoya branch office

2-33, Namiki, Nakamura-ku,
Nagoya 453-0856
Phone: +81-(0)52-419-0561
Fax: +81-(0)52-413-0081

Osaka branch office

1-26-8, Tenma, Kita-ku,
Osaka 530-0043
Phone: +81-(0)6-6351-8771
Fax: +81-(0)6-6352-4607

Domestic sales offices

Sapporo, Sendai, Niigata, Utsunomiya,
Saitama, Chiba, Yokohama, Shizuoka,
Gifu, Kanazawa, Kyoto, Hyogo, Okayama,
Hiroshima, Takamatsu, Fukuoka,
Kumamoto, Okinawa and other major
cities

CHINA**Makita (China) Co., Ltd.****Head office & plant (MCC)**

No. 1388 Middle Huangpujiang Road,
Kunshan Economic & Technical
Development Zone, Jiangsu, China
Postcode: 215335
Phone: +86-(0)512-57707710
Fax: +86-(0)512-57713623
www.makita.com.cn

Domestic sales department (MCS/MCCF)

No. 318, South Wusongjiang Road,
Kunshan City, Jiangsu, China
Postcode: 215300
Phone: +86-(0)512-57037500
Fax: +86-(0)512-57037118
www.makita.com.cn

Domestic sales department (MCCS)

No. 80 Meigui Road, Kunshan Economic
& Technical Development Zone, Jiangsu,
China
Postcode: 215300
Phone: +86-(0)512-57567710

Guangzhou sales branch (CGZ)

Rome 1001 1002, The First Floor, Jinhao
Building, No. 38, Middle Of Huadi
Avenue, Li Wan
District, Guangzhou, Guangdong, China
Postcode: 510380
Phone: +86-(0)20-87518872
Fax: +86-(0)20-87518873

Shanghai sales branch (CSH)

Room. 102&103, 1F, No. 128, East Luoxiu
Road, Xuhui District, Shanghai, China
Postcode: 200231
Phone: +86-(0)21-54487198
Fax: +86-(0)21-62476732

Tianjin sales branch (CTJ)

No. 3 Office Building, No. 23, Quanwang
Road, Wuqing Development
Area, Tianjin, China
Postcode: 301700
Phone: +86-(0)22-29395799
Fax: +86-(0)22-29395769

Chengdu sales branch (CCD)

2F, Building 1, Hatchery Building, No. 9, Wu
Ke Dong San Road, Wu Hou
District, Chengdu, Sichuan, China
Postcode: 610045
Phone: +86-(0)28-85366002
Fax: +86-(0)28-87337018

Shenyang sales branch (CSY)

No. 2, 10A, No. 7 Street, Economic and
Technological Development Zone,
Shenyang, Liaoning, China
Postcode: 110141
Phone: +86-(0)24-22530648
Fax: +86-(0)24-22530170

Xian sales branch (CXA)

1 & 2F, Xian Youzhi Science and Technology
Industrial Park No. 75 Mingguang Road,
Economic And Technological Development
Zone, Xian, Shanxi, China
Postcode: 710018
Phone: +86-(0)29-86223736
Fax: +86-(0)29-86229230

Changsha sales branch (CCS)

(Near Gaosheng Road) No. 3, Building
5, Youxin Mechanical And Electrical
Market, Yuhua District, Changsha, Hunan,
China
Postcode: 410114
Phone: +86-(0)731-8526-7792
Fax: +86-(0)731-8526-7791

Shijiazhuang sales branch (CSJ)

No. 15, F District, Wanlian International
Mechanical And Electrical City, No. 560,
Heping East Road, Changan
District, Shijiazhuang, Hebei, China
Postcode: 050000
Phone: +86-(0)311-89864089
Fax: +86-(0)311-85024612

Makita (Kunshan) Co. Ltd.

No. 1, Nanzi Road, Kunshan Economic &
Technical Development Zone,
Jiangsu, China
Postcode: 215300
Phone: +86-(0)512-57367367
Fax: +86(0)512-57365575

Makita Power Tools (HK) Ltd.**Head office**

Unit 1, 17/F., Grandtech Centre,
8 On Ping Street, Shatin, N.T., Hong Kong
Phone: +852-2648-8683
Fax: +852-2648-5237

Macau Service Centre

Em Macau, Rua Do Volong N°11,
RéS-Do-Chão A
Phone: +853-2835-4587
Fax: +853-2835-4135
www.makita.com.hk

Makita (Taiwan) Ltd.**Head office**

No. 798, Sec. 2, Wenhua 3rd Rd.,
Linkou Dist., New Taipei City 24459,
Taiwan
Phone: +886-(0)2-8601-9898
Fax: +886-(0)2-8601-2266
www.makita.com.tw

Taichung sales branch

No. 839, Section 3, Zhongqing Rd, Daya
Dist, Taichung City, 428, Taiwan
Phone: +886-(0)4-2392-1650
Fax: +886-(0)4-2392-1653

Kaohsiung sales branch

No. 105, Yucheng Rd., Sanmin Dist.,
Kaohsiung City 807, Taiwan
Phone: +886-(0)7-343-0292~4
Fax: +886-(0)7-341-3602

Yilan factory service center

No. 237, Section 3, Chuanyi Rd, Luodong
Township, Yilan County, 265, Taiwan
Phone: +886-(0)3-956-7801
Fax: +886-(0)3-956-7877

Hualien factory service center

No. 247, Sec. 2, Zhongyang Rd.,
Ji'an Township, Hualien County 973,
Taiwan
Phone: +886-(0)3-852-8901
Fax: +886-(0)3-852-8515

Yunlin factory service center

No. 197, Guangfu Rd., Huwei Township,
Yunlin County 632, Taiwan
Phone: +886-(0)5-632-8200
Fax: +886-(0)5-632-8190

Tainan factory service center

No. 182, Minzhi Rd, Xinying District,
Tainan City 730, Taiwan
Phone: +886-(0)6-656-5651
Fax: +886-(0)6-656-7800

Pingtung factory service center

No. 12&16, Ruimin Rd.,
Pingtung City 900, Taiwan
Phone: +886-(0)8-722-0001
Fax: +886-(0)8-722-0733

Taitung factory service center

No. 51, Section 2, Zhongxing Rd, Taitung
City, Taitung County 950, Taiwan
Phone: +886-(0)89-232-301
Fax: +886-(0)89-232-322

SINGAPORE**Makita Singapore Pte. Ltd.****Head Office**

7, Changi South Street 3, Singapore 486348
Phone: +65-6546-8700
Fax: +65-6546-8711
www.makita.com.sg

Myanmar Service Center

No. D36/2, Lan Thit Road, Insein Township, Yangon.
Phone: +95-(0)9-76232-6433
+95-(0)9-76911-5388

Cambodia Service Center

No. 432, Street 271, Phum Chamroen
Phal 4, Sangkat Boeung Tumpun 1, Khan
Meanchey, Phnom Penh, CAMBODIA.
Phone: +855-(0)78-994-071
https://www.makita.com.kh/

INDIA**Makita Power Tools India Pvt. Ltd.****Head Office**

Unit 2, Sy. No. 93/3 & 93/4,
Koralur Village, Kasaba Hobli,
Hoskote Taluk, Bangalore – 560067.
India.
Phone: +91-(0)80-2205-8200
Fax: +91-(0)80-2854-9007
www.makita.in

Delhi Branch

Khasra No. 1035, Village Mundka, Near
Ganpati Dharam Kanta, Delhi – 110041,
India
Phone: 011-28341102

Chennai Branch

No. 30, Jawaharlal Nehru Salai,
Koyambedu, Chennai – 600107. India.
Phone: +91-(0)44-2479-2522
Fax: +91-(0)44-2479-2533

Kolkata Branch

P-46, Hide Road Extension,
Kolkata – 700088.
West Bengal. India.
Phone: +91-(0)33-2439-1030 / 1060

Bangalore Service Centre

Sowbhagya M Gopi Nilaya No. 66,
Mission Road, 2nd Main, Sudhamanagar,
Bangalore – 560027. India.
Phone: +91-80-2222-8200

Cochin Branch

Door No. XVI/443A, Jubilee Road, Kerala
– 682040. India
Phone: +91-8590432003

Mumbai Service Centre

Shop No. 3, on Ground Floor,
Commercial Chamber, bearing
Municipal Street No. 76, and 72/80,
Nagdevi Cross Lane, Mumbai 400003.
Phone: +91(0)22-4974-4092

Ahmedabad Service Centre

Aniket Estate, Near Sawan Hotel, Near
Sarkhej – Sanand Chokdi, S. G. Highway,
Ahmedabad – 382210. India.
Phone: +91-6358737996

Hyderabad Service Centre

3-3-10, Kings Way, Rashtra Pathi Road,
Secunderabad – 500003. India.
Phone: +91(0)040-4003-8000

Peenya Service Center

No. 36/B, F1, 2nd Phase, 1st Main Road,
KIADB, NTF Circle, Peenya Industrial
Area, Bangalore – 560058
Phone: +91-9606980302

Pune Service Centre

Shop No. 104, First Floor, Plot No.
PAP/J/121/122. J Block, MIDC Bhoasari,
Pimpri Chinch Wad, Pune – 411026
Phone: 020-46300061

Rudrapur Service Centre

MIG-48, Ground Floor, Ward No. 19, New
Ward no. 38, Near Siddhu Palace, Awas
Vikas, Rudrapur, Uttarakhand – 263153
Phone: +91 7042597756

Trichy Service Centre

No. 4 & 5, No. S1/17A, EGA PLAZA,
Trichy Tanjore Main Road, Thuvakudi,
Trichy – 620015, India
Phone: +91 9600291989

Jamshedpur Service Centre

Shop no. 24, Shivaranjani Complex, Plot
no. ST-8, Mouzadindli, Adityapur,
P.S. Adityapur Ward no. 5, Saraikel (D),
Kharswan, Jharkhand State
Phone: 0657 – 2383024

Indore Service Centre

Unit No. B-34, Block No. B-18, Access B,
New Siyaganj, Poddar Plaza, HTL, Unit 2,
VIP Route No. 1, Kachhi Mohalla, Indore
Phone: 0731-3593608

Vadodara Service Centre

Shop No. 3, Lakod Complex, GIDC,
Makarpara, Vadodara, Gujarat
Phone: Mob. +91 88665 53756

Guwahati Service Centre

Sahani Mansion, Chatribari Road,
Guwahati, Kamrup Metropolitan,
Assam – 781001, India.
Phone: 036-13514572

Coimbatore Service Centre

D.No.138/6, Ground Floor, Rangakonar Street,
Katoor, Coimbatore – 641009, Tamilnadu.
Phone: 0422-3510235

VIETNAM**Makita Vietnam Co. Ltd.****Head office**

Unit 4-5-6, Block 16 18 L1-2, Street 3,
VSIP II Industrial Park, Hoa Phu Ward,
Thu Dau Mot City, Binh Duong Province,
Vietnam.
Phone: +84-274-362-8338
Fax: +84-274-362-8339
www.makita.com.vn

North Branch

Unit 05, No. 01, Street 6, VSIP Bac Ninh
Intergrated Township and Industrial
Park, Phu Chan Ward, Tu Son Town, Bac
Ninh Province, Vietnam
Phone: +84-222-376-5942
Fax: +84-222-376-5941

Da Nang Service Center

102 Trieu Nu Vuong Street, Hai Chau 1
Ward, Hai Chau District, Da Nang City,
Vietnam.
Phone: +84-236-352-5079
Fax: +84-236-352-5479

Can Tho Service Center

366 Vo Van Kiet Street, 5 Zone, An Thoi
Ward, Binh Thuy District, Can Tho City,
Vietnam.
Phone: +84-292-389-4358
Fax: +84-292-389-4359

Buon Ma Thuot Service Center

68 Le Duc Tho, Thang Loi Ward, Buon Ma
Thuot City, Dak Lak Province, Vietnam
Phone: +84-262-355-4556
Fax: +84-262-355-4557

ASIA

Hai Phong Service Center

No. 01 Lot OH-01, Huy Hoang Riverside project, Thuong Ly Ward, Hong Bang District, Hai Phong City, Viet Nam
Phone: +84-225-883-1429/1529

Nha Trang Service Center

Lot 36-38, Road B6, Vinh Diem Trung Urban Area, Vinh Ngoc Ward, Nha Trang City, Khanh Hoa Province, Viet Nam
Phone: +84-258-382-3338

Ho Chi Minh Service Center

12 Trinh Van Can, Cau Ong Lanh Ward, 1 District, Ho Chi Minh City, Viet Nam
Phone: +84-283-821-5191

Ha Noi Service Center

Group 15 and No. 4, Alley 63, Truong Chinh Street, Phuong Liet Ward, Thanh Xuan District, Hanoi City, Viet Nam
Phone: +84-243-202-2585

THAILAND

Makita Manufacturing (Thailand) Co., Ltd.

219/1 Moo 6, Tambol Bowin, Amphur Sriracha, Chonburi, 20230
Phone: +66-3300-4750
Fax: +66-3300-4747

MALAYSIA

Makita Power Tools (Malaysia) Sdn. Bhd.

Head Office
Lot 824, Jalan Subang 5, Subang Industrial Area, 47500 Subang Jaya, Selangor, Malaysia
Phone: +60-(0)3-8023-0824
Fax: +60-(0)3-8022-1448

Johor (Johor Bahru) Service Center

No. 12 & 14, Jalan Rosmerah 2/9, Taman Johor Jaya, 81100 Johor Bahru, Johor
Phone: +60-(0)7-364-9406
Fax: +60-(0)7-364-9407

Sarawak (Kuching) Service Center

Lot 1227, Lorong Demak Indah 2A, Demak Laut Industrial Area, Phase 2A, 93050 Kuching Sarawak, Malaysia.
Phone: +60-(0)82-496-800
Fax: +60(0)82-496-900

Sabah (Kota Kinabalu) Service Center

Lot 19, Jalan Buah Duku, Kolombong Light Industrial Estate, Off Kolombong, Kolombong Zone 1, 88450 Inanam, Kota Kinabalu, Sabah
Phone: +60-(0)88-388-278
Fax: +60-(0)88-388-279

AMERICAS

UNITED STATES

Makita U.S.A. Inc.

Corporate office
14930 Northam Street, La Mirada, CA 90638-5753, USA
Phone: +1-714-522-8088
Fax: +1-714-522-8133
www.makitatools.com

Western regional (Los Angeles) office

14930 Northam Street, La Mirada, CA 90638-5753
Phone: +1-714-522-8088
Fax: +1-714-297-1544

Western regional (Reno) office

10200 Military Rd, Reno, NV, 89506
Phone: +1-775-437-9362

Central regional (Chicago) office

1450 Feehanville Drive, Mount Prospect, IL 60056-6011
Phone: +1-847-297-3100
Fax: +1-847-297-1544

Eastern regional (Atlanta) office

4200 Falcon Parkway Flowery Branch, GA 30542
Phone: +1-770-476-8911
Fax: 866-521-3541 Free Dial USA only

Southern regional (Dallas) office

910 E. Pleasant Run Road, Wilmer, TX 75172
Phone: +1-972-441-8099
Fax: +1-855-231-0468

Factory service centers

Atlanta, Boston, Chicago, Dallas, Denver, Florida, Houston, Las Vegas, Los Angeles, New Jersey, Portland, San Francisco, Reno

Makita Corporation of America

2650 Buford Highway, Buford, GA 30518-6045
Phone: +1-770-932-2901
Fax: +1-770-932-2905

Makita Latin America Inc.

Head office
9221 West 44th Ave. Suite 900, Hialeah, FL 33018
Phone: +1-305-882-0522
Fax: +1-305-882-0484
www.makitalatinamerica.com

Panama Branch

Local Comercial No.4, Albrook Office Center, calle Diego Dominguez, Albrook, Panama City, Panama
Phone: +507-315-0305
Fax: +507-315-0651

CANADA

Makita Canada Inc.

Head office
1950 Forbes Street, Whitby, ON L1N 7B7
Phone: +1-905-571-2200
Fax: +1-905-433-4779
www.makita.ca

Western regional office

11771 Hammersmith Way, Richmond, BC V7A 5H6
Phone: +1-604-272-3104
Fax: +1-604-272-5416

Factory service centers

Burnaby (Vancouver), Calgary, Dartmouth (Halifax), Edmonton, Les Saules (Quebec City), London, Mississauga (Toronto), Nepean (Ottawa), Richmond (Vancouver), Saskatoon, St. Leonard (Montreal), Whitby, Winnipeg

MEXICO

Makita México, S.A. de C.V.

Head office
Camino Viejo A San Lorenzo Tepaltitlan (Jose Marti) No.227 Col. Tlacopa, Toluca, Estado De Mexico, C.P. 50010
Phone: +52-722-385-8800 / 237-3293
www.makita.com.mx

Mexico city factory service center

Norte 35 #780-C Col. Industrial Vallejo, Del. Azcapotzalco Mexico, D.F. Mexico C.P. 02300
Phone: +52-55-5567-3387 / 5368-2937

Guadalajara factory service center

AV.Sierra Mazamitla #5864 Col.Pinar De La Calma Zapopan, Jalisco C.P. 45080
Phone: +52-33-3632-8032 / 3632-8057

Monterrey factory service center

Avenida Pablo Livas #4207 Colonia Guadalupe victoria, Municipio Guadalupe nuevo León, C.P.67180
Phone: +52-81-8372-4205 / 8372-4193

BRAZIL

Makita do Brasil Ferramentas Elétricas Ltda.

Head office & plant
Rodovia BR 376, Km 506,1 - (pista norte) Bairro Colônia Dona Luíza, CEP 84043-450 - Ponta Grossa, PR
Phone: +55-(0)42-3302-2100
Fax: +55-(0)42-3302-2120
www.makita.com.br

São Paulo sales office (MBR)

Rua Makita Brasil, 200 - Bairro Cooperativa - São Bernardo do Campo - SP CEP 09852-080
Phone: +55-(0)11-4392-2411 / 2199-2500
Fax: +55-(0)11-4392-2471

Bahia sales branch

Rua Itagi, 491 - Bairro Pitangueiras - Lauro de Freitas, BA CEP: 42701-370
Phone: +55-(0)71-3252-0154

Critiba service center

Rua Comendador Roseira, 499 Bairro Prado Velho, Curitiba, PR CEP 80215-210
Phone: +55-(0)41-3333-8070

Rio de Janeiro service center

Av. Das Américas, 2250 - Loja J/K - Barra da Tijuca - Rio de Janeiro, RJ CEP:22640-101
Phone: +55-(0)21-3151-7933

Recife service center

Av. Marechal Mascarenhas de Moraes, 630, Bairro Imbiribeira, Recife, PE CEP 51170-000
Phone: +55-(0)81-3428-0210

Belo Horizonte service center

Rua Juiz de Fora, 95 - Bairro Barro Preto, Belo Horizonte, MG CEP 30180-060
Phone: +55-(0)31-2531-2017

Pará Sales Branch

Rodovia BR 316, Km 04 Loja 04-Bairro Águas Lindas, Ananindeua / PA CEP 67020-000
Phone: +55-(0)91-3237-7186

Porto Alegre service center

Av. Sertorio , 5539 - JD. Lindoia - Porto Alegre - RS CEP: 91050-371
Phone: +55-(0)51-3344-1464

Guaixupé service center

Av. Paulo Ribeiro do Valé, 1539 - Japy, Guaixupe - MG, CEP 37800-000
Phone: +55-(0)35-3551-2825

ARGENTINA

Makita Herramientas Eléctricas de Argentina S.A.

LISANDRO DE LA TORRE 1246, PARQUE INDUSTRIAL PILARICA, FATIMA, PILAR PROVINCIA DE BUENOS AIRES, CP1629
Phone: +54 (230)444-1100
Fax: +54 (230)444-1105
www.makita.com.ar

CHILE

Makita Chile Comercial Ltda.

Head Office
AV.EL PARQUE 1307,PARQUE 5,MODULO 12, SECTOR ENEA PONIENTE PUDAHUEL, SANTIAGO,CHILE CP9031244
Phone: +56-2-2540-0400
www.makita.cl

Temuco factory service center

Av. Pedro de Valdivia #0524 , Local 13 y 14, Temuco
Phone: +56-2-2540-0460

Antofagasta factory service center

Pedro Aguirre Cerda 6259, local 3, Antofagasta
Phone: +56-2-2540-0470

PERU

Makita Peru S.A.

Panamericana Sur - Km. 29, Distrito de Lurin, Provincia de Lima Centro de Operaciones "MEGACENTRO LURIN" Locales B1, B23, B24
Phone: +51-(1)-713-1212
www.makita.pe

Bolivia Branch

Av. Japón Nro. 3340 (3er. Anillo externo) entre Av. Alemana y Mutualista
Phone: +59-(1)-3347-1147

COLOMBIA

MAKITA COLOMBIA S.A.S

Head Office
Bodega 3 Lote 123, Centro Empresarial Celta Trade Park, Kilometro 7 Autopista Bogotá-Medellín Funza, Cundinamarca, Colombia
Phone: +57-601-742-9245
www.makita.com.co

Paloquemao factory service center

Carrera 22#18-63, Bogotá, Cundinamarca, Colombia
Phone: +57-601-742-9245 EXT.532

UNITED KINGDOM

Makita (U.K.) Ltd.

Head office

Michigan Drive, Tongwell, Milton Keynes, Bucks MK15 8JD
Phone: +44-(0)1908-211678
Fax: +44-(0)1908-211400
www.makitauk.com

Wigan Warehouse

Challenge Way, Martland Park, Wigan, WN5 0LD
Phone: +44-(0)1908-211678
Fax: +44-(0)1908-211400

Scotland factory service center

Unit 4A, Albion Trading Estate, 750 South Street, Glasgow, G14 0SY
Phone: +44-(0)141-9545861

London factory service center

V5 Vector Park, Forest Road, Feltham, Middlesex, TW13 7EJ
Phone: +44-(0)20-88900586

Makita Manufacturing Europe Ltd.

Hortonwood 7, Telford, Shropshire TF1 7YX
Phone: +44-(0)1952-677688
Fax: +44-(0)1952-677678

FRANCE

Makita France SAS

Head office

37, avenue Graham Bell, ZAC Léonard de Vinci, Bussy Saint-Georges, 77607 Marne-la-Vallée Cedex 3
Phone: +33-(0)1-6094-6400
Fax: +33-(0)1-6094-6380
www.makita.fr

Nantes office

Le Pan Loup, 44220 Couéron
Phone: +33-(0)2-5177-8977
Fax: +33-(0)2-4063-8376

Bordeaux office

137, Rue de la Croix-de-Monjous, 33170 Gradignan
Phone: +33-(0)5-5796-5270
Fax: +33-(0)5-5796-5275

Nord office

Village d'Entreprises, 51, Rue Trémière, 59650 Villeneuve d'Ascq
Phone: +33-(0)3-2059-7020
Fax: +33-(0)3-2047-2220

Dijon office

5, Rue Edmond Voisenet, 21000 Dijon
Phone: +33-(0)3-8054-0880
Fax: +33-(0)3-8054-0881

Lyon office

29 rue Antoine Condorcet, 38090 Villefontaine
Phone: +33-(0)7-8563-8049
Fax: +33-(0)1-60-94-63-86

Toulouse office

15, Rue de Boudeville, Z.I. de Thibaud, 31104 Toulouse
Phone: +33-(0)5-6143-2200
Fax: +33-(0)5-6143-2201

SPAIN

Makita, S.A.

Head office

C/ Juan de la Cierva, 7-15, 28823 Coslada (Madrid)
Phone: +34-91-671-1262
Fax: +34-91-671-8293
www.makita.es

Barcelona Office

Sector ind. La Post c/ Barcelona 3-5 08850 Gavá(Barcelona)
Phone: +34-935-669-124

PORTUGAL

Makita - Ferramentas Electricas, Sociedade Unipessoal, Lda.

portugal sales division

Centro empresarial de Alverca, Vale das Ervas, Armazém C2 2615-187 Alverca do Ribatejo
Phone: +351-219-936-750
Fax: +351-219-574-982
www.makita.pt

ITALY

Makita S.p.A.

Via Don Luigi Sturzo 56/58, Arluno, 20004, Milano, Italy
Phone: +39-0331-524111
Fax: +39-0331-420285
www.makita.it

GREECE

Makita Hellas S.A.

Tatoiou 34, Acharnes, ATTIKI PC13677
Phone: +30-210-8071241
Fax: +30-210-8072245
www.makita.gr

FINLAND

Makita Oy

Teilimäki 4 FIN-01530 Vantaa, Finland
Phone: +358-(09)8578-830
Fax: +358-(0)9-857-88211
www.makita.fi

FSC

Krouvintie 5 90400 Oulu, Finland
Phone: +358 (0)8 -237-48930

ESTONIA

Makita Oy Estonian Branch

Estonian office

Piirimäe 13, 76406 Saku vald, Harjumaa maakond
Phone: +372-6-510-380
Fax: +372-6-510-399
www.makita.ee

LATVIAN

Makita OY Latvian Branch

Latvian factory service center

Vienības gatve 153/1, Mārupes Mārupes nov., LV-2167, LATVIA
Phone: +371 6796 9564
Fax: +371 6796 9564
www.makita.lv

LITHUANIAN

Makita OY Lithuanian Branch

Lithuanian factory service center

L. Zamenhofo Str. 3, Vilnius, LT-06332, LITHUANIA
Phone: +370 5 236 0400
Fax: +370 5 236 0407
www.makita.lt

SWEDEN

Makita Sweden

Bergkällavägen 36A 192 79 SOLLENTUNA SWEDEN
Phone: +46-8-505-819-00
Fax: +46-8-505-819-69
www.makita.se

NORWAY

Makita Norway

Løxaveien 15 1351 Rud Norway
Phone: +47-67 17 69 00
Fax: +47 67 17 69 01
www.makita.no

THE NETHERLANDS

Makita Nederland B.V.

Head office

Park Forum 1101 5657HK Eindhoven
Phone: +31-(0)40-206-4040
Fax: +31-(0)40-206-4096
www.makita.nl

Utrecht Service Center

Straat van Gibraltar 6, 3446CM Woerden
Phone: +31-(0)40-206-4040
Fax: +31-(0)40-206-4096

BELGIUM

S.A. Makita N.V.

Jan-Baptist Vinkstraat 2 3070 Kortenberg
Phone: +32-(0)2-257-1840
Fax: +32-(0)2-253-0101
www.makita.be

Antwerp

Makita FSC Boom Industrieweg 1C 2850 Boom
Phone: +32-(0)2-257-1840

Charleroi Service Center

Avenue de Heppignies 6 6220 Fleurus

GERMANY

Makita Werkzeug GmbH

Head office

Makita Platz 1, 40885 Ratingen
Phone: +49 (0)2102 1004-0
Fax: +49 (0) 2102 1004-128
www.makita.de www.dolmar.de/

Makita Service Center Hamburg

Jenfelder Strasse 51, 22045 Hamburg
Phone: +49 (0) 2102 1004-456
Fax: +49 (0) 2102 1004-493

Makita Service Center Berlin

Gartenfelder Strasse 29 – 37 Gebäude 44, 13599 Berlin
Phone: +49 (0)30 339 756 50

Makita Service Center Lehrte

Everner Strasse 30, 31275 Lehrte
Phone: +49 (0)5132 5042153
Fax: +49 (0)2102 1004475
www.makita.de

Makita Service-Center Groß-Gerau

Hans-Böckler-Str. 22 64521 Groß-Gerau
Phone: +49 (0)6152 9788500
www.makita.de

Makita Logistics Center South Germany

Baumschulenstrasse 1B, 93083 Obertraubling
Phone: +49 (0)2102 1004-410
www.makita.de

Makita Engineering Germany GmbH

Jenfelder Strasse 38, 22045 Hamburg
Phone: +49-(0)40-66986-0
Fax: +49-(0)40-66986-352
www.makita-engineering.de

DENMARK

Makita Elværktøj Danmark

Denmark office

Vegavej 17, 8700 Horsens, Denmark
Phone: +45-76-254400
www.makita.dk

SWITZERLAND

Makita SA

Chemin du Vuasset 7 CH-1028 Preverenges
Phone: +41-(0)21-811-5656
Fax: +41-(0)21-811-5678
www.makita.ch

Espace Mittelland Training Service Center

Lerchenweg 14 CH-4538 Oberbipp
Phone: +41-(0)32 631 01 76
Fax: +41-(0)32 631 01 79

AUSTRIA

Makita Werkzeug Gesellschaft m.b.H.

Airportstraße 4, A-2401 Fischamend
Phone: +43-(0)2232-77700-0
Fax: +43-(0)2232-77700-13
www.makita.at

SLOVENIA

MAKITA.d.o.o.

Brnčičeva 17, SI-1231 Ljubljana-Črnuče, Slovenia
Phone: +386(0) 590 83 600
Fax: +386(0) 590 83 601
www.makita-see.com

CROATIA

Croatia factory service center

Kreše Golika 3A, HR- 10000 Zagreb
Phone: +385 1 2078 252
www.makita-see.com

UKRAINE

Makita Ukraine LLC

61 Oleha Onikiyenka Str., Brovary, Kyiv region 07400, Ukraine
Phone: +38 (044) 494-23-70
+38 (044) 494-23-71
Fax: +38 (044) 494-23-73
www.makita.ua

Dnipro FSC

5 Kursanta Ckorobogatka Str., Dnipro, Dnipropetrovsk region 49124, Ukraine
Phone: +380 (44) 492-27-73

POLAND

Makita Sp. z o.o.

Head office

ul. Bestwińska 103 43-346 Bielsko - Biała
Phone: +48-(0)33-484-0200
Fax: +48-(0)33-818-4059
www.makita.pl

Warsaw branch

Mozzna-Parcela 29 05-840 Brwinów
Phone: +48-(0)22-177-7300

CZECH REPUBLIC

Makita, spol. s r.o.

Kaštanová 555/125d 620 00 Brno
Phone: +42-(0)5-432-16944
Fax: +42-(0)5-432-16946
www.makita.cz

Prague Service Center

K Bílému Vrchu 3040/16, 193 00 Prague 9
Phone: +42-(0)2-991-40585

SLOVAKIA

Makita s.r.o.

Priemyselná 26 974 01 Banská Bystrica
Phone: +421-(0)48-4161-772
Fax: +421-(0)48-4161-769
www.makita.sk

HUNGARY

Makita Elektromos Kíségpértékesítő Kft.

8000 Székesfehérvár, Kukorica utca 7.
Phone: +36-22-507-472
Fax: +36-22-507-484
www.makita.hu

MIDDLE EAST/ AFRICA

ROMANIA

Makita Romania S.R.L.

Str. I.C.Bratianu nr. 164 Depozit Faza 3
077030 Comuna Branesti jud. Ilfov
Romania
Phone: +40 21 569 80 61
+40 21 569 80 62
Fax: +40 21 569 80 59
www.makita.ro

Cluj-Napoca Factory Service Center

Str. Bld. Muncii, Nr. 68, 400641
Cluj, Romania
Phone: +40 21 569 80 61

Iasi Factory Service Center

Boulevard Poitiers No. 2, 700671
Iasi, Romania
Phone: +40 21 569 80 61

SC Makita EU SRL

Str.I.C. Bratianu, nr.164, Comuna Branesti,
jud. ILFOV, ROMANIA 077030
Phone: +40-21-310-7675
Fax: +40-21- 200-0219

BULGARIA

Makita Bulgaria EOOD

Okolovrasten Pat (circle road), No.373,
Sofia 1186, Bulgaria
Phone: +359-2-921-0551
Fax: +359-2-921-0550
www.makita.bg

RUSSIA

Makita LLC

Krasnoproletarskaya street, 4, 1F
Entrance3 ,Moscow 127006
Phone: +7 (495) 109-88-66

MAKITA LLC, Vladivostok branch

83, 1st RABOCHAYA str. ARTEM 692770,
RUSSIA
Phone: +7(423)202-65-23

MAKITA LLC, Novosibirsk branch

15, Dargomyzhskogo str., Novosibirsk,
Russia, 630047
Phone: +7 (383) 209 18 19
Fax: +7 (383) 209 18 19

MAKITA LLC, Samara Branch

3 Mirnaya str., Samara, Russia, 443035
Phone: +7 (846) 202 90 50
+7 (846) 202 42 83

MAKITA LLC, Krasnodar branch

32/2, Turgenevskoe, Takhtamukaisky
district, Adygea Republic, Russia, 385132
Phone: +7 (861) 238 24 97

MAKITA LLC, Yekaterinburg Branch

5, pereulok Avtomatiki, Yekaterinburg,
Russia, 620049
Phone: +7 (343) 286 00 09

BELARUS

MAKITA LLC, Belarus Branch

"Green Plaza",10a, Biruzova str., Minsk,
220073, Belarus
Phone: +375 17 337 1111
www.makita.by

GEORGIA

LTD «Makita Georgia»

64, D. Guramishvili avenue, 0141, Tbilisi,
Georgia
Phone: +995 032 243 06 43

KAZAKHSTAN

Makita Kazakhstan LLP

Kommunalnaya 39, 050016, Almaty,
Kazakhstan
Phone: +7 727 233 0827
Fax: +7 727 382 7921

UNITED ARAB EMIRATES

Makita Gulf FZE

P.O. Box 17133,
Jebel Ali Free Zone, Dubai, UAE
Phone: +971-(0)4-8860-804
Fax: +971-(0)4-8860-805
www.makita.ae

TANZANIA

MAKITA AFRICA LIMITED

P.O. Box 20998,
2nd Floor, Staywell Office Building, Haile
Selassie Road, Msasani Peninsula, Dar es
Salaam, Tanzania
Phone: +255 22 2602870

MOROCCO

MAKITA MOROCCO SARLAU

Rte Zenata Lot Marhaba Show Room N5
Espace Commercial Asteria Amal 5 A S,
20250 Casablanca, Morocco
Phone: +212 522 344808
Fax: + 212 522 355696

OCEANIA

AUSTRALIA

Makita (Australia) Pty. Ltd.

Head office

2 Litton Close Pemulwuy. NSW. 2145
Phone: +61 1300 361 690
Fax: +61 1300 361 770
www.makita.com.au

Hobart office

32a Chapel Street Glenorchy, TAS 7010
Phone: +61 1300 361 690
Fax: +61 1300 361 770

Perth office

374A Kenwick Rd Maddington WA 6109
Phone: +61 1300 361 690
Fax: +61 1300 361 770

Factory Service Center

Sydney, Melbourne, Brisbane, Perth,
Hobart, Townsville

NEW ZEALAND

Makita (New Zealand) Ltd.

Head office

46 Westpoint Drive, Hobsonville,
Auckland 0618
Phone: +64-(0)9-479-8251
Fax: +64-(0)9-479-8259
www.makita.co.nz

Christchurch Office

Unit10, 11, 8 Islington Ave, Christchurch
,8042
Phone: +64-(0)3-930-0500

Factory Service Center

Auckland, Christchurch, Wellington

Accessory Catalogue



Makita Corporation
3-11-8 Sumiyoshi-cho, Anjo, Aichi 446-8502 Japan
www.makita.com